



ABRASIVE PRODUCT SOLUTIONS FOR THE FULL LINE STOCK INDUSTRIAL MARKET

EFFECTIVE | 2015



BONDED ABRASIVES



Depressed Center Wheels **8**
 Small Diameter Cut-off Wheels **18**
 Right Angle Grinder Cut-off Wheels **22**
 Circular Saw Cut-off Wheels **24**
 High-Speed Saw Cut-off Wheels **25**
 Rail Cut-off Wheels **27**
 Walk-Behind Saw Cut-off Wheels **28**
 Chop Saw Cut-off Wheels **29**
 Stationary Saw Cut-off Wheels **32**
 Foundry Cut-off Wheels **33**
 Toolroom Cut-off Wheels **35**
 Metallurgical Cut-off Wheels **37**
 Portable Snagging Wheels, Cones, Plugs **38**
 Floorstand and Swingframe Snagging
 Wheels **41**
 Bench and Pedestal Wheels **43**
 Mounted Points **46**
 Sharpening Stones **51**
 Rubbing Bricks **65**
 Dressing Sticks **296**

NON-WOVEN ABRASIVES



Depressed Center Discs **172**
 Standard Back-up Pad Discs **175**
 Speed-Change and AVOS Discs **176**
 Quick-Change Discs **177**
 Hook and Loop Discs **184**
 Arbor Hole (Gangable) Discs **186**
 Brushes **187**
 Hand Pads, Rolls and Sponges **188**
 Unified Wheels **190**
 Convolute Wheels **195**
 Belts **199**
 Flap Wheels **201**
 Non-Woven Abrasive Basics **204**

DIAMOND TOOLS



Stationary Dressing Tools **248**
 Stationary Fliessen Tools **266**
 Rotary Dressing Tools **269**

DIAMOND AND cBN ABRASIVES



Norton Stock Wheels **280**
 Norton B99 Express Wheels **286**
 CNC Wheels **288**
 Truing Devices **294**
 Truing and Dressing Guide **295**
 Dressing Sticks **296**
 Electroplated Products **299**
 Lapping Compound **310**
 Diamond and cBN Basics **272**

NON-ABRASIVES



Wire Brushes **208**
 Micro-Fiber Cloth Wipes **212**
 Masking Tape **213**

COATED ABRASIVES



Fiber Discs **68**
 Flap Discs **74**
 Paper Discs **81**
 Film and Foam Finishing Discs **92**
 Cloth PSA Discs **94**
 Flexible Diamond Coated Discs **97**
 Quick-Change Discs **98**
 Paper Sheets and Rolls **107**
 Cloth Sheets and Rolls **114**
 Abrasive Sponges **116**
 Flexible Diamond Coated Hand Pads **118**
 File Belts **119**
 Portable Belts **122**
 Narrow Belts **124**
 Wide Belts **130**
 NORaX Belts **133**
 FastTrack Belts **134**
 Flap Wheels and Sand-O-Flex Wheels **136**
 Specialties **148**
 Coated Abrasive Basics **167**

PRECISION PRODUCTION ABRASIVES







Toolroom Vitrified Wheels **220**
 Large Surface Grinding Wheels **232**
 Surface Grinding Segments **233**
 Cylindrical Wheels **235**
 Centerless and Feed Wheels **238**
 Creepfeed Wheel Blank Stock
 FastTrack Service **241**
 Norton Quantum Wheel Blank Stock
 FastTrack Service **242**
 55A Wheel Blank Stock
 FastTrack Service **243**
 Gear Wheel Blank Stock
 FastTrack Service **244**
 Bonded Abrasive Basics **216, 245**

GENERAL INFORMATION

Catalog Navigation **4**
 Coated Abrasive Basics **167**
 Bonded Abrasive Basics **216**
 Bonded Product Specification Key **245**
 Non-Woven Abrasive Basics **204**
 Diamond and cBN Basics **272**
 Safety Guidelines **311**
 Wheel Speed Conversion Table **313**
 Product Warranties **314**
 Trademarks **314**
 Contact Information **315**



RIGHT ANGLE/VERTICAL SHAFT PORTABLE GRINDERS

	Depressed Center Grinding Wheels, Notchers,	8-17
	Saucers and Type 29 Wheels	
	Right Angle Grinder Reinforced Cut-off Wheels,	22-23
	Type 01 and Type 27	
	Coated Abrasive Fiber Discs	68-73
	Coated Abrasive Flap Discs	74-80
	Coated Abrasive Paper Discs	81-91
	Coated Abrasive Film and Foam Finishing Discs	92-93
	Flexible Diamond PSA & Quick-Change Discs	97
	Coated Abrasive Quick-Change Discs	98-106
	Non-Woven Depressed Center Wheels	172-175
	Non-Woven Discs	176-185
	Non-Woven Abrasive Brushes	187
	Wire Brushes	210

HORIZONTAL/STRAIGHT SHAFT PORTABLE GRINDERS

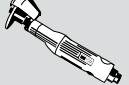
	Small Diameter Reinforced Cut-off	18-21
	Wheels (1-1/2"-6" wheels)	
	Cones and Plugs	38, 40
	Snagging Straight Wheels	38-39
	Mounted Points	46-50
	Coated Abrasive Flap Wheels with	143
	Arbor Holes (3-1/2"-5" wheels)	
	Non-Woven Disc Wheels	186
	Non-Woven Unified Wheels	190-194
	Non-Woven Flap Wheels	201-203
	Wire Brushes	210

RIGHT ANGLE/VERTICAL SHAFT PORTABLE CUP GRINDERS

	Snagging Cup Wheels	38-39
	Wire Cup Brushes	208-209

PORTABLE CIRCULAR SAWS

	Circular Saw Reinforced Cut-off Wheels	24
---	--	----

HAND-HELD GAS OR ELECTRIC SAWS

	High Speed Reinforced Cut-off Wheels	25-26
---	--	-------

RAIL SAWS

	Rail Reinforced Cut-off Wheels	27
---	--	----

WALK-BEHIND SAWS

	Reinforced Cut-off Wheels	28
	Wire Brushes	210

CHOP SAW MACHINES

	Chop Saw Reinforced Cut-off Wheels	29-31
---	--	-------

STATIONARY CHOP STROKE MACHINES

	Large Diameter Reinforced Cut-off Wheels	32
---	--	----



FLEXIBLE SHAFT MOTORS

	Non-Woven Rapid Strip Wheels	190-191
	Non-Woven Unified Wheels	190-194

DRILLS

	Small Diameter Reinforced Cut-off Wheels	18-21
	(2" and 3" wheels with mandrel)	
	Coated Abrasive Small Diameter Flap Wheels	136-142
	Sand-O-Flex Wheels	147
	Non-Woven Surface Stripping & Unified Wheels	190-194

DIE AND PENCIL GRINDERS

	Mounted Points	46-50
	Coated Abrasive Small Diameter Flap Wheels	136-143, 146
	Coated Abrasive Specialties	148-162
	Non-Woven Disc Wheels	186
	Non-Woven Flap Wheels (2"-4" wheels)	201-202
	Non-Woven Surface Stripping and	190-194
	Unified Wheels (1"-4" wheels)	
	Wire Brushes	210-211

BENCH AND PEDESTAL GRINDERS

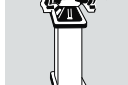
	Vitrified Bench and Pedestal Wheels	43-45
	Coated Abrasive Large Diameter Flap Wheels	143-146
	Sand-O-Flex Wheels	147
	Non-Woven Discs (6"-12" discs)	186
	Non-Woven Unified Wheels (6" wheels)	190-194
	Non-Woven Convolute Wheels (6"-14" wheels)	195-198
	Non-Woven Flap Wheels (6"-8" wheels)	201, 203
	Wire Brushes	209

ORBITAL SANDERS

	Coated Abrasive Paper Discs	81-91
	Film and Foam Finishing Discs	92-93
	Coated Abrasive Small Diameter Cloth PSA Discs	94-95
	Flexible Diamond Coated PSA Discs	97

JITTERBUG SANDERS

	Coated Abrasive Sheets and Rolls	107-115
	Non-Woven Rolls	188-189

STATIONARY DISC SANDERS

	Coated Abrasive Large Diameter Cloth	94, 96
	PSA Discs (10"-24" discs)	

PORTABLE FILE BELT SANDERS

	Coated Abrasive File Belts	119-121, 133
	Non-Woven File Belts	199-200

PORTABLE BELT SANDERS

	Coated Abrasive Portable Belts	122-123
	Non-Woven Portable Belts	199-200

IN-LINE DRUM SANDERS

	Coated Abrasive Portable Belts	122-123
	Non-Woven Portable Belts	199-200

BENCHSTAND GRINDERS

	Coated Abrasive Benchstand Belts.	124-129, 134-135
	Non-Woven Benchstand Belts	199-200

BACKSTAND BELT GRINDERS

	Coated Abrasive Backstand Belts	124-125, 129, 134-135
	Non-Woven Backstand Belts	199-200

HAND FINISHING APPLICATIONS

	Sharpening Stones and Rubbing Bricks	51-65
	Coated Abrasive Paper Discs	91
	Coated Abrasive Sheets, Rolls and Sponges	107-117
	Flexible Diamond Coated Hand Pads	118
	Non-Woven Hand Pads, Rolls and Sponges	188-189
	Wire Brushes	211
	Micro-Fiber Cloths, Masking Tape	212-213

SANDING BOARDS

	Sanding Boards and Coated Abrasive File Strips.	111
---	---	-----

A NON-WOVEN QUICK-CHANGE DISCS



MACHINES USED 

D

B **CATEGORY DEFINITION**

Norton and Merit non-woven quick-change discs are a combination of strong synthetic mesh and quality abrasives, bonded together by a smear-resistant adhesive. They are ideal for use on portable tools to clean and remove imperfections on metal surfaces, clean, debar, or finish a variety of surfaces, blend weld seams, or create decorative finishes. The open construction of the non-woven material enables aggressive cutting action and improved surface finish while maintaining its non-loading feature.

APPLICATIONS: Medium-light stock removal, beveling, deburring/deflashing, rust removal, blending, cleaning and finishing, polishing

SURFACE FINISHING MATERIALS: Surface stripping, surface deburring and blending, surface preparation, buffing, and polishing

MATERIALS: Surface stripping, surface deburring and blending, surface preparation, buffing, and polishing

SIZE RANGE: 3/4" - 8" diameter

GRIT RANGE: X-Coarse, Coarse, Medium, Fine, Very Fine, Super Fine

ABRASIVE GRAIN: Ceramic Alumina, Aluminum Oxide, Silicon Carbide

ATTACHMENT: Quick-Change Type TR (Type III), Type TS (Type II), and Type TP (Type I)

BACK-UP PADS: Rubber with hardness variations for different applications

QUICK-CHANGE ATTACHMENT SYSTEMS AND CROSS REFERENCE GUIDE

Each system enables quick, safe disc changes, reducing downtime and operating expenses.

E **Type TS (Type II)**

- Features a turn-on/turn-off style fastener
- Fastener is made of metal
- Equivalent to Standard Abrasives SocAbr® locking system



Type TR (Type III)

- Features a roll-on/roll-off style fastener
- Fastener is made of plastic
- Equivalent to 3M™ Roloc™ fastening system



Type TP (Type I)

- Features a snap-on/snap-off style fastener
- Fastener is made of nylon



	TS	TR	TP
NORTON			
3M	Roloc TS/TSM	Roloc TR	Roloc TP
Standard	TS (SocAbr)	TR (LockIt)	TP (ClickOn)
Superior	Type S	Type R	-
Arc	Type S	Type R	Type P
Pferd	Type CD	Type CDR	-
Salt	SALT-LOK	SALT-LOK-R	-
Camec	Turn On	Roll On	-
Klingspor	QMC	QPC	-
Garryson	Type S	Type R	-

APPLICATION/GRIT RECOMMENDATION GUIDE

← MOST AGGRESSIVE VORTEX RAPID BLEND VORTEX RAPID PREP RAPID PREP ← LEAST AGGRESSIVE

	BEST CHOICE		SECOND CHOICE
NORTON	RAPID STRIP		HS BUFFING, BUFFING
MERIT	DEBURRING & BLENDING		
SCALE REMOVAL	BEST CHOICE		SECOND CHOICE
STOCK REMOVAL	BEST CHOICE		SECOND CHOICE
HEAVY DEBURRING	SECOND CHOICE		BEST CHOICE
LIGHT DEBURRING	BEST CHOICE		SECOND CHOICE
LIGHT FINISHING	BEST CHOICE		SECOND CHOICE
BLENDING	BEST CHOICE		SECOND CHOICE
CLEANING	BEST CHOICE		SECOND CHOICE
FINISHING	BEST CHOICE		SECOND CHOICE

How Do I Match My End-User Needs?

- F Application recommendations
- G Best / Better / Good performance color coding
- H Full application / grit guide

How Do I Match or Upgrade from a Competitive Product?

- I Cross reference guide

Easy to Follow Page Guide
Key Questions to Simplify Product Selection

Am I in the Right Section?

- A Product
- B Category overview
- C General attributes
- D Correct machine use

How Do I Narrow my Choices?

- E Product design variations

FLAP DISCS

MATERIAL-TO-PRODUCT RECOMMENDATION GUIDE

	BEST Highest Productivity - Lowest Total Cost	BETTER Excellent Blend of Performance & Price	GOOD Consistent Performance - Lowest Total Cost
Type 29 for Stock Removal			
Stainless Steel / Titanium / Super Alloys	Norton Blaze R980P	Norton BlueFire R884P	Norton Neon R766
Mild Carbon Steel / Welds	Norton Red Heat R961	Norton BlueFire R884P	Norton Neon R766
Ferrous Metals / Cast Iron	Norton Red Heat R961	Norton BlueFire R884P	Norton Neon R766
Brass / Bronze / Aluminum	-	Norton BlueFire R884P	-
Type 27 for Blending and Finishing			
Stainless Steel / Titanium / Super Alloys	Norton Blaze R980P	Norton BlueFire R884P	Norton Neon R766
Mild Carbon Steel / Welds	Norton Red Heat R961	Norton BlueFire R884P	Norton Neon R766
Ferrous Metals / Cast Iron	Norton Red Heat R961	Norton BlueFire R884P	Norton Neon R766
Brass / Bronze / Aluminum	-	Norton BlueFire R884P	Norton Neon R766

MACHINE USED 

APPLICATION/GRIT RECOMMENDATION GUIDE

← COARSER (GRINDING) FINER (FINISHING) →

GRIT: 24 36 40 50 60 80 100 120

H **HEAVY STOCK REMOVAL** (Grits 24-36) **EDGE CHAMFERING/DEVELLING** (Grits 36-40) **WELD BLENDING** (Grits 40-50) **DEBURRING/DEFLASHING** (Grits 50-60) **RUST REMOVAL/BLENDING** (Grits 60-80) **CLEANING AND FINISHING** (Grits 80-120)

← STANDARD DENSITY HIGH DENSITY →

CROSS REFERENCE GUIDE

← TOTAL PERFORMANCE INITIAL PRICE →

	BEST Blaze R980P	Red Heat R961	BETTER BlueFire R884P	GOOD Neon R766
NORTON				
3M	94TD	747D	563D, 545D	-
DeWalt	-	-	-	Z/A
Camec	-	CS	Z-Steelless	ZS, AS
Flecevit	-	-	-	Zirconox Premium, Zirconox HP
Garryson	-	-	Zirc, Zirconium	Aluminum Oxide
Gen-Tex	-	Ceramic	-	Zirconia, A/O
Hormen	-	-	-	-
Klingspor	-	-	SMT 630	SMT 618, 619, 624, 626, 627, 628, 640
Metabe	-	-	-	Z/A
Pearl	-	Stainless Max	Zirconia Premium, TuffMax	Z/A Silver Line, Premium A/O Classic, Silver Line
Pferd	-	Ceramic	Cool Zirconia CO-COOL	Zirconia, Cool Aluminum Oxide, Aluminum Oxide
Salt	-	-	-	Z
SIA	-	-	-	Z/A
Standard	-	Ceramic Oxide	Zirconia Pro	Zirconia
Tyrolit	-	-	-	A/O
Walter	-	-	-	-
Weller	-	Saber Tooth Ceramic	-	Tiger Zirconium, A/O, Vortec



What are the Leading Products by Tier?

- J Features and benefits
- K New and/or improved
- L Unique and/or innovative

MACHINE USED

DEPRESSED CENTER WHEELS

FEATURED PRODUCTS

J

K

NORTON METAL/MASONRY
GOOD CHOICE FOR STEEL/FERROUS METAL AND MASONRY APPLICATIONS WITH LOW INITIAL PRICE

FEATURES

- Low initial price point
- Metal – aluminum oxide
- Masonry – sharp silicon carbide

BENEFITS

- Best starting specification for end user unable to measure performance
- Engineered for all steel/ferrous materials
- Engineered for all masonry materials such as concrete, brick and asphalt

NORTON DIALAST DIAMOND WHEELS
BEST FOR METAL PLATE, PIPE, TUBING, CAST IRON, CARBON AND MILD STEEL, FOUNDRY AND WELDING APPLICATIONS, AND CERAMICS

FEATURES

- A combination of high-quality diamond and advanced braided single-layer bonding technology
- Environmentally friendly grinding

BENEFITS

- Extra-long life vs. conventional abrasives or other vacuum-brazed
- Retains the diamond grains and wheel shape for full life with low spark, while keeping a continuous grinding depth
- Less blade changes reduce downtime and labor costs
- Generate minimal dust

L

Norton Fine, Hard Back Depressed Center Wheels Boost Productivity and Wheel Life
Versus Competitors' Monolithic Design (2 coarse layers)

Our fine, hard back (a finer-grit mixture in the top half of the grinding wheel) limits premature shedding or "spalling" and allows for a smoother grinding action from the periphery to the hub.

- At the proper grinding angle, a sharp bevel is produced at the wheel periphery
- As the wheel wears, this thin edge become susceptible to stress
- A coarse grit back is much more likely to break away prematurely resulting in unnecessary wheel loss and quite possibly an injury to operator and others

Norton Depressed Center Adapter Kit

This reusable adapter kit contains everything you need to mount depressed center wheels and saucers with 7/8" center holes on to portable right angle or vertical shaft grinders. Adapter hubs are threaded for mounting on to standard 5/8"-11 NCRH spindles.

KIT NO.	WHEEL DIAMETER	WHEEL THICKNESS	PART #	STD. PKG.
114	6" thru 9"	1/16" thru 1/4"	0760783275	1

VITRIFIED WHEELS

Vitrified Wheels For Steel Applications CONTINUED

AVAILABILITY

M

N

BEST

Norton
NORTON SG
Ceramic Alumina

BETTER

Norton
32A
Aluminum Oxide

GOOD

Norton
38A
Aluminum Oxide

SIZE (D x T x R)	MAX. RPM	MIN. STD. PKG.	SPEC.	PART #	SPEC.	PART #	MIN. STD. PKG.	SPEC.	PART #
Type 11 Flaring Cup									
3/2-1/4 x 1-1/4 x 3/4	7,640	1/10		32A60-JVBE	66243529183	1/10	38A60-JVBE	66243529187	
Rim 1/4" Back 3/8"	7,640	1/10		32A60-KVBE	66243529187				
Face Z (ME1590)									
3-1/2/2-3/4 x 1-1/2 x 1-1/4	7,640	1/10		32A60-KVBE	66243529358				
Rim 1/4" Back 3/8"									
Face Z (ME24327)									
4/3 x 1-1/2 x 1-1/4	5,730	1/10	55G46-KVSP	66243530127	32A46-KVBE	66243530240	1/10	38A46-KVBE	66243530378
Rim 1/4" Back 1/2"	5,730	1/10	55G46-KVVS	66243530342	32A46-KVBE	66243530246	1/10	38A60-JVBE	66243530387
Face Z (ME19237)	5,730	1/10	55G60-KVVS	66243530415	32A60-KVBE	66243530256	1/10	38A60-JVBE	66243530390
	5,730	1/10	55G60-LVS	66243530417	32A60-KVBE	66243530391	1/10	38A80-JVBE	66243530393
	5,730	1/10	55G60-KVVS	66243530419	32A60-KVBE	66243530358	1/10	38A80-KVBE	66243530395
	5,730	1/10	55G60-KVVS	66243530420					
4-1/2/3-3/4 x 2 x 1-1/4	5,730	1/10		32A46-KVBE	66252830639				
Rim 1/4" Back 1/2"									
(ME2019)									
5/2-3/4 x 1-3/4 x 1-1/4	4,585	1/5	55G46-KVVS	66252830291	32A46-JVBE	66252830668	1/5	38A46-KVBE	66252830971
Rim 1/4" Back 1/2"	4,585	1/5	55G60-KVVS	66252830737	32A46-KVBE	66252830859	1/5	38A60-JVBE	66252830973
Face Z (ME1590)	4,585	1/5	55G60-LVS	66252830736	32A60-KVBE	66252830662	1/5	38A60-KVBE	66252830975
	4,585	1/5			32A60-KVBE	66252830664			
6/4-1/2 x 2 x 1-1/4	3,820	1/5			32A46-KVBE	66252838491	1/5	38A46-KVBE	66252838495
Rim 3/8" Back 1/2"	3,820	1/5			32A46-KVBE	66252838528	1/5	38A60-KVBE	66252838497
Face Z (ME19241)	3,820	1/5			32A60-JVBE	66252838492			
7/5 x 2 x 1-1/4	3,275	1/8			32A46-KVBE	66252942959	1/8	38A46-KVBE	66252942963
Rim 3/4" Back 1/2"									
(ME19242)									
Type 12 Dish									
4 x 1/2 x 3/4	6,207	1/10		32A60-KVBE	66243530067				
(ME19296)									
5 x 1/2 x 1-1/4	4,140	1/10	55G60-LVS	66252836574	32A46-JVBE	66252836860	1/10	38A60-JVBE	66252836977
(ME19298)	4,140	1/10		32A60-JVBE	66252836966				
6 x 3/4 x 1-1/4	4,140	1/10	55G60-KVVS	66252837771	32A46-KVBE	66252837732			
(ME19296)	4,140	1/10		32A60-JVBE	66252837734				
	4,140	1/10		32A60-KVBE	66252837735				
7 x 1/2 x 1-1/4	3,600	1/10		32A46-KVBE	66252941644				
(ME13171)	3,600	1/10		32A60-KVBE	66252941647				
8 x 3/4 x 1-1/4	3,600					1/10	38A60-KVBE	66253044319	
(ME19311)									
10 x 1 x 1	2,485	1/-		32A54-JVBE	66253161196				
(ME38702)									
10 x 1 x 1-1/4	2,485	1/-		32A54-JVBE	66253161197				
(ME38702)									
Type 20 Concave One Side									
14 x 1-1/2 x 5	1,800	1/-	55G60-KVVS	66253302265	32A60-JVBE	66253384250			
Concave from Periphery	1,800	1/-			32A60-KVBE	66253384324			
1/2" Deep to 9/16" Flat Spot	1,800	1/-			32A60-LVBE	66253384375			
Type 25 Plate Mounted Disc									
9 x 2 x 4-15/16	2,550	1/-		32A40-KVBE	66253049115				
Rim 2-1/32" (ME31130)	2,550	1/-		32A60-J25VCF2	66253049557				
Plate A4748	2,550	1/-		32A70-JVBE	66253049132				

Professionals Want Choices

already provide the best wheels in the industry. Invented and made in America, now proved and expanded. The Norton NorZon Plus ceramic alumina BEST tier (highest productivity/lowest total cost) line has a wheel for all your right angle grinder applications: NorZon Plus Fast Cut wheels - for your applications requiring the fastest cut rate and quickest project completion. NorZon Plus Long Life wheels - for your most demanding applications. The Original NorZon Plus All Purpose wheels - for the lowest overall cost.

The Choice is Yours!

How Do I Find What I Want Now That I Know What I Want?

- M Visual identification
- N Key product attributes
- O Full specification and product number



a technology leader **FOCUSED ON INNOVATION**

For stock removal, rough blending, grinding and cutting, bonded abrasive products are constructed to tackle the heavy-duty dimensioning work of all material types.



Professionals Want Choices

Norton NorZon Plus is the highest performance line in the industry. Invented and made in America, now improved and expanded. Fastest cutting (FastCut), lowest total cost (All Purpose), and longest lasting (Long Life).

PanAmericanDistribution.com



Performance on Fire

Engineered with a proprietary NorZon grain upgrade, the Norton BlueFire design offers faster removal rate, longer product life and increased productivity for better performance value.



The Right Choice Every Time

The re-engineered Norton Gemini RightCut 100% aluminum oxide wheels provide thinner, faster cutting with a burr-free, precision cut and improved operator comfort.

[Email: panamericandistribution@gmail.com](mailto:panamericandistribution@gmail.com)



CATEGORY DEFINITION

Depressed center wheels may also be referred to as raised hub wheels or by their shape designation of “Type”, with Type 27 being the most popular. The depressed center design allows the flange/lock nut to recess within the wheel so that it can be used for various grinding and cutting applications. Depressed center wheels are designed to handle the most severe right angle grinding applications from heavy stock removal to rough blending. More recently, depressed center wheels have been designed to increase the utility of the tool for cut-off applications. While large right angle grinders (7" & 9") have been around for many years, small or mini grinders that handle 4", 4-1/2" and 5" wheels have made this machine, and wheel category, the most popular in power tools.

- APPLICATIONS:** Grinding, stock removal, edge chamfering, beveling, weld blending, and cutting-off
- SIZE RANGE:** 2" – 9"
- THICKNESS RANGE:** .040 – 1/4"
- GRIT RANGE:** 24 – 46 grits for stock removal; 60, 80 grits for blending and finishing
- ABRASIVE GRAIN:** Ceramic Alumina, Diamond, Zirconia Alumina, Aluminum Oxide, Silicon Carbide
- MOUNTING OPTIONS:** Plain hole (3/8", 5/8" and 7/8") and discard mount (5/8"-11)
- SHAPE:** Type 27, Type 28, Type 29

TYPE-TO-APPLICATION RECOMMENDATION GUIDE

WHEEL TYPE/THICKNESS	APPLICATIONS		
TYPE 27 	Type 27 wheels are essentially straight wheels that have a “depressed center/raised hub”. Different types of fiberglass reinforcement mesh give the product stability for use on the periphery, on the face, or a combination of the two.	 90° ANGLE	 30° ANGLE
.040", .045", and 1/16" Type 27/42 RightCut	Cutting only, where fast cutting and low kerf loss are desired	■	
.3/32" and .125" Type 27/42	For tough cutting and notching applications where stability is important; cutting and cleaning burr-free narrow root pass welds	■	
1/8" Type 27	For multiple applications ranging from cutting-off, notching and light-duty side grinding	■	■
1/8" Pipe Notcher Type 27	2-1/2 pieces of reinforcement; durable face grinding; root pass grinding without removing pipe material	■	■
1/8" Type 27 Flexible	For light stock/blending/finishing/polishing		■
1/8" Type 27 Foundry Notchers	Triple-reinforced for grinding steel and dirty/scale-covered castings; removing and cleaning gates and risers	■	■
1/4" Type 27	For heavy-duty to light grinding on the bottom/face of the wheel		■
1/4" Type 27 Foundry Snaggers	Designed for cleaning parting lines, pads and slag		■
1/4" Type 27 Heavy-Duty Foundry	Triple-reinforced for the most aggressive foundry applications		■
TYPE 28 	Type 28 wheels are constructed with a downward angle built into the grinding section to facilitate a flatter grinding angle. These wheels can only be used on the face and never on the periphery for cutting-off.		 15° ANGLE
1/4" Type 28 Saucers	Smooth, gouge-free grinding at shallow angles		■
TYPE 29 	Type 29 wheels are constructed with an upward angle built into the grinding section to provide full face contact for light stock removal and blending operations. These wheels can only be used on the face and never on the periphery for cutting-off.		 15° ANGLE
1/8" Type 29 Flexible, AVOS	Polishing and blending applications		■



MATERIAL/APPLICATION-TO-PRODUCT RECOMMENDATION GUIDE

	BEST HIGHEST PRODUCTIVITY LOWEST TOTAL COST	BETTER EXCELLENT BLEND OF PERFORMANCE & PRICE	GOOD CONSISTENT PERFORMANCE LOW INITIAL PRICE
Cutting			
Mild Carbon / High Tensile Steel	Norton NorZon Plus	Norton BlueFire	Norton Metal
Stainless Steel / Alloys	Norton NorZon Plus	Norton BlueFire <i>FC/INOX/SS</i>	Norton Gemini <i>INOX/SS</i>
Contaminate Free		Norton BlueFire <i>FC/INOX/SS</i>	Norton Gemini <i>INOX/SS</i>
Cast Iron	Norton NorZon Plus	Norton BlueFire	Norton Gemini
Gray Iron		Norton BlueFire Foundry	
Aluminum / Bronze / Brass			Norton Gemini Aluminum
Asphalt / Brick / Concrete			Norton Masonry
Fiberglass / Plastic			Norton Masonry
Notching			
Mild Carbon / High Tensile Steel	Norton NorZon Plus	Norton BlueFire	Norton Metal
Stainless Steel / Alloys	Norton NorZon Plus	Norton BlueFire <i>FC/INOX/SS</i>	Norton Gemini <i>INOX/SS</i>
Contaminate Free		Norton BlueFire <i>FC/INOX/SS</i>	Norton Gemini <i>INOX/SS</i>
Cast Iron	Norton NorZon Plus	Norton BlueFire	Norton Gemini
Grinding			
Mild Carbon / High Tensile Steel	Norton NorZon Plus	Norton BlueFire	Norton Metal
Stainless Steel / Alloys	Norton NorZon Plus	Norton BlueFire <i>FC/INOX/SS</i>	Norton Gemini <i>INOX/SS</i>
Contaminate Free		Norton BlueFire <i>FC/INOX/SS</i>	Norton Gemini <i>INOX/SS</i>
Cast Iron	Norton NorZon Plus	Norton BlueFire	Norton Gemini
Gray Iron	Norton NorZon Plus Foundry	Norton BlueFire Foundry	Norton Gemini
Aluminum / Bronze / Brass			Norton Gemini Aluminum
Asphalt / Brick / Concrete			Norton Masonry
Blending			
Mild Carbon / High Tensile Steel			Norton Gemini Flexible
Stainless Steel / Alloys			Norton Gemini Flexible
Aluminum / Bronze / Brass			Norton Gemini Flexible
Fiberglass / Plastic			Norton Gemini Flexible

TYPICAL STEEL, STAINLESS STEEL, CAST IRON PRODUCTS: ANGLE IRON, BAR STOCK, DUCTILE PIPE, CHANNEL IRON, DECKING, REBAR, I-BEAMS, RAIL STEEL, STUDS, TUBING, AND WELDS

HOW TO PICK THE RIGHT BOND TYPE

Standard	Unmarked	Where an excellent blend of cut rate and life is needed
Fast Cut	<i>FC</i>	Where fast stock removal is needed, or the application only allows for low-pressure or under-horsepowered grinders
Long Life	<i>LL</i>	Where durability is needed due to severe application, and when horsepower of the grinder allows for heavy pressure
Contaminate Free	<i>INOX/SS</i>	Contain <0.1% iron, sulfur or chlorine for rust-free and corrosion-free results. Will not contaminate stainless steel

HOW TO PICK THE RIGHT MOUNT

Most wheel sizes come with a plain hole or a discard mount option. While the plain hole has a small, initial cost advantage, the discard mount can provide a labor cost advantage with the quicker wheel change.

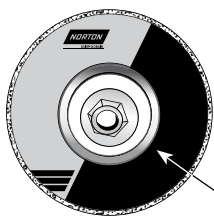

Mini-Mount Hub

Our unique, patented mini-mount hub used on 4-1/2" and 5" depressed center wheels provides up to 30% more wheel life because the hub covers just a small surface area, providing maximum grinding area exposure and usage.

STANDARD THROW-AWAY HUB SIZE

WHY CHOOSE DEPRESSED CENTER WHEELS?

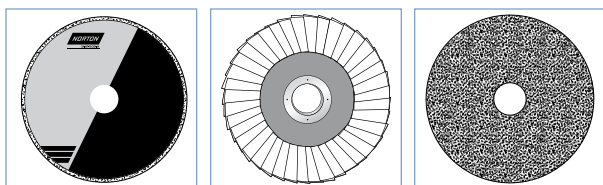

Depressed Center Wheels vs. Flap Discs or Fiber Discs

- Up to 5X life over flap discs, less downtime
- Up to 100X life over fiber discs, less downtime
- Rigidity for severe operations and high power grinders
- 1/8" wheels can be used for cutting and grinding
- Can be used to grind inside corners at outer edge of wheel



CROSS REFERENCE GUIDES

TYPE 27/42 RIGHTCUT – .040" - 1/16"

NORTON	TOTAL PERFORMANCE			INITIAL PRICE			SPECIALTY
	BEST NorZon Plus	BETTER BlueFire	GOOD Gemini INOX/SS	Gemini Long Life	Gemini	Metal	GOOD Gemini Aluminum
Brilliant	—	—	—	Brill-Blade Heavy Duty	Brill-Blade Extra FC	Hornet	—
Bullard	—	ZA60T	—	TA46T, TA60T TA60U	SGA60U	A46T, A60T Comp.	AL46N
Camel	—	ZA Quickie Cut	A60-T-BF, WA60R Quickie Cut	Super Quickie Cut	A36-S-BF	—	A46 Quickie Cut
Flexovit	—	—	—	Razorblade A60SST	Razorblade A24T, 30V, 36T	—	—
Pearl	—	Redline Max Slimcut	—	Slimcut	—	Slimcut Pro-V, Silverline	—
Pferd	—	SGP-ZA-Q-INOX	SG-A-R-INOX, SGP-A-S-INOX	SG-A-S, SGP-A-T	—	PSF-A-P	S-G-N-ALU
Sait	—	Z-tech	XA46R	—	A60S, Saitech	SAIT.M.X	A46N
Spedecut	—	—	—	—	—	A46, 60 TBXX	—
Walter	—	—	A-60SS-ZIP	—	A-60-ZIP, A-30-ZIP	—	A-60-ZIP-ALU

TYPE 27 AND 28 – 1/8" AND 1/4"

NORTON	TOTAL PERFORMANCE					INITIAL PRICE				SPECIALTY	
	BEST NorZon Plus	NorZon Plus Long Life	BETTER BlueFire FC/INOX/SS	BlueFire	BlueFire Foundry	GOOD Gemini	Gemini Fast Cut	Gemini INOX/SS	Metal	GOOD Gemini Aluminum	Masonry
Brilliant	—	—	Brill-Max Z24R	—	—	Brill-Tex A24UHPXL, A30T	Brill-Tex A24R Super-G	Brill-Tex A30P	Hornet Metal	Brill-Tex 30ALU	Brill-Tex C30P, Hornet Concrete
Bullard	TA24S	—	ZA24R	ZA24R Competitor	—	A24R	A24N	A46Q	A24R Competitor	AL36N	C24R
Camel	—	—	ZA24T	—	—	A24R	Ultra A24-N-BF, A24T Super Quickie Cut	WA24S	A24N, R&T Fast Cut	A30N, Fast Cut	C24R
Flexovit	Flexon ZA20Q	Flexon ZA24P ZA30T	—	Metalhog AXT24S	Flexon ZA16U	High Performance A24/30T	High Performance A30S, Specialist A30Q & R	Free Grind A30Q	—	Specialist A24ALU	High Performance C24/30P
Metabo	—	—	ZA24T	—	—	A24R & T	A24N	A360	—	A36M	C24N
Pearl	—	—	Z24T	—	—	Premium Metal A24S, Redline Max A/WA24S	Premium Metal A24R, Redline Max A/WA24R	WA24R, SRT24	Silver Line A24R & S	D.A. Series AL24M	Silver Line C24S
Pferd	—	—	ZA R SGP, Z-SG	ZA S GP, ZA T SGP	—	A-PS, A-SG	—	A-SG INOX, A-PS INOX	—	A-SG ALU	S-SG, Masonry
Sait	Saitech Attacker, Pipeline	Saitech Ultimate Performance	Z24R Z-tech	—	CA24R - Foundry	A24R, A24 Turbo	A24N	XA24Q	—	A46N - Aluminum	C24N
Tyrolit	—	—	ZA24N-BFX	ZA24P-BFX	ZZA24R-BFX	A30S & Q-BFX	A30R-BFX	A30-BF INOX	A30-BF	A36N-BFX WA46-BF	C30-BF
Walter	—	—	Double-X, Allsteel	Allsteel XX	—	HP	—	Stainless	—	Aluminum	Concrete

TYPE 27 – FLEXIBLE 1/8"

NORTON	GOOD Gemini Flex
Brilliant	Brill-Flex
Bullard	Flexlite AC
Camel	FGF, Special Wheel
Flexovit	Flexcel
Metabo	Z-Plus
Pearl	Flexible AC
Pferd	SG-Flex
Sait	Challenger II
Walter	Flexcut



FEATURED PRODUCTS



EXPANDED OFFERING

NORTON NORZON PLUS

BEST/HIGHEST PRODUCTIVITY FOR STEEL, STAINLESS STEEL AND ALL OTHER FERROUS METALS

FEATURES

- Combination of Norton SG ceramic alumina and NorZon (zirconia alumina) with an advanced bond system
- NEW! Fast Cut – fastest cutting
- The original All Purpose – lowest total cost and best overall value
- Long Life – longest lasting
- Foundry Snagger
- RightCut wheels for cutting only

BENEFITS

- 50 to 200% better overall performance versus competitive zirconia and ceramic wheels
- Lowest total grinding cost; highest productivity
- Up to 10X the performance of aluminum oxide wheels
- Easy on the operator and equipment
- Best option when speed of completion is primary concern, cost of labor is high, heavy grinder is used, and grinding is difficult, or performed in hard-to-reach areas
- Best option when the best combination of life, cut rate, and lowest heat generation is primary concern, and able to measure total cost
- Best option when longest possible life is primary concern, rough grinding conditions require wheel durability, using high cycle, high horsepower grinders and lower labor cost are key
- Designed to withstand the most aggressive foundry application
- Noticeably longer life and faster cut rate
- Less pressure required for first cut

**NORTON BLUEFIRE**

BETTER CHOICE FOR STAINLESS STEEL, CARBON STEEL, ALLOYS AND GRAY IRON

FEATURES

- A blend of R&D advanced chemistry and shaped zirconia alumina abrasive and premium aluminum oxide grain
- Contaminate-free BlueFire **FC** (FastCut/Inox/SS)
- BlueFire Foundry
- RightCut wheels for cutting only

BENEFITS

- 2-3 times the life of aluminum oxide wheels
- Up to 20% increase in performance and life over our former zirconia alumina wheels
- Broad utility from light-to heavy-pressure applications, on a wide range of materials
- Excellent performance-to-price ratio for lower total grinding costs
- Contain <0.1% iron, sulfur, or chlorine for rust-free and corrosion-free results; will not contaminate stainless steel
- Zirconia alumina/silicon carbide abrasive blend and an exceptionally strong reinforcement structure
- The ideal choice for aggressive, foundry applications
- Noticeably longer life and faster cut rate
- Less pressure required for first cut



EXPANDED OFFERING

NORTON GEMINI

GOOD CHOICE FOR STEEL AND FERROUS METALS AS WELL AS SPECIALTY APPLICATIONS IN ALUMINUM AND FOUNDRIES

FEATURES

- Quality aluminum oxide
- Gemini Contaminate Free **INOX/SS**
- NEW! 1/8" and 1/4" thick Gemini XXL grinding wheels
- UPGRADED! .045 ultra-thin Gemini RightCut wheels for cutting only
- Gemini Aluminum

BENEFITS

- Consistent performance at a competitive price
- Contain <0.1% iron, sulphur or chlorine for rust-free and corrosion-free results; will not contaminate stainless steel
- Fastest 100% aluminum oxide grinding wheels in the market today
- 50% more life and metal removal than standard aluminum oxide wheels
- Best on hard-grade carbon steel applications, weld repairs, flashing, and any job that requires, a quick turnaround
- Precise cutting; more stability and a narrower pass
- Up to 70% longer life and 20% faster cut rate than standard aluminum oxide wheels – for substantial savings
- Require less pressure, providing increased operator comfort
- Grind aluminum and soft metals without loading
- Contain no wax or rubber fillers



FEATURED PRODUCTS



NORTON METAL/MASONRY

GOOD CHOICE FOR STEEL/FERROUS METAL AND MASONRY APPLICATIONS WITH LOW INITIAL PRICE

FEATURES

- Low initial price point
- Metal – aluminum oxide
- Masonry – sharp silicon carbide

BENEFITS

- Best starting specification for end user unable to measure performance
- Engineered for all steel/ferrous materials
- Engineered for all masonry materials such as concrete, brick and asphalt



NORTON DIALAST DIAMOND WHEELS

BEST FOR METAL PLATE, PIPE, TUBING, CAST IRON, CARBON AND MILD STEEL, FOUNDRY AND WELDING APPLICATIONS, AND CERAMICS

FEATURES

- A combination of high-quality diamond and advanced brazed single-layer bonding technology
- Environmentally friendly grinding

BENEFITS

- Extra-long life vs. conventional abrasives or other vacuum-brazed diamond tools
- Retains the diamond grains and wheel shape for full life with low spark, while keeping a continuous grinding depth
- Less blade changes reduce downtime and labor costs
- Generate minimal dust



Norton Depressed Center Adapter Kit

This reusable adapter kit contains everything you need to mount depressed center wheels and saucers with 7/8" center holes on to portable right angle or vertical shaft grinders. Adapter hubs are threaded for mounting on to standard 5/8"-11 NCRH spindles.

KIT NO.	WHEEL DIAMETER	WHEEL THICKNESS	PART #	STD. PKG.
114	6" thru 9"	1/16" thru 1/4"	07660789275	1

DEPRESSED CENTER WHEEL DESCRIPTION CODES

BLANK = ALL PURPOSE	FC = FAST CUT	HD = HEAVY DUTY	INOX/SS = CONTAMINANT FREE	LL = LONG LIFE	1-2-3 = CUTTING/NOTCHING/GRINDING
ALU = ALUMINUM	FOUN = FOUNDRY	MASON = MASONRY	STAIN = STAINLESS	STEEL = STEEL / METAL	

Professionals Want Choices



We already provide the best wheels in the industry. Invented and made in America, now improved and expanded. The **Norton NorZon Plus** ceramic alumina BEST tier (highest productivity/lowest total cost) line has a wheel for all your right angle grinder applications:

- NorZon Plus Fast Cut wheels - for your applications requiring the fastest cut rate and quickest project completion
- NorZon Plus Long Life wheels - for your most demanding applications
- The Original NorZon Plus All Purpose wheels - for the lowest overall cost

The Choice is Yours!



AVAILABILITY



TIER:	BEST	BETTER	GOOD	GOOD
TRADENAME:	NORTON NORZON PLUS	NORTON BLUEFIRE	NORTON GEMINI	NORTON METAL
SHAPE:	Type 27/42	Type 27/42	Type 27/42	Type 27/42
ABRASIVE:	Ceramic Alumina/ Zirconia Alumina	Zirconia Alumina/ Aluminum Oxide	Aluminum Oxide	Aluminum Oxide
MATERIAL:	STAINLESS STEEL/METAL	STAINLESS STEEL/METAL	STAINLESS STEEL/METAL	STAINLESS STEEL/METAL

SIZE (D x T x H)	MAX. RPM	STD. PKG.	PART #	PART #	PART #	PART #
.040, .045, 1/16" – RightCut Cut-off – Type 27/42						
4 x .045 x 5/8	15,280	25			66252842180	07660705249
4-1/2 x .040 x 5/8-11	13,580	10		66252843227		
4-1/2 x .045 x 5/8-11	13,580	10	66252842006	66252843223	66252842025	
	13,580	10			66252841913 INOX/SS	
4-1/2 x .045 x 7/8	13,580	25	66252843320	66252843219	66252842026	66252843604
	13,580	25			66252841912 INOX/SS	
	13,580	25*			66252842161 5-Pk	
	13,580	250			66253370065 250-Pk	
5 x .040 x 5/8-11	12,225	10		66252843228	66252841939	
5 x .045 x 5/8-11	12,225	10			66252841915 INOX/SS	
	12,225	10			66252842036	66252843849
5 x .045 x 7/8	12,225	25	66252843329	66252843220	66252841914 INOX/SS	
	12,225	25			66252842171 5-Pk	
	12,225	25*			66253370066 250-Pk	
	12,225	250			66252830587	
6 x .045 x 5/8-11	10,185	10	66252842007		66252841917 INOX/SS	
	10,185	10			66252842202	66252842015
6 x .045 x 7/8	10,185	25	66252842009	66252843221	66252841916 INOX/SS	
	10,185	25			66252842176 5-Pk	
	10,185	25*			66253370067 250-Pk	
	10,185	250			66252841919 INOX/SS	
7 x .045 x 5/8-11	8,600	10			66252912626	
7 x .045 x 7/8	8,600	20			66252841918 INOX/SS	
	8,600	20				07660705251
7 x 1/16 x 7/8	8,600	10				
9 x 1/16 x 5/8-11	6,600	10			66253019115	

RIGHTCUT WHEELS ARE TO BE USED FOR CUTTING ONLY.

SIZE (D x T x H)	MAX. RPM	STD. PKG.	PART #	PART #	PART #	PART #
3/32", .125" – Cut-off – Type 27/42						
4 x .125 x 3/8	15,280	25	66252842001			66252842014
4 x .125 x 5/8	15,280	25				
4-1/2 x 3/32 x 5/8-11	13,580	10			66252841903	
	13,580	10			66252842027 INOX/SS	
4-1/2 x 3/32 x 7/8	13,580	25			66252841940	
	13,580	25			66252842028 INOX/SS	
	13,580	25			66252843582 1-2-3	
4-1/2 x .125 x 5/8-11	13,580	10	66252843321		66252843588	66252843609
4-1/2 x .125 x 7/8	13,580	25	66252843322		66252843589	66252843611
5 x 3/32 x 5/8-11	12,225	10			66252841904	
5 x 3/32 x 7/8	12,225	25			66252842037 INOX/SS	
	12,225	25			66252843587 LL	
	12,225	25			66252843583 1-2-3	
5 x .125 x 5/8-11	12,225	10				66252843615
5 x .125 x 7/8	12,225	25			66252843595	66252843616
6 x 3/32 x 5/8-11	10,185	10			66252841905	
6 x 3/32 x 7/8	10,185	25			66252841906	
	10,185	25			66252832487 INOX/SS	
6 x .125 x 5/8-11	10,185	10			66252841192	
6 x .125 x 7/8	10,185	25			66252842021	
7 x 3/32 x 5/8-11	8,600	10			66252841907	
7 x 3/32 x 7/8	8,600	20			66252841908	
	8,600	20			66252914638 INOX/SS	
7 x .125 x 5/8-11	8,600	10	66252912625			
7 x .125 x 7/8	8,600	20	66252912624		66252900619	
	8,600	25*				07660775956 5-Pk
9 x 3/32 x 5/8-11	6,600	10		66252842378		
9 x 3/32 x 7/8	6,600	20		66252842343		

THESE WHEELS ARE TO BE USED FOR CUTTING ONLY.

* 5-WHEEL JOB PACKS; WHEELS ARE PACKED 5 WHEELS/PACK, WITH 5 JOB PACKS/CARTON. ORDER PER EACH WHEEL IN STANDARD PACKAGE QUANTITIES OF 25. ORDER IN MULTIPLES OF 25.

See .045" RightCut Wheels for Aluminum on page 17.



AVAILABILITY



TIER:	BEST	BETTER	GOOD	GOOD
TRADENAME:	NORTON NORZON PLUS	NORTON BLUEFIRE	NORTON GEMINI	NORTON METAL
SHAPE:	Type 27/42	Type 27/42	Type 27/42	Type 27/42
ABRASIVE:	Ceramic Alumina/ Zirconia Alumina	Zirconia Alumina/ Aluminum Oxide	Aluminum Oxide	Aluminum Oxide
MATERIAL:	STAINLESS STEEL/METAL	STAINLESS STEEL/METAL	STAINLESS STEEL/METAL	STAINLESS STEEL/METAL

SIZE (D x T x H)	MAX. RPM	STD. PKG.	PART #	PART #	PART #	PART #
1/8", 5/32" – Pipe Notching – Type 27						
4-1/2 x 1/8 x 5/8-11	13,580	10			66253370272	XXL
4-1/2 x 1/8 x 7/8	13,580	25			66253370271	XXL
5 x 1/8 x 5/8-11	12,225	10			66253370273	XXL
5 x 1/8 x 7/8	13,580	25			66252842038	XXL
6 x 1/8 x 5/8-11	10,185	10			66252841193	XXL
6 x 1/8 x 7/8	10,185	20			66252835580	XXL
7 x 1/8 x 5/8-11	8,600	10	66252939184		66253370274	XXL
7 x 1/8 x 7/8	8,600	20			66252835581	XXL
9 x 1/8 x 5/8-11	6,600	10	66253049066		66253370275	XXL
9 x 1/8 x 7/8	6,600	20			66253370276	XXL

PIPE NOTCHERS ARE TO BE USED FOR CUTTING/NOTCHING ONLY.

AVAILABILITY



TIER:	BEST	BETTER	GOOD	GOOD
TRADENAME:	NORTON NORZON PLUS	NORTON BLUEFIRE	NORTON GEMINI	NORTON METAL
SHAPE:	Type 27 and Type 28	Type 27 and Type 28	Type 27 and Type 28	Type 27
ABRASIVE:	Ceramic Alumina/ Zirconia Alumina	Zirconia Alumina/ Aluminum Oxide	Aluminum Oxide	Aluminum Oxide
MATERIAL:	STAINLESS STEEL/METAL	STAINLESS STEEL/METAL	STAINLESS STEEL/METAL	STAINLESS STEEL/METAL

SIZE (D x T x H)	MAX. RPM	STD. PKG.	PART #	PART #	PART #	PART #
1/8" – Cutting / Notching / Light Grinding – Type 27						
3 x 1/8 x 3/8	18,000	25	66252842177			
4 x 1/8 x 3/8	15,280	25	66252842004	66252843178	66252842016	
4 x 1/8 x 5/8	15,280	25	66252842005	66252843176	66252842017	
4-1/2 x 1/8 x 5/8-11	13,580	10	66252843323	66252843211	66252843590	
	13,580	10		66252843191 FC/INOX/SS		
	13,580	10 V			66252842166 2-Pk	
4-1/2 x 1/8 x 7/8	13,580	25	66252843324	66252843212	66252843591	
	13,580	25		66252843190 FC/INOX/SS		
	13,580	10 V			66252842167 2-Pk	
5 x 1/8 x 5/8-11	12,225	10	66252843330	66252843215		
	12,225	10		66252843195 FC/INOX/SS		
5 x 1/8 x 7/8	12,225	25	66252843331	66252843216	66252843596	
	12,225	25		66252843194 FC/INOX/SS		
6 x 1/8 x 5/8-11	10,185	10	66252841891	66252843199 FC/INOX/SS	66252833965	
6 x 1/8 x 7/8	10,185	20		66252843202	66252801864	
	10,185	20		66252843198 FC/INOX/SS		
7 x 1/8 x 5/8-11	8,600	10	66252938855	66252843233	66252939259	07660702678
	8,600	10		66252843183 FC/INOX/SS		
7 x 1/8 x 7/8	8,600	20	66252938854	66252843234	66252939207	
	8,600	20		66252843182 FC/INOX/SS		
	8,600	25*				
9 x 1/8 x 5/8-11	6,600	10	66253048897	66252843244	66253048983	
	8,600	10		66252843187 FC/INOX/SS		
9 x 1/8 x 7/8	6,600	20	66253048896	66252843245	66253048994	
	6,600	20		66252843186 FC/INOX/SS		

* 5-WHEEL JOB PACKS; WHEELS ARE PACKED 5 WHEELS/PACK, WITH 5 JOB PACKS/CARTON. ORDER PER EACH WHEEL IN STANDARD PACKAGE QUANTITIES OF 25. ORDER IN MULTIPLES OF 25.

V NEW! VENDIBLE 2-WHEEL PACKAGE. IDEAL FOR VENDING MACHINGS AND SMALL JOBS. 5 PACKS/CARTON. ORDER IN MULTIPLES OF 10.



AVAILABILITY



TIER:	BEST	BETTER	GOOD	GOOD
TRADENAME:	NORTON NORZON PLUS	NORTON BLUEFIRE	NORTON GEMINI	NORTON METAL
SHAPE:	Type 27 and Type 28	Type 27 and Type 28	Type 27 and Type 28	Type 27
ABRASIVE:	Ceramic Alumina/ Zirconia Alumina	Zirconia Alumina/ Aluminum Oxide	Aluminum Oxide	Aluminum Oxide
MATERIAL:	STAINLESS STEEL/METAL	STAINLESS STEEL/METAL	STAINLESS STEEL/METAL	STAINLESS STEEL/METAL

SIZE (D x T x H)	MAX. RPM	STD. PKG.	PART #	PART #	PART #	PART #
1/4" - Grinding - Type 27						
3 x 1/4 x 3/8	18,000	25	66252842178		66252842179	
4 x 1/4 x 3/8	15,280	25	66252842002	66252843179	66252842018	
4 x 1/4 x 5/8	15,280	25	66252842003	66252843177	66252842020 FC	66252842011
	15,280	25			66252842019	
4-1/2 x 3/16 x 7/8	13,580	25	66252843325		66252843592	
4-1/2 x 1/4 x 5/8-11	13,580	10	66252843326	66252843213	66252843593	66252843605
	13,580	10	66252843327 LL	66252843193 FC/INOX/SS	66252843585 FC	
	13,580	10	66252843796 FC		66252842032 INOX/SS	
	13,580	10			66252843785 XXL	
	13,580	40				66252819559
	13,580	10 V	66252829541 2-Pk	66252842162 2-Pk	66252842163 2-Pk	
4-1/2 x 1/4 x 7/8	13,580	25	66252843328	66252843214	66252843594	66252843607
	13,580	25	66252843795 FC	66252843192 FC/INOX/SS	66252843584 FC	
	13,580	25			66252842033 INOX/SS	
	13,580	25			66252843784 XXL	
	13,580	50				66252836796
	13,580	10 V	66252829540 2-Pk	66252842164 2-Pk	66252842165 2-Pk	
5 x 1/4 x 5/8-11	12,225	10	66252843332	66252843217	66252843597	66252843613
	12,225	10	66252843333 LL	66252843197 FC/INOX/SS	66252843787 XXL	
	12,225	10	66252843798 FC			
5 x 1/4 x 7/8	12,225	25	66252843334	66252843218	66252843598	66252843614
	12,225	25	66252843797 FC	66252843196 FC/INOX/SS	66252843586 FC	
	12,225	25			66252842040 INOX/SS	
	12,225	25			66252843786 XXL	
	12,225	10 V			66252842172 2-Pk	
6 x 1/4 x 5/8-11	10,185	10	66252841920	66252843224	66252832390	
	10,185	10	66252843800 FC	66252843201 FC/INOX/SS	66252843789 XXL	
6 x 1/4 x 7/8	10,185	20	66252809376	66252843203	66252801865	
	10,185	20	66252843799 FC	66252843200 FC/INOX/SS	66252843788 XXL	
7 x 1/4 x 5/8-11	8,600	10	66252917881	66252843235	66252940147 FC	66252912633
	8,600	10	66252835578 LL	66252843185 FC/INOX/SS	66252940148 LL	
	8,600	10	66252843802 FC		66252843791 XXL	
	8,600	25*				07660775940 5-Pk
7 x 1/4 x 7/8	8,600	20	66252917880	66252843236	66252940099 FC	
	8,600	20	66252843801 FC	66252843184 FC/INOX/SS	66252940098 LL	
	8,600	20			66252843790 XXL	
	8,600	25*				07660775936 5-Pk
9 x 1/4 x 5/8-11	6,600	10	66253021634	66252843246	66253049105 FC	
	6,600	10	66252830728 LL	66252843189 FC/INOX/SS	66253049104 LL	
	6,600	10	66252843804 FC		66252843793 XXL	
	6,600	25*				07660775938 5-Pk
9 x 1/4 x 7/8	6,600	20	66253021633	66252843247	66253049077 FC	
	6,600	20	66252843803 FC	66252843188 FC/INOX/SS	66253048991 LL	
	6,600	20			66252843792 XXL	

* 5-WHEEL JOB PACKS; WHEELS ARE PACKED 5 WHEELS/PACK. WITH 5 JOB PACKS/CARTON. ORDER PER EACH WHEEL IN STANDARD PACKAGE QUANTITIES OF 25. ORDER IN MULTIPLES OF 25.
V NEW! VENDIBLE 2-WHEEL PACKAGE. IDEAL FOR VENDING MACHINES AND SMALL JOBS. 5 PACKS/CARTON. ORDER IN MULTIPLES OF 10.

DEPRESSED CENTER WHEEL DESCRIPTION CODES

BLANK = ALL PURPOSE **FC** = FAST CUT **HD** = HEAVY DUTY **INOX/SS** = CONTAMINANT FREE **LL** = LONG LIFE **1-2-3** = CUTTING/NOTCHING/GRINDING
■ = ALUMINUM **■** = FOUNDRY **■** = MASONRY **■** = STAINLESS **■** = STEEL / METAL



AVAILABILITY



TIER:	BEST	BEST	BETTER	GOOD
TRADENAME:	NORTON NORZON PLUS	NORTON DIALAST	NORTON BLUEFIRE	NORTON GEMINI
SHAPE:	Type 28	Type 29 and Reversible	Type 28	Type 28
ABRASIVE:	Ceramic Alumina/ Zirconia Alumina	Diamond	Zirconia Alumina/ Aluminum Oxide	Aluminum Oxide
MATERIAL:	STAINLESS STEEL/METAL	STAINLESS STEEL/METAL	STAINLESS STEEL/METAL	STAINLESS STEEL/METAL

SIZE (D x T x H)	MAX. RPM	STD. PKG.	PART #	PART #	PART #	PART #
1/4" - Grinding - Type 28 Saucer						
7 x 1/4 x 5/8-11	8,600	10	66252905369		66252843229	66252940149
			66252844345 FC			
7 x 1/4 x 7/8	8,600	20	66252905368			66252940095
9 x 1/4 x 5/8-11	6,600	10	66253006335		66252843237	66253049106
			66252844346 FC			
9 x 1/4 x 7/8	6,600	20	66253370137 FC			66253049081
Light Grinding - Type 29						
4-1/2 x 5/8-11	13,600	1		66253370009		
5 x 5/8-11	12,225	1		66253370010		
6 x 5/8-11	10,200	1		66253370011		
7 x 5/8-11	8,600	1		66253370012		
9 x 5/8-11	6,600	1		66253370013		
1/4" - Grinding - Reversible Grinding Disc						
4-1/2 x 1/4 x 5/8-11	13,600	1		66253370019		
7 x 1/4 x 5/8-11	8,600	1		66253370020		

AVAILABILITY



TIER:	BEST	BEST	BEST	BETTER	GOOD
TRADENAME:	NORTON NORZON PLUS	NORTON NORZON III	NORTON DIALAST	NORTON BLUEFIRE	NORTON FOUNDRY X
SHAPE:	Type 27	Type 27	Type 29	Type 27	Type 27
ABRASIVE:	Ceramic Alumina/ Zirconia Alumina	Ceramic Alumina/ Zirconia Alumina	Diamond	Zirconia Alumina/ Silicon Carbide	Aluminum Oxide
MATERIAL:	FOUNDRY	FOUNDRY	FOUNDRY	FOUNDRY	FOUNDRY

SIZE (D x T x H)	MAX. RPM	STD. PKG.	PART #	PART #	PART #	PART #	PART #
.140", 1/8", 1/4", - Cutting / Notching / Grinding - Type 27 and Type 29							
4 x 1/4 x 3/8	15,280	25				66252843181	
4 x 1/4 x 5/8	15,280	25				66252843180	
4-1/2 x 1/8 x 5/8-11	13,580	10				66252843206	
4-1/2 x 1/8 x 7/8	13,580	25				66252843204	
4-1/2 x 1/4 x 5/8-11	13,580	10				66252843207	
4-1/2 x 1/4 x 7/8	13,580	25				66252843205	
7 x .140 x 5/8-11	8,600	1		66253370014			
7 x 1/8 x 5/8-11	8,600	10				66252843232	
7 x 1/8 x 7/8	8,600	20				66252915526	
7 x 1/4 x 5/8-11	8,600	10				66252843231	
7 x 1/4 x 7/8	8,600	20				66252843230	
9 x .140 x 5/8-11	6,600	1		66253370015			
9 x 1/8 x 5/8-11	6,600	10				66252843240	
9 x 1/8 x 7/8	6,600	20				66252843238	
9 x 1/4 x 5/8-11	6,600	10	66253007014			66252843241	
			6,600			66252843261 HD	
9 x 1/4 x 7/8	6,600	20	66253007013	66253049069		66252843239	66252842776
			6,600			66252843260 HD	

DEPRESSED CENTER WHEEL DESCRIPTION CODES							
BLANK = ALL PURPOSE	FC = FAST CUT	HD = HEAVY DUTY	INOX/SS = CONTAMINANT FREE	LL = LONG LIFE	1-2-3 = CUTTING/NOTCHING/GRINDING		
ALUMINUM	FOUNDRY	MASONRY	STAINLESS	STEEL / METAL			



AVAILABILITY



TIER: **GOOD**
 TRADENAME: **NORTON GEMINI**
 SHAPE: Type 27
 ABRASIVE: Aluminum Oxide
 MATERIAL: ALUMINUM

SIZE (D x T x H)	MAX. RPM	STD. PKG.	GRIT	PART #
1/8", 1/4" - Cutting / Grinding / Blending - Type 27				
4-1/2 x .045 x 7/8	13,580	25	36	66252841909
4-1/2 x 1/8 x 5/8-11	13,580	10	46	66252842029
4-1/2 x 1/8 x 7/8	13,580	25	46	66252842030
4-1/2 x 1/4 x 5/8-11	13,580	10	46	66252842031
4-1/2 x 1/4 x 7/8	13,580	25	46	66252842034
5 x .045 x 7/8	12,225	25	36	66252841910
5 x 1/4 x 7/8	12,225	25	46	66252842039
6 x .045 x 7/8	10,185	25	36	66252841911
7 x 1/4 x 5/8-11	8,600	10	24	66252940514
	8,600	10	46	66252940515
7 x 1/4 x 7/8	8,600	20	24	66252940516
9 x 1/4 x 5/8-11	6,600	10	24	66253049045

AVAILABILITY



TIER: **GOOD**
 TRADENAME: **NORTON MASONRY**
 SHAPE: Type 27
 ABRASIVE: Silicon Carbide
 MATERIAL: MASONRY

SIZE (D x T x H)	MAX. RPM	STD. PKG.	PART #
1/8", 1/4" - Cutting / Grinding - Type 27			
4 x 1/8 x 5/8	15,280A	25	66252842013
4 x 1/4 x 5/8	15,280	25	66252842010
4-1/2 x 1/8 x 7/8	13,580	25	66252843601
4-1/2 x 1/4 x 5/8-11	13,580	10	66252843599
4-1/2 x 1/4 x 7/8	13,580	25	66252843600
5 x 1/4 x 7/8	12,225	25	66252843602
7 x 1/4 x 5/8-11	8,600	5	07660775942
9 x 1/4 x 5/8-11	6,600	5	07660775937

AVAILABILITY



TIER: **BETTER**
 TRADENAME: **NORTON AVOS GEMINI**
 SHAPE: Type 29
 ABRASIVE: Aluminum Oxide
 MATERIAL: ALUMINUM



TIER: **GOOD**
 TRADENAME: **NORTON GEMINI FLEXIBLE**
 SHAPE: Type 27
 ABRASIVE: Aluminum Oxide
 MATERIAL: ALUMINUM



TIER: **GOOD**
 TRADENAME: **NORTON GEMINI FLEXIBLE**
 SHAPE: Type 29
 ABRASIVE: Aluminum Oxide
 MATERIAL: ALUMINUM

SIZE (D x T x H)	MAX. RPM	STD. PKG.	GRIT	PART #	PART #	PART #
1/8", 1/4" Flexible - Blending - Type 27 and 29						
2 x 1/8 x 3/8	30,560	25	60		66252835632*	
	30,560	25	80		66252835633*	
4 x 1/8 x 5/8	15,280	20	36		66243529721#	
	15,280	20	60		66243529722#	
4-1/2 x 1/8 x 5/8-11	12,000	10	36	66252842208		66252842203
4-1/2 x 1/8 x 7/8	12,000	25	36	66252842209	66252830424#	66252842204
	12,000	25	46	66252842210		
	12,000	25	60	66252842211	66252830425#	
5 x 1/8 x 7/8	12,225	25	36	66252842212		66252842205
7 x 1/8 x 5/8-11	8,600	10	36		66252939024	66252917052
7 x 1/8 x 7/8	8,600	20	36		66252939028#	66252917051

*5 WHEELS PER DISPLAY PACK; 5 DISPLAY PACKS PER STANDARD PACKAGE.

THESE WHEELS ARE PACKED 20 PER BOX, AND MUST BE USED WITH A BACK PLATE. TWO BACK PLATES ARE INCLUDED IN EACH BOX.

DEPRESSED CENTER WHEEL DESCRIPTION CODES

BLANK = ALL PURPOSE FC = FAST CUT HD = HEAVY DUTY INOX/SS = CONTAMINANT FREE LL = LONG LIFE 1-2-3 = CUTTING/NOTCHING/GRINDING
 ■ = ALUMINUM ■ = FOUNDRY ■ = MASONRY ■ = STAINLESS ■ = STEEL / METAL



CATEGORY DEFINITION

The Norton small diameter cut-off wheel line consists of Type 01, Type 01/41 straight and Type 27/42 depressed center cut-off wheels from 1-1/2" to 9" diameters. These wheels come in ultra thin .035 for quick burn-free and burr-free cutting to .125" for more durable applications. All are reinforced for the demanding nature of portable cut-off.

- APPLICATIONS:** Cutting sheet metal, cutting pipe, and metal plate dimensioning (metal fabrication)
- SIZE RANGE:** 1-1/2" - 9" diameter
- THICKNESS RANGE:** .035, .040, .045, .060, .090, and .125
- ABRASIVE GRAIN:** Ceramic Alumina/Zirconia Alumina, Zirconia Alumina/Aluminum Oxide, Aluminum Oxide, Silicon Carbide, Diamond
- SHAPE:** Type 01, Type 01/41 Straight and Type 27/42 Depressed Center

TYPE-TO-APPLICATION RECOMMENDATION GUIDE

WHEEL TYPE/THICKNESS APPLICATIONS

TYPE 01

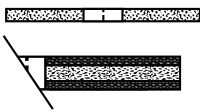

Type 01 straight cut-off wheels are designed for traditional cut-off applications. All are supplied with full fiberglass reinforcing.

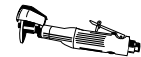

.035, .040, 1/16

Where fast cutting and low kerf loss are desired



.125

For tough cutting and notching applications where stability is important



TYPE 01/41 RIGHT CUT

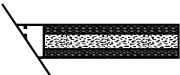

Type 01/41 straight cut-off wheels are designed for use on right angle grinder cut-off applications. All are supplied with full fiberglass reinforcing.



90° ANGLE

.035, .040, .045, .050, 1/16

Where fast cutting and low kerf loss are desired



3/32

For tough cutting and notching applications where stability is important



TYPE 27/42 RIGHT CUT



Type 27/42 cut-off wheels are designed for use on right angle grinder cut-off applications. Their depressed center shape provides a recess for the hub, which allows flush cutting. All are supplied with full fiberglass reinforcing.



90° ANGLE

.040, .045, 1/16

Where fast cutting and low kerf loss are desired



3/32, .125

For tough cutting and notching applications where stability is important



HOW TO PICK THE RIGHT BOND TYPE

All Purpose	Unmarked	Where an excellent blend of cut rate and life is needed
Free Cut	FC	Where fast stock removal is needed, or the application only allows low-pressure or under-horsepowered grinders
Long Life	LL	Where durability is needed due to severe application, and when horsepower of the grinder allows heavy pressure
Contaminate Free	INOX/SS	Contain <0.1% iron, sulfur or chlorine for rust-free and corrosion-free results; will not contaminate stainless steel
Aluminum	ALU	Specially formulated bond for reduced loading/surface contamination cutting aluminum/soft materials



MATERIAL-TO-PRODUCT RECOMMENDATION GUIDE

	BEST HIGHEST PRODUCTIVITY LOWEST TOTAL COST	BETTER EXCELLENT BLEND OF PERFORMANCE & PRICE	GOOD CONSISTENT PERFORMANCE LOW INITIAL PRICE
Cutting			
Mild Carbon / High Tensile Steel	Norton NorZon Plus	Norton BlueFire	Norton Metal
Stainless Steel / Alloys	Norton NorZon Plus	Norton BlueFire <i>INOX,SS</i>	Norton Gemini <i>INOX,SS</i>
Contaminate Free		Norton BlueFire <i>INOX,SS</i>	Norton Gemini <i>INOX,SS</i>
Cast Iron	Norton NorZon Plus	Norton BlueFire	Norton Gemini
Aluminum / Bronze / Brass			Norton Gemini <i>ALU</i>
Asphalt / Brick / Concrete			Norton Masonry

CROSS REFERENCE GUIDES

TYPE 01 .035 - .125 CUT-OFF WHEELS FOR DIE GRINDERS

NORTON	TOTAL PERFORMANCE			INITIAL PRICE		SPECIALTY	
	BEST NorZon Plus	BETTER BlueFire	GOOD Gemini <i>Free Cut</i>	Gemini	Metal	GOOD Gemini <i>INOX</i>	
Brilliant	—	Brill-Max ZA	—	—	Safe-Tex FC, LL	—	
Bullard	—	ZA46T, ZA60T	TA36T	TA46T, TA60T	A36T, A60T Comp.	—	
Camel	—	ZA60-TBF	A36 RBF	A60 RBF	Fast Cut RBF	—	
Flexovit	Flexon Fast Cut A46, 60	—	High Perf Fast Grind A36	High Perf Fast Cut A36, 46, 60	—	—	
Pearl	—	SRT, Zirconia	—	Premium	Silver Line	—	
Pferd	—	—	—	—	PSF-A	SG-A-R-INOX	
Sait	Saittech	—	A60S	A24R, A36T, A60T	—	—	
Spedecut	—	—	—	—	A46, 60 TBXX	—	
Walter	—	—	A24 ZIP	A60 ZIP	—	—	

TYPE 01/41 AND TYPE 27/42 .035 - .125 CUT-OFF WHEELS FOR RIGHT ANGLE GRINDERS

NORTON	TOTAL PERFORMANCE				INITIAL PRICE			SPECIALTY		
	BEST NorZon Plus <i>Free Cut</i>	NorZon Plus	BETTER BlueFire <i>Free Cut</i>	BlueFire	GOOD Gemini <i>Free Cut</i>	Gemini	Metal	GOOD Gemini <i>ALU</i>	Gemini <i>INOX,SS</i>	Masonry
Brilliant	—	—	—	—	Brill-Blade Extra FC	Brill-Blade Heavy Duty	Hornet Stinger	—	—	—
Bullard	—	—	—	ZA60T	SGA60U	TA46T, TA60T, TA60U	A46T, A60T Comp.	AL46N	—	C24R
Camel	—	—	—	ZA Quickie Cut	A36-S-BF	Super Quickie Cut	Quickie Cut	A46 Quickie Cut	A60-T-BF, WA60R Quickie Cut	—
Flexovit	—	—	—	—	Razorblade A60SST	Razorblade A24T, 30V, 36T	—	Razorblade A30Q	—	C30U
Metabo	—	—	—	A 60 XP Super Slicer	—	A 60 TX Slicer-Plus	A 60 TZ Slicer	—	—	—
Pearl	—	—	—	Redline Max Slimcut	—	Slimcut	Slimcut Pro-V, Sliverline	—	—	—
Pferd	—	—	—	SGP-ZA-Q-INOX	—	SG-A-S, SGP-A-T	PSF-A-P	S-G-N-ALU	SG-A-R-INOX, SGP-A-S-INOX	SG-C-R
Sait	—	Saittech	—	Z-tech	SAIT.M.X	A60S	—	A46N	XA46R	—
SpedeCut	—	—	—	—	—	—	A46, 60 TBXX	—	—	—
Walter	—	—	—	—	A-30-ZIP	A-60-ZIP	—	A-60-ZIP-ALU	A60-SS-ZIP	C-30-ZIP

FEATURED PRODUCTS



EXPANDED OFFERING

NORTON NORZON PLUS CUT-OFF / RIGHTCUT

BEST CHOICE FOR HIGHEST PRODUCTIVITY FOR STEEL, STAINLESS STEEL AND ALL FERROUS METALS

FEATURES

- Norton SG (ceramic alumina) / NorZon (zirconia alumina) grain combination
- Highly-advanced bond system
- RightCut right angle grinder wheels

BENEFITS

- Fastest cutting wheel available on the market, up to 3X faster cutting versus aluminum oxide
- 3X – 10X life versus aluminum oxide wheels on carbon steel, stainless and cast iron
- Noticeably longer life and faster cut rate
- Less pressure required for first cut



NORTON BLUEFIRE CUT-OFF / RIGHTCUT

BETTER CHOICE FOR STAINLESS STEEL, CARBON STEEL, ALLOYS AND GRAY IRON

FEATURES

- A blend of R&D advanced chemistry and shaped zirconia alumina abrasive and premium aluminum oxide grain
- RightCut right angle grinder wheels

BENEFITS

- 2-3 times the life of aluminum oxide wheels
- Broad utility from light-to heavy-pressure applications
- Excellent performance-to-price ratio for lower total grinding costs
- Noticeably longer life and faster cut rate
- Less pressure required for first cut



IMPROVED

NORTON GEMINI CUT-OFF / RIGHTCUT

GOOD, VERSATILE CHOICE FOR STEEL AND FERROUS METALS

FEATURES

- Quality, versatile aluminum oxide
- Gemini Contaminate-Free **INOX/SS**
- .045 ultra-thin Gemini RightCut right angle grinder Type 01/41 straight and T27/42 depressed center cut-off wheels

BENEFITS

- Consistent performance at a competitive price
- Contain <0.1% iron, sulfur or chlorine for rust-free and corrosion-free results; will not contaminate stainless steel
- Precise cutting; more stability and a narrower pass
- Up to 70% longer life and 20% faster cut rate than standard aluminum oxide wheels – for substantial savings
- Require less pressure, providing increased operator comfort



NORTON METAL CUT-OFF / RIGHTCUT

GOOD CHOICE FOR GRINDING ALLOYS, METALS, STEELS, AND FERROUS METALS

FEATURES

- Quality aluminum oxide
- Low initial cost per wheel

BENEFITS

- Consistent performance at a competitive price
- Ideal for on-site and small-unit jobs

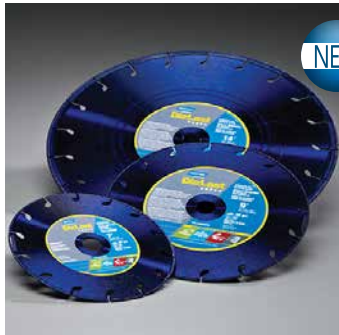

NEW

NORTON DIALAST DIAMOND CUT-OFF

BEST FOR PIPE, TUBING, CAST IRON, CARBON AND MILD STEEL AND CERAMIC APPLICATIONS

FEATURES

- A combination of high-quality diamond and advanced brazed single-layer bonding technology
- Environmentally friendly grinding

BENEFITS

- Extra-long life vs. conventional abrasives or other vacuum-brazed diamond tools
- Retains the diamond grains and wheel shape for full life with low spark, while keeping a continuous grinding depth
- Less blade changes reduce downtime and labor costs
- Generate minimal dust



AVAILABILITY

TIER:	BEST	BETTER	BETTER	GOOD	GOOD	GOOD
TRADENAME:	NORTON NORZON PLUS	NORTON BLUEFIRE	NORTON A60-0BNA2	NORTON GEMINI	NORTON GEMINI LONG LIFE	NORTON METAL
SHAPE:	Type 01	Type 01	Type 01	Type 01	Type 01	Type 01
ABRASIVE:	Ceramic Alumina/ Zirconia Alumina	Zirconia Alumina/ Aluminum Oxide	Aluminum Oxide	Aluminum Oxide	Aluminum Oxide	Aluminum Oxide
MATERIAL:	STAINLESS STEEL/METAL	STAINLESS STEEL/METAL	STAINLESS STEEL/METAL	STAINLESS STEEL/METAL	STAINLESS STEEL/METAL	STAINLESS STEEL/METAL

SIZE (D x T x H)	MAX. RPM	STD. PKG.	PART #	PART #	PART #	PART #	PART #	PART #	
.035", .040", .060", 1/16" and .125" Type 01 - Cut-off									
1-1/2 x .035 x 1/16	40,745	25			66243427764				
1-1/2 x .035 x 1/8	40,745	25			66243427831				
1-1/2 x .035 x 1/4	40,745	25			66243427875				
2 x .035 x 1/8	30,560	25				66243411392	FC		
2 x .035 x 1/4	30,560	25			66243428014	66243411393	FC		
2 x .035 x 3/8	30,560	25				66243411394	FC		
2 x .060 x 1/8	30,560	25			66243428041				
2 x 1/16 x 1/4	30,560	25			66243427993	66243411395	FC		
2 x 1/16 x 3/8	30,560	25				66243411396	FC		
2 x .125 x 1/4	30,560	25				66243411402	FC		
2 x .125 x 3/8	30,560	25				66243411403	FC		
2-1/2 x .035 x 1/8	30,560	25			66243528476				
2-1/2 x .035 x 1/4	30,560	25			66243528425				
2-1/2 x 1/16 x 1/4	30,560	25				66243510640	FC		
2-1/2 x 1/16 x 3/8	30,560	25				66243510641	FC		
3 x .035 x 1/4	25,465	25	66243510668		66243528573	66243510627	FC		
	25,465	25*	66243531753	<i>5-Pk</i>					
3 x .035 x 3/8	25,465	25	66243510669	66252843174	66243528574	66243510628	FC	66243537271	LL
	25,465	25*	66243534828	<i>5-Pk</i>	66243534821	<i>5-Pk</i>			
3 x 1/16 x 1/4	25,465	25	66243510670		66243528471	66243510645	FC	66243510649	LL
3 x 1/16 x 3/8	25,465	25	66243510671	66252843175	66243528552	66243510647	FC	66243510648	LL
	25,465	25	66243510835	LL					
	25,465	25*							07660747767
	25,465	100							07660789012
	25,465	1							66252843624
									<i>5-Pk with Mandrel</i>
3 x .125 x 1/4	25,465	25				66243510650	FC	66243510652	LL
3 x .125 x 3/8	25,465	25	66243510673			66243510651	FC	66243510653	LL
4 x .035 x 1/4	15,300	25			66243529606				07660789384
	19,100	25				66243510629	FC		
4 x .035 x 3/8	19,100	25	66243510675	66252843173	66243529621	66243510630	FC	66243537273	LL
	19,100	250							07660789453
4 x .035 x 1/2	19,100	25			66243529622				66252836496
4 x .035 x 3/4	19,100	25			66243529609				<i>250-Pk</i>
4 x .040 x 3/8	19,100	25			66243529516				
4 x 1/16 x 1/4	19,100	25	66243510676			66243510654	FC		
4 x 1/16 x 3/8	19,100	25	66243510677	66252843171		66243510655	FC	66243510657	LL
4 x 1/16 x 5/8	19,100	100			66243527827				66252843848
	19,100	100			FabTech				
					66243527826				
					FabTech	LL			
4 x .125 x 1/4	19,100	25				66243510658	FC		
4 x .125 x 3/8	19,100	25	66243510841	66252843172		66243510659	FC	66243510661	LL
	19,100	25	66243510680	LL					
5 x .035 x 3/8	12,225	25			66252830653				
6 x .035 x 3/8	10,185	25			66252835064				
6 x .035 x 1/2	10,185	25			66252835053				
6 x .035 x 5/8	10,185	25			66252835054	66252809714			
Drill Mount Mandrel		5							07660747769+

+ FOR MOUNTING 2" AND 3" X 3/8" HOLE CUT-OFF WHEELS ON TO A DRILL
 * 5-WHEEL JOB PACKS; WHEELS ARE PACKED 5 WHEELS/PACK, WITH 5 JOB PACKS/CARTON. ORDER PER EACH WHEEL IN STANDARD PACKAGE QUANTITIES OF 25. ORDER IN MULTIPLES OF 25.
 • BULK PACKED 250/CARTON; 5 INNER BOXES OF 50 WHEELS EACH. ORDER IN MULTIPLES OF 250 WHEELS.

WHEEL DESCRIPTION CODES			
BLANK = ALL PURPOSE	FC = FREE CUT	INOX/SS = CONTAMINANT FREE	LL = LONG LIFE
■ = MASONRY	■ = STAINLESS	■ = STEEL / METAL	



AVAILABILITY



TIER:



TRADENAME:

NORTON NORZON PLUS RIGHTCUT	NORTON DIALAST RIGHTCUT	NORTON BLUEFIRE RIGHTCUT	NORTON GEMINI RIGHTCUT	NORTON METAL RIGHTCUT
------------------------------------	--------------------------------	---------------------------------	-------------------------------	------------------------------

SHAPE:

Type 01/41	Type 01/41	Type 01/41	Type 01/41	Type 01/41
------------	------------	------------	------------	------------

ABRASIVE:

Ceramic Alumina/ Zirconia Alumina	Diamond	Zirconia Alumina/ Aluminum Oxide	Aluminum Oxide	Aluminum Oxide
--------------------------------------	---------	-------------------------------------	----------------	----------------

MATERIAL:

STAINLESS	STAINLESS	STAINLESS	STAINLESS	STAINLESS
STEEL/METAL	STEEL/METAL	STEEL/METAL	STEEL/METAL	STEEL/METAL

SIZE (D x T x H)	MAX. RPM	STD. PKG.	PART #	PART #	PART #	PART #	PART #
.035", .040", .045", .050", 1/16, and 3/32" Type 01/41 – RightCut Cut-off							
4 x .040 x 5/8	15,280	25					07660701616
4 x .045 x 5/8	15,280	25				66243527956	
4 x 3/32 x 5/8	15,280	25				66243527955	
4-1/2 x .035 x 7/8	13,580	25					66252843846
4-1/2 x .040 x 7/8	13,580	25			66252843225		07660701617
	13,580	50					66253370222
	13,580	250•					66252840001 250-Pk
	13,580	25*					66252842158 5-Pk
4-1/2 x .045 x 7/8	13,580	25	66252830730		66252843208	66252823602	
	13,580	25				66252841994 ALU	
	13,580	25				66252841997 INOX/SS	
	13,580	250•				66252841213 250-Pk	
	13,580	25*			66252842159 5-Pk	66252842160 5-Pk	
4-1/2 x .050 x 7/8	13,580	1		66253370016			
4-1/2 x 1/16 x 7/8	13,580	25					66252843845
4-1/2 x 3/32 x 7/8	13,580	25				66252823599	
5 x .040 x 5/8	12,225	25					66252843847
5 x .040 x 7/8	12,225	25			66252843226		07660701618
	12,225	25*					66252842168 5-Pk
5 x .045 x 7/8	12,225	25	66252830731		66252843209	66252823603	
	12,225	25				66252841995 ALU	
	12,225	25				66252841998 INOX/SS	
	12,225	250•				66252841214 250-Pk	
	12,225	25*			66252842169 5-Pk	66252842170 5-Pk	
5 x .050 x 7/8	12,225	25	66252809829				
	12,225	1		66253370017			
5 x 3/32 x 7/8	12,225	25				66252823600	
6 x .040 x 7/8	10,185	25					07660702757
	10,185	50					66253370223
	10,185	250•					66252841212 250-Pk
	10,185	25*					66252842173 5-Pk
6 x .045 x 7/8	10,185	25	66252842008		66252843210	66252823604	
	10,185	25				66252841996 ALU	
	10,185	25				66252841999 INOX/SS	
	10,185	250•				66252841215 250-Pk	
	10,185	25*			66252842174 5-Pk	66252842175 5-Pk	
6 x .050 x 7/8	10,185	1		66253370018			
6 x 3/32 x 7/8	10,185	25				66252823601	
7 x .045 x 7/8	8,600	25				66252832323	
	8,600	20				66252842000 INOX	
	8,600	25				66252905957	
7 x 1/16 x 5/8	8,600	25					
7 x 1/16 x 7/8	8,600	25	66252900652				07660704732
	8,600	1		70184694055			
9 x .060 x 7/8	6,600	1		70184694056			

RIGHTCUT WHEELS ARE TO BE USED FOR CUTTING ONLY
 * 5-WHEEL JOB PACKS; WHEELS ARE PACKED 5 WHEELS/PACK, WITH 5 JOB PACKS/CARTON. ORDER PER EACH WHEEL IN STANDARD PACKAGE QUANTITIES OF 25. ORDER IN MULTIPLES OF 25.
 • BULK PACKED 250 WHEELS/CARTON; 5 INNER BOXES OF 50 WHEELS EACH. ORDER IN MULTIPLES OF 250 WHEELS.



Gemini RightCut Right Angle Grinder Cut-off Wheels

THINNER! FASTER! STRONGER! Our 100% aluminum oxide abrasive has been infused with a new bond technology and processed to outlast and out-cut competitive aluminum oxide blades. Operators will notice and appreciate the low kerf loss and added comfort.

Available in Type 01/41 straight and Type 27/42 depressed center wheels.

We Make the Right Choice More Comfortable



AVAILABILITY



TIER:	BEST	BETTER	GOOD	GOOD
TRADENAME:	NORTON NORZON PLUS	NORTON BLUEFIRE	NORTON GEMINI	NORTON METAL
SHAPE:	Type 27/42	Type 27/42	Type 27/42	Type 27/42
ABRASIVE:	Ceramic Alumina/ Zirconia Alumina	Zirconia Alumina/ Aluminum Oxide	Aluminum Oxide	Aluminum Oxide
MATERIAL:	STAINLESS STEEL/METAL	STAINLESS STEEL/METAL	STAINLESS STEEL/METAL	STAINLESS STEEL/METAL

SIZE (D x T x H)	MAX. RPM	STD. PKG.	PART #	PART #	PART #	PART #
.040, .045, 1/16", - RightCut Cut-off - Type 27/42						
4 x .045 x 5/8	15,280	25			66252842180	07660705249
4-1/2 x .040 x 5/8-11	13,580	10		66252843227		
4-1/2 x .045 x 5/8-11	13,580	10	66252842006	66252843223	66252842025	
	13,580	10			66252841913 INOX/SS	
4-1/2 x .045 x 7/8	13,580	25	66252843320	66252843219	66252842026	66252843604
	13,580	25			66252841912 INOX/SS	
	13,580	25*			66252842161 5-Pk	
	13,580	250			66253370065 250-Pk	
5 x .040 x 5/8-11	12,225	10		66252843228	66252841939	
5 x .045 x 5/8-11	12,225	10			66252841915 INOX/SS	
	12,225	10			66252842036	66252843849
5 x .045 x 7/8	12,225	25	66252843329	66252843220	66252841914 INOX/SS	
	12,225	25			66252842171 5-Pk	
	12,225	25*			66253370066 250-Pk	
	12,225	250			66252830587	
6 x .045 x 5/8-11	10,185	10	66252842007		66252841917 INOX/SS	
	10,185	10			66252842202	66252842015
6 x .045 x 7/8	10,185	25	66252842009	66252843221	66252841916 INOX/SS	
	10,185	25			66252842176 5-Pk	
	10,185	25*			66253370067 250-Pk	
	10,185	250			66252841919 INOX/SS	
7 x .045 x 5/8-11	8,600	10			66252912626	
7 x .045 x 7/8	8,600	20			66252841918 INOX/SS	
	8,600	20				07660705251
7 x 1/16 x 7/8	8,600	10				
9 x 1/16 x 5/8-11	6,600	10			66253019115	

RIGHTCUT WHEELS ARE TO BE USED FOR CUTTING ONLY.

3/32", .125" - Cut-off - Type 27/42						
4 x .125 x 3/8	15,280	25	66252842001			
4-1/2 x 3/32 x 5/8-11	13,580	10			66252841903	
	13,580	10			66252842027 INOX/SS	
4-1/2 x 3/32 x 7/8	13,580	25			66252841940	
	13,580	25			66252842028 INOX/SS	
	13,580	25			66252843582 1-2-3	
4-1/2 x .125 x 5/8-11	13,580	10	66252843321		66252843588	
4-1/2 x .125 x 7/8	13,580	25	66252843322		66252843589	
5 x 3/32 x 5/8-11	12,225	10			66252841904	
5 x 3/32 x 7/8	12,225	25			66252842037 INOX/SS	
	12,225	25			66252843587 LL	
	12,225	25			66252843583 1-2-3	
5 x .125 x 7/8	12,225	25			66252843595	
6 x 3/32 x 5/8-11	10,185	10			66252841905	
6 x 3/32 x 7/8	10,185	25			66252841906	
	10,185	25			66252832487 INOX/SS	
6 x .125 x 5/8-11	10,185	10			66252841192	
6 x .125 x 7/8	10,185	25			66252842021	
7 x 3/32 x 5/8-11	8,600	10			66252841907	
7 x 3/32 x 7/8	8,600	20			66252841908	
	8,600	20			66252914638 INOX/SS	
7 x .125 x 5/8-11	8,600	10	66252912625			
7 x .125 x 7/8	8,600	20	66252912624		66252900619	
9 x 3/32 x 5/8-11	6,600	10		66252842378		
9 x 3/32 x 7/8	6,600	20		66252842343		

THESE WHEELS ARE TO BE USED FOR CUTTING ONLY.

* 5-WHEEL JOB PACKS; WHEELS ARE PACKED 5 WHEELS/PACK, WITH 5 JOB PACKS/CARTON. ORDER PER EACH WHEEL IN STANDARD PACKAGE QUANTITIES OF 25. ORDER IN MULTIPLES OF 25.

See .045" RightCut Wheels for Aluminum on page 17.

WHEEL DESCRIPTION CODES			
BLANK = ALL PURPOSE	FC = FREE CUT	INOX/SS = CONTAMINANT FREE	LL = LONG LIFE
■ = MASONRY	■ = STAINLESS	■ = STEEL / METAL	

AVAILABILITY

TIER:	 BEST	 BETTER	 GOOD	 GOOD	 GOOD
TRADENAME:	NORTON DIALAST	NORTON CHARGER	NORTON GEMINI	NORTON METAL	NORTON MASONRY
SHAPE:	Type 01	Type 01	Type 01	Type 01	Type 01
ABRASIVE:	Diamond	Zirconia Alumina/ Aluminum Oxide	Aluminum Oxide	Aluminum Oxide	Silicon Carbide
MATERIAL:	STAINLESS	STEEL/METAL	STEEL/METAL	STEEL/METAL	MASONRY

SIZE (D x T x H)	MAX. RPM	STD. PKG.	PART #	PART #	PART #	PART #	PART #
Type 01 – Circular Saw							
6 x .035 x 5/8	10,185	25			66252809714		
6 x .060 x 5/8	10,185	25			66252809718		
6-1/2 x .125 x DM-5/8	9,405	10				07660789098	07660789089
7 x .060 x 5/8	8,730	25			66252905957		
7 x .060 x 7/8	8,730	1	70184694055				
7 x .125 x DM-5/8	8,730	25				07660789097	07660789088
8 x 1/16 x 5/8	7,640	25		66253017771 LL	66253007025		
	7,640	10			66253017795		
8 x 1/8 x DM-5/8	7,640	10				07660789096	07660789086
9 x .060 x 7/8	6,600	1	70184694056				

DM DENOTES DIAMOND MOUNT; 5/8" HOLE BUSHINGS INCLUDED

WHEEL DESCRIPTION CODES

BLANK = ALL PURPOSE	FC = FREE CUT	INOX/SS = CONTAMINANT FREE	LL = LONG LIFE
= MASONRY	= STAINLESS	= STEEL / METAL	

Dialast Diamond: Introducing The Last Cut-Off and Depressed Center Wheels Standing!



Metal working demands tools that will cut or grind fast, throw a minimum of spark, and above all, LAST.

These new Norton DiaLast diamond cutting and grinding wheels give the operator everything needed to get the job done right, the very first time:

- Right angle grinder, circular saw, and chop saw blades for cutting steel, metal studs, stainless steel, nonferrous materials, tile, brick, plastic, and much more.
- DiaLast depressed center cutting and grinding wheels are an excellent choice on steel, cast iron, ductile pipe, tubing, and metal plate when high stock removal is desired

To learn more, see DiaLast depressed center (page 12) and cut-off wheel Features and Benefits (page 20).



CATEGORY DEFINITION

Norton high-speed cut-off abrasive wheels provide the industry's leading performance in all high-speed gas and electric-powered applications.

- APPLICATIONS:**
 - Metalworking: steel, stainless, ductile, cast iron, rail steel and metal decking
 - Non-Metal Building Materials: concrete, brick, masonry, asphalt aggregate, stone and schedule 40 and 80 PVC pipe
 - Rescue and Demolition: steel, acrylic, fiberglass, rubber, glass, wood, concrete, brick and asphalt
- SIZE RANGE:** 12" – 16" diameter
- THICKNESS RANGE:** 1/8"
- ABRASIVE GRAIN:** Aluminum Oxide, Silicon Carbide, Silicon Carbide/Aluminum Oxide Blend
- SHAPE:** Type O1 Straight
- REINFORCEMENT:** Wheels are offered in standard two layer reinforcement as well as three layer reinforcement for higher-speed saws and heavy-duty applications
- ARBOR:** Wheels are offered with patented universal arbor that accommodates both 20mm and all other machines with 1" arbors

MATERIAL / APPLICATION-TO-PRODUCT RECOMMENDATION GUIDE

ICON		APPLICATION
	Metal	High-performance aluminum oxide grain wheels designed for general purpose cutting of all steel and stainless parts including rebar, steel pipe, structural steel, sheet metal, cable and small to medium diameter solid pieces.
	Metal Decking	High-performance aluminum oxide abrasive combined with a thicker wheel that stands up to the sharp edges of sheet metal and roof decking.
	Rail Steel	A finer grit, harder grade aluminum oxide wheel designed for straight, fast cuts on all sizes of rail track. Additional high-performance lines of rail cut wheels are available for production applications.
	Ductile/Cast Iron	A special blend of silicon carbide abrasive for cutting and aluminum oxide abrasive for life, designed to cut ductile and cast iron pipe, concrete-lined water pipes, sewer construction and heavy duty PVC.
	Rescue	For ventilation, forcible entry, rescue and demolition. A versatile abrasive formula that can be used on a wide range of materials including all types of metals and masonry.
	Concrete	Coarse grit silicon carbide abrasive provides a low initial cost solution for cutting brick, block, concrete or other masonry materials. For higher-production applications that require optimum speed of cut and product life, please see our complete selection of high-speed diamond wheels in our Norton Construction diamond product line.
	Asphalt	A special blend of extra coarse silicon carbide abrasive grains provides a low initial cost solution for cutting asphalt, green concrete, asphalt over concrete, a wide range of aggregates and abrasive materials. For higher-production applications that require optimum speed of cut and product life, please see our Norton Construction diamond product line.

HOW TO PICK THE RIGHT REINFORCEMENT



Two full layers of reinforcing are offered for lower power machines, and light to medium applications where speed of cut is the primary selection criterion.



Three full layers of reinforcing are recommended for high speed, high horsepower machines where the application is heavy-duty, and durability is the primary selection criterion.

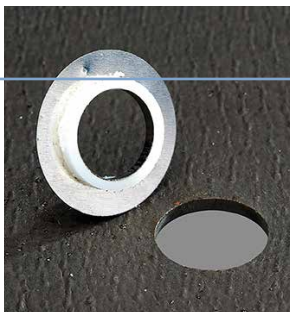

Universal Arbor

Two Blade Sizes in One

Our Norton patented 1"/20mm knock-out arbor fits all gas and electric high-speed saws. A 20mm bushing is pre-mounted into the 1" molded arbor hole. The wheel, with the 20mm bushing, can be mounted directly on any 20mm arbor high-speed saw. With the bushing removed, exposing the 1" arbor hole, the wheel can be mounted on any 1" arbor high-speed saw. Combining this arbor, with heavy-duty triple reinforcing results in a higher performing, extra strong, longer lasting cutting wheel. Once the 20mm bushing is removed, it cannot be replaced.











CROSS REFERENCE GUIDE

SPECIALTY

NORTON











	GOOD Gemini Metal	Gemini Metal Decking	Rail Steel	Gemini Ductile	Gemini Concrete	Gemini Asphalt
Abmast	A 24 R, Kompetitor Metal	A 24 T	Rail-Kut A 24 Z	AC 24 R, Kompetitor Ductile Iron	C 24 R, Kompetitor Concrete	C 16 T, Kompetitor Asphalt
Brilliant	Metal/Stainless	—	A24PB	—	Concrete/Masonry	—
Bullard Blaze & Road Warrior	A24R, ZA24Q, The Competitor	TA24R	A30R	AC24R	C24R, The Competitor	CC20R
Camel	A24-R	A24-T	—	AC24-R	C24-R	C16-U
Flexovit	A24/30SB	A24TB	A30PB	AC24SB	C30UB	C16UB
Husqvarna	Blue XHS, Blue QMS-CM, Blue EHS	Grey QMS-CM	Yellow QMS-CM	Green QMS-CM, Green EHS	Red XHS, Red QHS-CM, Red EHS	Black QMS-AS
Pearl	SRT, Premium A36S, Silver Line A30R	—	—	AC30S	Premium C36S, Silver Line C24R	—
Pferd	A 24 R SG	A 24 Q SG-RAIL	A 24 Q SG-RAIL	AC 24 Q SG	C 24 R SG	—
Sait	A24R, A30S, XFC	Brute	Hobo	Ductile	C24R	Big M.A.C, XFC
Tyrolit	A30P, A30BF	—	—	AC24, AC30BF	1C24, C30BF	—
Virginia Abrasives	Metal	—	—	Ductile	Concrete	Asphalt
Walter	A-24	—	—	—	—	—

AVAILABILITY

					
TIER:	GOOD	GOOD	GOOD	GOOD	GOOD
BRAND:	Norton	Norton	Norton	Norton	Norton
TRADENAME:	GEMINI METAL HD	GEMINI METAL	GEMINI METAL DECKING	RAIL STEEL	GEMINI RESCUE
SHAPE:	Type 01	Type 01	Type 01	Type 01	Type 01
ABRASIVE:	Aluminum Oxide	Aluminum Oxide	Aluminum Oxide	Aluminum Oxide	Aluminum Oxide
REINFORCING:	3 Layers	2 Layers	2 Layers	2 Layers	2 Layers
MATERIAL:					

SIZE (D x T x H)	MAX. RPM	STD. PKG.	PART #	PART #	PART #	PART #	PART #
Type 01 Cut-off – for Gas & Electric-Powered Saws							
12 x 1/8 x 1" / 20mm	6,300	10	66252836708	66252837838			
14 x 1/8 x 1" / 20mm	5,400	10	66252835386	66252837841			66243578262
14 x 1/8 x 1"	5,400	10				66253260462	
14 x 5/32 x 1" / 20mm	5,400	10			66252832521		
16 x 1/8 x 1" / 20mm	4,800	10		66252830886			
16 x 1/8 x 1"	4,800	10				66253259935	

AVAILABILITY

					
TIER:	GOOD	GOOD	GOOD	GOOD	GOOD
BRAND:	Norton	Norton	Norton	Norton	Norton
TRADENAME:	GEMINI DUCTILE HD	GEMINI DUCTILE	GEMINI CONCRETE HD	GEMINI CONCRETE	GEMINI ASPHALT
SHAPE:	Type 01	Type 01	Type 01	Type 01	Type 01
ABRASIVE:	Silicon Carbide / Aluminum Oxide Blend	Silicon Carbide / Aluminum Oxide Blend	Silicon Carbide	Silicon Carbide	Silicon Carbide
REINFORCING:	3 Layers	2 Layers	3 Layers	2 Layers	2 Layers
MATERIAL:					

SIZE (D x T x H)	MAX. RPM	STD. PKG.	PART #	PART #	PART #	PART #	PART #
Type 01 Cut-off – for Gas & Electric-Powered Saws							
12 x 1/8 x 1" / 20mm	6,300	10		66252837840	66252836709	66252837839	70184670243
14 x 1/8 x 1" / 20mm	5,400	10	66252835388	66252837843	66252835387	66252837842	70184672877
16 x 1/8 x 1" / 20mm	4,800	10				70184623029	



CATEGORY DEFINITION

The Norton RailCut line is designed for high-speed fixtured hydraulic or gas-powered rail saws.

- APPLICATIONS:** Fixed rail track cutting
- SIZE RANGE:** 14" and 16" diameter
- THICKNESS RANGE:** 1/8"
- GRIT RANGE:** 24 – 36
- ABRASIVE GRAIN:** Zirconia Alumina/Aluminum Oxide Blend, Zirconia Alumina, and Aluminum Oxide
- SHAPE:** Type 01 Straight
- REINFORCEMENT:** Side reinforced with R (rough) sides
- SPEED RATING:** All wheels are rated for 20,000 SFPM applications

CROSS REFERENCE GUIDE AND MACHINE-TO-PRODUCT RECOMMENDATION GUIDE

NORTON	BEST RailCut X	BETTER NorZon III RailCut	GOOD A30X		BEST HIGHEST PRODUCTIVITY LOWEST TOTAL COST	BETTER EXCELLENT BLEND OF PERFORMANCE & PRICE	GOOD CONSISTENT PERFORMANCE LOW INITIAL PRICE
Bullard Abrasive	Trackmaster Pro ZA24 Q-BF (Blue)	Trackmaster Pro ZA24 Q-BF (Blue)	Trackmaster A30 R-BF (Red)	Hydraulic Saw	RailCut X		A30X
Flexovit USA	-		A30-PB	Gas Saw			
Giesmar	AM303-R	AM303-R	NR242-Q	High-Horsepower / Newer Machine	RailCut X	NorZon III RailCut	A30X
Klingspor	A 24 SX Special	A 24 SX Special	-	Low-Horsepower / Older Machine	RailCut X	NorZon III FastCut	A30X
Portaco	A30 R-BF	A30 R-BF	-				
Racine Kwik Kut	A24R	A24R	-				

FEATURED PRODUCTS



NORTON RAILCUT X

BEST CHOICE FOR HIGH PERFORMANCE CUTTING OF RAILS ON APPLICATIONS WHERE THE HYDRAULIC OR GAS SAW IS FIXTURED AND HAS ADEQUATE POWER

FEATURES

- NEW! High-performance zirconia alumina/engineered aluminum oxide blend; R (rough) sides

BENEFITS

- Expertly cuts a broad range of materials
- Longest lasting and fastest cutting wheels

AVAILABILITY



TIER:
TRADENAME:

ABRASIVE:

SIZE (D x T x H)	MAX. RPM	STD. PKG.	BEST NORTON RAILCUT X	BETTER NORTON NORZON III RAILCUT	BETTER NORTON NORZON III RAIL FASTCUT	GOOD NORTON A30X RAILCUT
			Zirconia Alumina/ Aluminum Oxide Blend	Zirconia Alumina	Zirconia Alumina	Aluminum Oxide
			PART #	PART #	PART #	PART #
Type 01 Cut-off						
14 x 1/8 x 1	5,400	10	66253337716	66253360493	66253363694	66253260462
16 x 1/8 x 1	4,800	10	66253335024	66253464607	66253464415	66253259935



CATEGORY DEFINITION

These powerful, self-propelled machines are designed to cut concrete slabs and asphalt and are normally fitted with diamond blades. For inexperienced operators or small jobs, the machines can accommodate these low initial cost, conventional abrasives wheels.

APPLICATIONS:	Cutting straight sections of concrete surfaces
SIZE RANGE:	14" and 18" diameter
THICKNESS RANGE:	3/16" – 3/8"
ABRASIVE GRAIN:	Silicon Carbide
BOND:	Hot Pressed (HP) – for higher-horsepower machine applications where additional durability is needed, may be used wet or dry Cold Pressed (CP) – for lower-horsepower machines, which need a free-cutting wheel
SHAPE:	Type 01 Straight
ARBOR:	All are 1" with a drive pin



CROSS REFERENCE GUIDE

NORTON

- Abmast**
- Bullard Blaze & Road Warrior**
- Camel**
- Flexovit**
- Husqvarna**
- Pearl**
- Pferd**
- Sait**
- Tyrolit**
- Virginia Abrasives**
- Walter**

	←	SPECIALTY	→
	BETTER Gemini <i>Asphalt / Green Concrete – HP</i>	GOOD Gemini <i>Asphalt - CP</i>	GOOD Gemini <i>Concrete - CP</i>
Abmast	—	C 16 T. Kompetitor Asphalt/Concrete	C 24 R
Bullard Blaze & Road Warrior	—	C16R & T, C16R3	—
Camel	—	C16-U	C24-R
Flexovit	HPC16AG	C16 G.P. C16UB	C20SB/C16TB
Husqvarna	Red GC-7A	Black EWC	Gold RTC, Blue RTC, Blue EWC
Pearl	—	—	Premium C36S, Silver Line C24R
Pferd	—	C 24 R SG ASP	C 24 R SG GP
Sait	Street Runner	C16	C24R, Street Walker
Tyrolit	Concrete/Asphalt CHP	Asphalt CP	Concrete CP
Virginia Abrasives	—	GC/Asphalt	Concrete
Walter	—	—	C-24

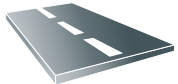
AVAILABILITY

	BETTER	GOOD	GOOD
TIER:			
BRAND:	Norton	Norton	Norton
TRADENAME:	GEMINI ASPHALT - HP	GEMINI ASPHALT - CP	GEMINI CONCRETE - CP
SHAPE:	Type 01	Type 01	Type 01
ABRASIVE:	Silicon Carbide	Silicon Carbide	Silicon Carbide
BOND:	Hot Pressed	Cold Pressed	Cold Pressed
MATERIAL:			

SIZE (D x T x H)	MAX. RPM	STD. PKG.	PART #	PART #	PART #
Type 01 Cut-off – For Walk-Behind Saws					
14 x 3/16 x 1 Pin Hole	4,365	10	70184670100	70184680324	70184680323
14 x 1/4 x 1 Pin Hole	4,365	5	70184670099	70184670535	70184670533
18 x 1/4 x 1 Pin Hole	4,250	5	70184670103	70184670098	
18 x 3/8 x 1 Pin Hole	4,250	5	70184648998		

For higher-production applications, optimum speed of cut and product life, please see our complete selection of walk-behind diamond blades in our Diamond, Abrasives and Equipment for the Construction Market Catalog #7719 found on www.nortonconstructionproducts.com.



CATEGORY DEFINITION

A chop saw is a light, low-horsepower portable machine. Although very similar to a compound miter saw, it is designed for cutting denser materials, like metal bar, tubing or pipe. Chop saw cut-off wheels are designed specifically for this machine with finer grit, softer grades, and reinforcement layers that match the application.

APPLICATIONS:	Cutting small-diameter metal pieces, bar stock, metal pipe, tubing, decking, cable, drywall studs, and metal plate dimensioning
SIZE RANGE:	10" - 16" diameter
THICKNESS RANGE:	7/64"
ABRASIVE GRAIN:	Zirconia Alumina/Aluminum Oxide Blend, Aluminum Oxide, Silicon Carbide
SHAPE:	Type O1 Straight
REINFORCEMENT TYPE:	Side reinforced, centrally reinforced

CROSS REFERENCE GUIDE

	TOTAL PERFORMANCE ←			INITIAL PRICE →			SPECIALTY →		
NORTON	BETTER BlueFire Free Cut	BlueFire Rapid Cut	BlueFire Long Life	GOOD Gemini Free Cut	Gemini Rapid Cut	Gemini Long Life	GOOD Stud Cutter	Gemini Aluminum	Masonry
Brilliant	—	—	—	Super-G	Tube/Pipe	—	Drywall Stud	Aluminum	—
Bullard	ZA36T	—	—	TA36T A46T The Competitor	A36R The Competitor	A36R Ironmaster	A46T Studmaster	AL36R	—
Camel	—	—	ZA24-S	A36-P, WA36-P	—	A36-S	A30-R Mr. Stud	A30-N	—
Dewalt	—	—	XP	GP, Stainless Fabrication	—	—	Stud Cutting	—	—
Flexovit	—	—	—	A30R Fast Cut A30-Q Free Cut	—	A30S Long Life	A30T Drywall Stud	—	—
Makita	—	—	—	—	General Purpose	—	—	—	—
Pearl	SRT36	—	—	A36P Premium	A30P Silver Line	—	A46S Stud Cutting	—	—
Pferd	—	—	—	A 36 K SG CHOP	PSF CHOP	—	A 36 K SG-STUD	—	C 36 K SG-CHOP
Sait	Saitech Steel Worker	Z-tech	—	EZ-Chop	EZ-Chop Attacker	Iron Worker	Stud King	Aluminum	—
Walter	—	—	—	—	A-30	A-30-HC+	—	A30-ALU	—

APPLICATION-TO-PRODUCT RECOMMENDATION GUIDE

WHEEL TYPE/REINFORCEMENT

TYPE O1 STRAIGHT SIDE REINFORCED CUT-OFF WHEEL

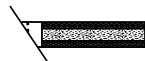

Side reinforced wheels have two full layers of reinforcing and are designed for a fast cut and the most aggressive applications. All Purpose, Free Cut, and Long Life are side reinforced.

TYPE O1 STRAIGHT CENTRALLY REINFORCED CUT-OFF WHEEL

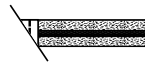

Centrally reinforced wheels have a single layer of reinforcing with exposed rough sides for free-cutting, non-binding applications where minimal burr and burn are the key requirements. Rapid Cut wheels are centrally reinforced.

HOW TO PICK THE RIGHT BOND TYPE

All Purpose	Unmarked	Where an excellent blend of cut rate and life is needed
Free Cut	FC	Used when fast, burn-free cutting is desired or when cutting pieces with larger cross sections
Long Life	LL	Where durability is needed due to severe application, and when cutting parts with small cross sections
Rapid Cut	RC	Where a free cutting, non-binding wheel is needed for burn-free and burr-free cuts
High-Performance	STUD	High-performance aluminum oxide/resin bond combination designed for cleaner cuts and longer life when cutting steel studs
Aluminum	ALU	Specially formulated bond for reduced loading/surface contamination when cutting aluminum/soft materials



FEATURED PRODUCTS



NORTON BLUEFIRE CHOP SAW REINFORCED CUT-OFF WHEELS

BETTER CHOICE FOR STEEL, STAINLESS STEEL AND ALL OTHER FERROUS METALS

FEATURES

- Durable zirconia alumina / premium aluminum oxide abrasive blend
- Free Cut: side reinforced
- Long Life: side reinforced
- Rapid Cut: centrally reinforced, rough sides

BENEFITS

- 2X the life and cut rate of aluminum oxide
- Engineered for larger cross-sections and/or hard-to-cut materials
- Ideal for small cross-section workpieces
- Free cutting, non-binding; burr- and burn-free cuts



NORTON GEMINI CHOP SAW REINFORCED CUT-OFF WHEELS

GOOD CHOICE FOR ALL STEEL AND FERROUS METALS AS WELL AS SPECIALTY APPLICATIONS IN ALUMINUM

FEATURES

- Free Cut: side reinforced
- Long Life: side reinforced
- Rapid Cut: centrally reinforced, rough sides
- Aluminum: specially formulated bond for aluminum and other soft, nonferrous metals; no wax or rubber fillers

BENEFITS

- Engineered for larger cross-sections and/or hard-to-cut materials
- Ideal for small cross-section workpieces
- Free cutting, non-binding; burr- and burn-free cuts
- Free cutting; resist loading
- No surface contamination



NORTON METAL STUD CUTTER CHOP SAW REINFORCED CUT-OFF WHEELS

GOOD CHOICE FOR DRYWALL STUDS

FEATURES

- Stud Cutter: thin, side-reinforced; with high-performance aluminum oxide abrasive

BENEFITS

- Designed specifically for cutting steel studs



NEW

NORTON DIALAST DIAMOND CHOP SAW REINFORCED CUT-OFF WHEELS

DESIGNED FOR CUTTING STEEL, METAL STUDS, STAINLESS STEEL, NONFERROUS MATERIALS, TILE, BRICK, PLASTIC AND MUCH MORE

FEATURES

- A combination of high-quality diamond and advanced brazed single-layer bonding technology
- Environmentally friendly grinding
- Engineered with sound-dampening technology

BENEFITS

- Extra-long life vs. conventional abrasives or other vacuum-brazed diamond tools
- Retains the diamond grains and wheel shape for full life with low spark, while keeping a continuous grinding depth
- Less blade changes reduce downtime and labor costs
- Generate minimal dust
- Makes the blade environmentally-friendly when cutting indoors or out

AVAILABILITY

									
TIER:			BEST	BETTER	BETTER	GOOD	GOOD	GOOD	GOOD
TRADENAME:			NORTON DIALAST	NORTON BLUEFIRE	NORTON BLUEFIRE	NORTON GEMINI	NORTON GEMINI	NORTON METAL	NORTON MASONRY
SHAPE:			Type 01	Type 01	Type 01	Type 01	Type 01	Type 01	Type 01
ABRASIVE:			Diamond	Zirconia Alumina/ Aluminum Oxide	Zirconia Alumina/ Aluminum Oxide	Aluminum Oxide	Aluminum Oxide	Aluminum Oxide	Silicon Carbide
REINFORCING:				Side	Central	Side	Central	Side	Side
MATERIAL:				STAINLESS	STAINLESS	STAINLESS	STAINLESS	STAINLESS	
			STAINLESS	STEEL/METAL	STEEL/METAL	STEEL/METAL	STEEL/METAL	STEEL/METAL	MASONRY
SIZE (D x T x H)	MAX. RPM	STD. PKG.	PART #	PART #	PART #	PART #	PART #	PART #	PART #
Type 01 Straight Cut-off									
10 x 7/64 x 1	6,110	10				66253106109 LL			
12 x 7/64 x 1	5,095	10		66252843250		66253207554 LL	66253214561 RC		
	5,095	5						07660789400	
14 x 3/32 x 1	4,365	10				66253306627 FC	66253313588 RC	66252835554	
	4,365	10				66253306626 LL		07660789405 STUD	
	4,365	5						07660789399	
14 x 7/64 x 1	4,365	10		66252843252 FC	66252843254 RC				
	4,365	10		66252843253 LL					
	4,365	25							
	4,365	10				66253314816 ALU		07660703970 5 Pk	07660789402
14 x .155 x 1	5,400	1	70184694053						
16 x 3/32 x 1	3,820	10				66253410198 LL			
16 x 7/64 x 1	3,820	10		66252843256 FC					
	3,820	10		66252843257 LL					

CUT-OFF WHEEL DESCRIPTION CODES

BLANK = ALL PURPOSE	ALU = ALUMINUM	FC = FREE CUT	LL = LONG LIFE	RC = RAPID CUT	STUD = STUD CUTTER
■ = MASONRY	■ = STAINLESS	■ = STEEL / METAL			





CATEGORY DEFINITION

The Norton stationary saw reinforced cut-off wheel line consists of Type 01 straight 10" - 24" wheels, designed to fit on fixed-base stationary saws that are free-standing or mounted on a workbench.

- APPLICATIONS:** Primary applications are cutting of all metal parts (flat stock, bars, studs, pipes, tubes, angle iron, cable), wire rope and hydraulic hose used in fabrication, construction and plant maintenance.
- SIZE RANGE:** 10" – 20" diameter
- THICKNESS RANGE:** 3/32", 1/8", 5/32", 3/16"
- ABRASIVE GRAIN:** Zirconia Alumina/Aluminium Oxide Blend, Aluminum Oxide, Silicon Carbide
- SHAPE:** Type 01 Straight

CROSS REFERENCE GUIDE



	TOTAL PERFORMANCE		INITIAL PRICE		SPECIALTY	
	BETTER BlueFire	GOOD Gemini Free Cut	Gemini Long Life	Gemini Rapid Cut*	Norton Masonry	GOOD Foundry Cut**
Abmast	Z 24 R3	A 30 R	—	—	—	AC 24 R3
Brilliant	—	GP Fast Cut	GPX Long Life	XL , XLX	—	—
Bullard	—	A30-R	A30-T	A300	C20R	—
Camel	ZA24-R	A24-R, A46-T	—	—	C24-R	WA24-S
Flexovit	—	A30RB Multi Purpose	A30SB Long Life, A24TB Long Life	—	C24RB	AC24PB Heavy Duty
Metabo	—	A30N, A30R	A30S, A30V	—	C30S	—
Pearl	SRT36	A30P Premium, A30Q Silver Line	A30S Premium, A36R Premium	—	C24 Silver Line	—
Pferd	ZA 24 Q/R SG-HD	A 24 N/P SG-HD	A 24 Q/S SG-HD	—	C 24 0 SG	—
Sait	—	A24N, A36R	A24R	—	C24R	—
Tyrolit	—	A30BF	—	—	C30BF	—
Walter	—	A-24-FC	A-24-RIP	—	—	—

* FOR BURR-FREE APPLICATIONS, PLEASE SEE CENTRALLY-REINFORCED BLUEFIRE RAPID CUT AND GEMINI RAPID CUT WHEELS IN CHOP SAW CUT-OFF WHEEL SECTION OR AT WWW.NORTONABRASIVES.COM
 ** FOR FOUNDRY AND OTHER PRODUCTION CUT-OFF WHEELS, PLEASE REFER TO THAT SECTION OF THIS NORTON FULL LINE CATALOG #7362 OR AT WWW.NORTONABRASIVES.COM

AVAILABILITY



TIER:	BETTER	GOOD	GOOD	GOOD		
TRADENAME:	NORTON BLUEFIRE	NORTON GEMINI FREE CUT	NORTON GEMINI LONG LIFE	NORTON MASONRY		
SHAPE:	Type 01	Type 01	Type 01	Type 01		
ABRASIVE:	Zirconia Alumina/ Aluminum Oxide	Aluminum Oxide	Aluminum Oxide	Silicon Carbide		
MATERIAL:	STAINLESS STEEL/METAL	STAINLESS STEEL/METAL	STAINLESS STEEL/METAL	MASONRY		
SIZE (D x T x H)	MAX. RPM	STD. PKG.	PART #	PART #	PART #	PART #

SIZE (D x T x H)	MAX. RPM	STD. PKG.	PART #	PART #	PART #	PART #
Type 01 Straight Cut-off						
10 x 3/32 x 5/8	6,110	10	66252843248	66253106101 FC	66253106102 LL	
	6,110	5				07660789391
12 x 1/8 x 1	5,095	10	66252843249		66253207548 LL	
	5,095	5				07660789350
14 x 1/8 x 1	4,365	10	66252843251	66253306609 FC	66253306611 LL	
	4,365	5				07660789353
16 x 1/8 x 1	3,820	10		66253422942		
16 x 5/32 x 1	3,820	10	66252843255	66253410183 FC	66253410184 LL	
18 x 5/32 x 1	3,015	10		66253410185 FC		
20 x 5/32 x 1	2,710	5	66252843258 FC	69078609031 FC	69078609032 LL	
	2,710	5	66252843259 LL			
20 x 3/16 x 1	2,710	5		69078609033 FC	69078609034 LL	

CUT-OFF WHEEL DESCRIPTION CODES

BLANK = ALL PURPOSE FC = FREE CUT LL = LONG LIFE ■ = STAINLESS ■ = STEEL / METAL ■ = MASONRY



CATEGORY DEFINITION

Foundry cut-off wheels are designed with abrasives, bonds and reinforcement types specific to machine parameters and materials. Most of the specifications are non-stock for this section and the stock listing is designed to provide popular size and starting specifications.

SIZE RANGE: Reinforced: 12" – 30" diameter; Non-reinforced: 12" – 20" diameter

GRIT RANGE: 20 – 46 grit

ABRASIVE GRAIN: Ceramic Alumina, Zirconia Alumina, Aluminum Oxide

REINFORCEMENT: **Reinforced:** Engineered with strengthening fabric or filaments, which make wheels resistant to cross-bending breakage. All portable cut-off, swingframe, locked-head push-through and foundry chop stroke operations require reinforced cut-off wheels.

B: One or more full diameter pieces of filament molded inside each wheel. This construction leaves the abrasive exposed on the side of the wheel, improving freeness of cut. Used for fixed work operations with low probability of side pressure.

N: Full diameter pieces of reinforcement on the side of the wheel. Offers greatest possible resistance to side pressure and bending.

Non-Reinforced: Designed for use on fixed-base types of machines where the work is securely clamped and guarded, and where the wheel operates on a controlled cutting plane.

W: Reinforcement around the center hole only. These wheels are not considered to be truly reinforced.

SIDE PATTERNS: **Smooth sides:** Used for precision cutting applications

Rough (R) sides: Abrasive particles protrude from sides of wheel
Used wet or dry on most metals

MATERIAL-TO-PRODUCT RECOMMENDATION GUIDE

	BEST HIGHEST PRODUCTIVITY LOWEST TOTAL COST	BETTER EXCELLENT BLEND OF PERFORMANCE & PRICE	GOOD CONSISTENT PERFORMANCE LOW INITIAL PRICE
Investment Cast Alloys			
Stainless Steel	Quantum Foundry X	BlueFire Foundry X	Foundry X
Titanium	Quantum Foundry X	BlueFire Foundry X	Foundry X
Cast Iron	Quantum Foundry X	BlueFire Foundry X	Foundry X
Cast Steel			
Carbon & Low Alloy	Quantum Foundry X	BlueFire Foundry X	Foundry X
Stainless Steel & High Alloy	Quantum Foundry X	BlueFire Foundry X	Foundry X
Aluminum Alloy	Quantum Foundry X	BlueFire Foundry X	Foundry X
Copper Alloys, Brass, Bronze	Quantum Foundry X	BlueFire Foundry X	Foundry X

CROSS REFERENCE GUIDE



NORTON	BEST Quantum B97	BETTER BlueFire Foundry X	GOOD Foundry X
Allison	TA362 R6 8045HA, YW462 MR B2HA	TA302-T6-B6HA, A46-T6-BX5T6A, HF 1247 K – CHALLENGER	
Avery		TA30-V680	A 3226 C7A, C11922 W071
Buckeye		Steel Shark	
Dia-Tool	BV1734R 710	BV 1397-5284-C	
Flexovit		A24PB, A30RB	
Klingpor	20A24-QBF		
NATAB			T 1584 HA
Rappoid		6Z30U-B3F2	

FEATURED PRODUCTS



EXPANDED OFFERING

NORTON BLUEFIRE FOUNDRY X REINFORCED

BETTER CHOICE ON STAINLESS STEEL, AEROSPACE ALLOYS, CAST IRON, AND STEEL

FEATURES

- Durable zirconia alumina/aluminum oxide blend with Foundry X bond technology

BENEFITS

- Excellent value on stainless steel and exotic aerospace alloys
- More aggressive; can withstand demanding applications
- Improved durability and heat resistance result in longer abrasive life, showing up to 80% better G-ratios (material removed/wheel wear); the most cost effective wheels



EXPANDED OFFERING

NORTON U57A FOUNDRY X REINFORCED

GOOD CHOICE ON GENERAL PURPOSE APPLICATIONS

FEATURES

- Strong aluminum oxide abrasive with Foundry X bond technology

BENEFITS

- Consistent performance
- Tough and versatile abrasive
- Low initial price

AVAILABILITY REINFORCED



TIER:
BRAND:
TRADENAME:
ABRASIVE:

BETTER

GOOD

Norton

Norton

BLUEFIRE FOUNDRY X

FOUNDRY X

Zirconia Alumina/ Aluminum Oxide

Aluminum Oxide

SIZE (D x T x H)	MAX. RPM	STD. PKG.	SPEC.	PART #	SPEC.	PART #
Type O1 Straight Cut-off – Foundry Reinforced						
14 x 1/8 x 1	4,365	10	NV24-TB75N	66253347674	U57A30-TB75N	66253345779
	4,365	10	NV24-VB75N	66253179193	U57A30-VB75N	66253179191
	4,365	10	NV24-YB97N	66253347698	U57A30-YB97N	66253347692
16 x 5/32 x 1	3,820	10	NV24-TB75N	66253347676	U57A30-TB75N	66253345781
	3,820	10	NV24-VB75N	66253179147	U57A30-VB75N	66253179148
	3,820	10	NV24-YB97N	66253347693	U57A30-YB97N	66253347700
20 x 5/32 x 1	2,710	10	NV24-TB75N	66253347683	U57A30-TB75N	66253347546
	2,710	10	NV24-VB75N	66253179363	U57A30-VB75N	66253179364
	2,710	10	NV24-YB97N	66253347694	U57A30-YB97N	66253347701
20 x 3/16 x 1	2,710	10	NV24-TB75B	66253347684	U57A30-TB75B	66253347547
	2,710	10	NV24-VB75B	66253179366	U57A30-VB75B	66253179367
	2,710	10	NV24-YB97B	66253347699	U57A30-YB97B	66253347702
24 x 7/32 x 1-3/4	2,260	10	NV24-TB75B	66253347685	U57A30-TB75B	66253347549
	2,260	10	NV24-VB75B	66253179374	U57A30-VB75B	66253179375
	2,260	10	NV24-YB97B	66253347697	U57A30-YB97B	66253347703
30 x 1/4 x 1-3/4	1,810	10	NV24-TB75B	66253347722	U57A30-TB75B	66253347720
	1,810	10	NV24-YB97B	66253347723	U57A30-YB97B	66253347721

Ask your Norton representative about Norton Quantum Foundry X ceramic alumina made-to-order wheels.

AVAILABILITY NON-REINFORCED



TIER:
BRAND:
TRADENAME:
ABRASIVE:

BETTER

GOOD

Norton

Norton

U57A

GEMINI

Aluminum Oxide

Aluminum Oxide

SIZE (D x T x H)	MAX. RPM	STD. PKG.	SPEC	PART #	SPEC	PART #
Type O1 Straight Cut-off – Foundry Non-Reinforced R-Sides						
12 x 3/32 x 1	5,095	10	U57A461-PB25	66253261887		
16 x 1/8 x 1	3,820	10			AP	66253422942
20 x 1/8 x 1	2,710	10	U57A304-VB25W	69078665497		

CUT-OFF DESCRIPTION CODES
AP = ALL PURPOSE
Where an excellent blend of cut rate and life is needed



CATEGORY DEFINITION

Reinforced and non-reinforced engineered cut-off wheels for cutting all types of tool steel with fixed-based cut-off machines.

APPLICATIONS:	Reinforced cut-off wheels are designed to resist breakage caused by severe cross-bending and are required on any operation where the work is not securely clamped. Non-Reinforced cut-off wheels are designed for use on fixed-based machines where the work is securely clamped, guarded, and where the wheel operates on a controlled cutting plane.
SIZE RANGE:	6" – 12" diameter
GRIT RANGE:	36 – 90 grit
ABRASIVE GRAIN:	Aluminum Oxide
BOND:	Resinoid, Rubber, and Shellac
SHAPE:	Type 01 Straight

CROSS REFERENCE GUIDE

NORTON	BETTER		
	Reinforced A60-OBNA2	Reinforced 57A364-TB25N	Non-Reinforced 57A60-M8B
Bates	A602-T-BF	A36-R-BF	-
Buffalo	A60-R-BF2	-	-
Dia. Tool	A80-SP	A46-SP	-
Radiac	A54-N6-B20	-	A54-N6-B20
Tyrolit	A60-QBF38A2	-	-

TECHtip

- Smooth side pattern – Used when a precise thickness tolerance is needed
- Rough (R) sides pattern – Abrasive particles protrude from sides of wheel; used wet or dry on most metals

TROUBLESHOOTING GUIDE

PROBLEM	POSSIBLE CAUSES	SUGGESTED CORRECTION
Poor cut rate	Insufficient power used Wheel too hard Contact area too large Wheel too coarse Wheel side out of truth	Increase feed or pressure to full power Use softer grade, or thinner wheel Reduce contact area Use finer grit Check spindle runout
Non-square cuts	Work not clamped properly Misaligned spindle bearings Poor coolant distribution Wheel is too hard	Check clamp and clean to remove swarf Check for bearing truth and alignment Ensure equal volume of coolant to each wheel side Use softer acting wheel: softer grade, or finer grit
Workpiece burn	Insufficient feed rate Poor coolant flow Wheel is too coarse Wheel is too hard Wheel is running out Wheel speed is too slow	Work machine to maximum power available Increase volume and direct at cutting point Use finer grit or more machine power Use softer grade wheel Check spindle and flanges Ensure tight flanges and maximum safe operating speed being used
Poor finish	Too much burr Wheel too coarse	Use finer grit, or softer grade Use finer grit

TECHtip

- Wheels with a "W" reinforcement (reinforcement around the hole) are not considered to be truly reinforced.
- Clamp or fixture the workpiece for straightest cuts.
- Run wheels at the highest possible speed marked on the wheel and make cuts as quickly as possible. Do not overspeed wheels.
- It is recommended that a cut-off machine should have 1 horsepower for every inch of wheel diameter. For less than this, we recommend using a softer specification.
- Using a harder grade wheel increases wheel life, but it also increases burn, power required and decreases cut rate.
- Using a coarser grit wheel increases wheel life and cut rate, but it also increases burr and power required.

FEATURED PRODUCTS



TOOLROOM REINFORCED CUT-OFF WHEELS

BETTER CHOICE FOR CUTTING TOOL STEEL ON FIXED-BASED MACHINES WHEN WORK IS NOT SECURELY CLAMPED

FEATURES

- OBNA2 – side reinforced, resin bond
- B25N – constructed with full diameter fiberglass reinforcement

BENEFITS

- Yields maximum cut rate and minimum kerf loss; ideal when thin cut is desired
- Versatile; durable, free cutting; offer greatest stiffness

AVAILABILITY

SIZE (D x T x H)	MAX. RPM	STD. PKG.	TIER: BETTER	
			SPEC.	PART #
Type O1 Straight Cut-off – Reinforced				
6 x .035 x 1/2	10,190	25	A60-OBNA2	66252835053
6 x .035 x 1-1/4	10,190	25	A60-OBNA2	66252835055
6 x .060 x 1/2	10,190	25	A60-OBNA2	66252835164
6 x .060 x 1/2	10,190	25	57A364-TB25N	66252822969
6 x .060 x 1-1/4	10,190	25	A60-OBNA2	66252835165
7 x .035 x 1/2	8,730	25	A60-OBNA2	66252938786
7 x .035 x 1-1/4	8,730	25	A60-OBNA2	66252938788
7 x .060 x 1/2	8,730	25	A60-OBNA2	66252938816
7 x .060 x 1-1/4	8,730	25	A60-OBNA2	66252938796
7 x .060 x 1-1/4	8,730	25	57A364-TB25N	66252922676

SIZE (D x T x H)	MAX. RPM	STD. PKG.	TIER: BETTER	
			SPEC.	PART #
Type O1 Straight Cut-off – Reinforced				
8 x .035 x 1/2	7,640	25	A60-OBNA2	66253043014
8 x .035 x 1-1/4	7,640	25	A60-OBNA2	66253042980
8 x .060 x 1/2	7,640	25	A60-OBNA2	66253043009
8 x .060 x 1-1/4	7,640	25	A60-OBNA2	66253042983
8 x .060 x 1-1/4	7,640	25	57A364-TB25N	66253022705
10 x .060 x 5/8	6,110	25	A60-OBNA2	66253149317
10 x .060 x 1-1/4	6,110	25	A60-OBNA2	66253149186
12 x .060 x 1	5,095	10	A60-OBNA2	66253261811
12 x .075 x 1	5,095	10	A60-OBNA2	66253261910
12 x .075 x 1-1/4	5,095	10	A60-OBNA2	66253261858



TOOLROOM NON-REINFORCED CUT-OFF WHEELS

BETTER CHOICE FOR CUTTING TOOL STEEL ON FIXED-BASED MACHINES WHEN THE WORK IS SECURELY CLAMPED

FEATURES

- B bond (smooth sides)
- B25 bond (smooth sides)
- E7 bond (smooth sides)
- R30 bond (smooth sides)

BENEFITS

- A mild acting resin bond for light cut-off applications
- A versatile, free-cutting, more durable resin bond
- Ideal for dry cutting metal in high production runs
- A shellac bond with very mild cutting action, recommended for highly critical applications where no burr, heat checks, or discoloration is permitted
- Mild acting rubber bond primarily for wet, ultra-thin cutting

AVAILABILITY

SIZE (D x T x H)	MAX. RPM	STD. PKG.	TIER: BETTER	
			SPEC.	PART #
Type O1 Straight Cut-off – Non-Reinforced				
6 x .015 x 1-1/4	6,370	25	57A90-ROR30	66252822953
6 x .020 x 1-1/4	6,370	25	57A90-ROR30	66252822954
6 x .035 x 1-1/4	6,370	25	57A60-M8B	66252822958
6 x .060 x 1/2	7,640	25	57A541-RB25	66252822970
6 x .060 x 1-1/4	7,640	25	57A60-M8B	66252822975
7 x .035 x 1-1/4	5,460	25	57A60-M8B	66252922983
			57A60-08B	66252922986
			57A60-Q8B	66252922987
7 x .035 x 1-1/4	5,460	25	57A601-PB25	66252922988
			57A601-RB25	66252922989
7 x .035 x 1-1/4	5,185	25	57A60-OE7	66252922985
			23A601-PB25	66252938701
7 x .050 x 1-1/4	5,460	25	23A601-PB25	66252938724*
7 x .060 x 1/2	6,550	25	57A60-08B	66252922672

*EXCEPTION: ROUGH SIDES

SIZE (D x T x H)	MAX. RPM	STD. PKG.	TIER: BETTER	
			SPEC.	PART #
Type O1 Straight Cut-off – Non-Reinforced				
7 x .060 x 1-1/4	6,550	25	57A46-M8B	66252922677
			57A60-M8B	66252922681
			57A60-08B	66252922684
7 x .090 x 1-1/4	6,550	25	57A60-OE7	66252922683
			57A60-M8B	66252922690
7 x .125 x 1-1/4	6,550	25	57A60-M8B	66252922692
8 x .035 x 1-1/4	4,775	25	57A60-N8B	66253022694
8 x .060 x 1/2	5,730	25	57A60-M8B	66253022702
8 x .060 x 1-1/4	5,730	25	57A60-M8B	66253022708
8 x .060 x 1-1/4	4,540	25	57A60-OE7	66253022709
10 x .060 x 5/8	4,585	25	57A46-Q8BW	66253122816
			57A60-M8BW	66253122818
10 x .090 x 5/8	4,585	25	57A60-M8BW	66253122824



CATEGORY DEFINITION

The Norton metallurgical line of Type O1 straight cut-off wheels was developed specifically for sectioning off metal samples; burr-free cutting, minimal burn and distortion.

APPLICATIONS: Designed specifically for cutting off metal samples ranging from mild steel to super alloys on fixed-based machinery by scientists, engineers, and lab technicians

SIZE RANGE: 9" – 13.75" diameter

MATERIALS CUT: Steels, and Titanium / Titanium Alloys

CROSS REFERENCE GUIDE

Size	Material	NORTON		BUEHLER		LECO		STRUERS	
		Spec.	Part #	Metabrase Part #	BuehlerMet II Part #	Part #	Part #	Part #	Axitom/-5 Part #
9 x .063 x 1-1/4 (229mm x 1.6mm x 32mm)	Very Hard Steels (Rc 55 - 68)	ML-109	66253117874	10-4110-010					60A24*
	Medium Steels (Rc 30 - 40)	ML-309	66253117877	10-4116-010	10-5112-010	811-043-010			40A24*
	Soft Steels (Rc 20 - 30)	ML-409	66253117828	10-4120-010	10-5116-010	811-049-010			30A24*
10 x .063 x 1-1/4 (254mm x 1.6mm x 32mm)	Very Hard Steels (Rc 55 - 68)	ML-110	66253117879	10-4210-010		808-673	812-231		60A25•
	Hard Steels (Rc 40 - 55)	ML-210	66253117880	10-4212-010	10-5210-010	811-059-010	810-310-010		54A25•
	Medium Steels (Rc 30 - 40)	ML-310	66253117881	10-4216-010	10-5212-010	811-067-010	810-310-010		40A25•
	Soft Steels (Rc 20 - 30)	ML-410	66253117830	10-4220-010	10-5216-010	811-073-010			30A25•
12 x .078 x 1-1/4 (305mm x 2.0mm x 32mm)	Very Hard Steels (Rc 55 - 68)	ML-112	66253322151	10-4410-010		808-674	811-065-010		60A30†
	Hard Steels (Rc 40 - 55)	ML-212	66253322152	10-4412-010	10-5410-010	811-081-010	810-311-010		50A30†
13.75 x .098 x 1-1/4 (350mm x 2.5mm x 32mm)	Very Hard Steels (Rc 55 - 68)	ML-114	66253322863	10-4310-010		808-675	812-232		60A35▲ 50A35
	Hard Steels (Rc 40 - 55)	ML-214	66253322156	10-4312-010	10-5310-010	809-346	811-977-010		50A35▲ 40A35

* DISCOTOM/LABOTOM • DISCOTOM-5/-6/LABOTOM-3 † UNITOM/DISCOTOM-50/-60/-65 ▲ EXOTOM/UNITOM-2/-5/-50

AVAILABILITY

SIZE (D x T x H)	MAX. RPM	STD. PKG.	PRODUCT #	APPLICATION	TIER:	BEST PART #
Type O1 Straight Cut-off – Non-Reinforced						
9 x .063 x 1-1/4 (229mm x 1.6mm x 32mm)	4,025	10	ML-109	Very Hard Steels (Rc 55 - 68)		66253117874
	4,025	10	ML-309	Medium Steels (Rc 30 - 40)		66253117877
	5,085	10	ML-409	Soft Steels (Rc 20 - 30)		66253117828
10 x .063 x 1-1/4 (254mm x 1.6mm x 32mm)	3,500	10	ML-110	Very Hard Steels (Rc 55 - 68)		66253117879
	3,500	10	ML-210	Hard Steels (Rc 40 - 55)		66253117880
	3,500	10	ML-310	Medium Steels (Rc 30 - 40)		66253117881
	4,585	10	ML-410	Soft Steels (Rc 20 - 30)		66253117830
12 x .078 x 1-1/4 (305mm x 2.0mm x 32mm)	3,820	10	ML-112	Very Hard Steels (Rc 55 - 68)		66253322151
	3,820	10	ML-212	Hard Steels (Rc 40 - 55)		66253322152
13.75 x .098 x 1-1/4 (350mm x 2.5mm x 32mm)	2,770	10	ML-114	Very Hard Steels (Rc 55 - 68)		66253322863
	2,770	10	ML-214	Hard Steels (Rc 40 - 55)		66253322156

B82 BOND WHEELS

A HIGH-PERFORMANCE RESIN BOND FOR WET CUTTING METALLURGICAL APPLICATIONS

AVAILABILITY

SIZE (D x T x H)	MAX. RPM	STD. PKG.	SPEC.	PART #	TIER:	BETTER
Type O1 Straight Cut-off – Non-Reinforced						
10 x 1/16 x 1-1/4	4,585	5	88A901-HB82 Metlab	66253149449		
12 x 1/16 x 1-1/4	3,820	5	88A901-HB82 Metlab	66253262172		



CATEGORY DEFINITION

For consistent, quality performance in foundries, welding shops, fabrication facilities, steel mills and shipyards, Norton snagging wheels maximize your productivity. Used on horizontal/straight shaft grinders or right angle cup portable grinders.

- APPLICATIONS:** Removing flaws, cracks, gates, risers and parting lines, smoothing weld seams, cleaning castings, and rough beveling
- SIZE RANGE:** Type 01 Straight Wheels: 2-1/2" – 8" diameter
 Type 06 and 11 Cup Wheels: 4" – 6" diameter
 Cones and Plugs: Type 16, 17, 17R, 18 and 18R
- GRIT RANGE:** 14 – 24
- ABRASIVE TYPES:** Zirconia Alumina NZ and NV; Zirconia Alumina/Silicon Carbide Blend NVC; Aluminum Oxide 57A and Metal; Aluminum Oxide/Silicon Carbide Blend 57AC, Silicon Carbide 37C

MATERIAL-TO-PRODUCT RECOMMENDATION GUIDE

		BEST HIGHEST PRODUCTIVITY LOWEST TOTAL COST	BETTER EXCELLENT BLEND OF PERFORMANCE & PRICE	GOOD CONSISTENT PERFORMANCE LOW INITIAL PRICE
Iron	Gray Ductile/Malleable Dirty/Scale-covered	NorZon Plus NZ14-R NorZon Plus NZ14-R	BlueFire NV16-Q BlueFire NV16-Q BlueFire NVC16-Q	Gemini 57A16-Q, Metal Gemini 57A16-Q, Metal Gemini 57AC16-Q
Steel	Carbon and Low Alloy Stainless and High Alloy	NorZon Plus NZ16-Q NorZon Plus NZ16-P	BlueFire NV16-Q BlueFire NV16-Q	Gemini 57A16-Q, Metal Gemini 57A16-Q, Metal
Aluminum, Copper, Brass, & Bronze Alloys			BlueFire NVC16-Q	Gemini 57AC16-Q

NOTE: GRADE, GRIT AND ABRASIVE TUNING MAY BE NECESSARY TO OBTAIN OPTIMUM PERFORMANCE

CROSS REFERENCE GUIDE FOR TYPE 01, 06 AND 11

NORTON	TOTAL PERFORMANCE ←			INITIAL PRICE →		
	BEST NorZon Plus NZ	BETTER BlueFire NV	BlueFire NVC	GOOD Gemini 57A	Gemini 57AC	Gemini 37C
Brilliant	—	ZA16QB	—	A16QB	—	C16QB
Bullard	—	ZA16PB	—	A16R	AC16	C16P
Camel	—	—	—	A	CA	C
Flexovit	ZA16PB	—	—	A16QB	AC16QB	C16PB
Gulf States	Zirconium	—	—	A16	—	C16
Pacific	Z, Z-GPC	—	—	A	CA	—
Pearl	—	—	—	A16Q	—	C16-Q
Pferd	ZA 16 Q SG	—	—	A 16 Q SG	—	C 16 Q SG
Sait	—	Z16	—	A16, 20	CA16	C16
Tyrolit	—	—	—	A16PB	—	C16PB
Walter	—	—	—	A	—	C

FEATURED PRODUCTS



NORTON NORZON PLUS WHEELS, CONES AND PLUGS

BEST CHOICE FOR HEAVY-DUTY STOCK REMOVAL ON HIGH-HORSEPOWER GRINDERS

FEATURES

- NZ Plus (NorZon) – premium zirconia alumina grain

BENEFITS

- Engineered for high-powered machines 10X life, 50% faster grinding versus aluminum oxide products



NORTON BLUEFIRE SNAGGING WHEELS, CONES AND PLUGS

BETTER CHOICE FOR STOCK REMOVAL ON HIGH- AND MEDIUM-HORSEPOWER GRINDERS

FEATURES

- More friable zirconia alumina grain and durable resin bond technologies
- NVC – zirconia alumina/silicon carbide blend

BENEFITS

- Higher metal removal rates, faster, freer-cutting than standard zirconia alumina blends
- Up to 5X the life of aluminum oxide products; better grinding action
- Highly effective on dirty, scale-covered castings



FEATURED PRODUCTS



VENDIBLE

NORTON GEMINI

GOOD CHOICE FOR STEEL AND FERROUS METALS AS WELL AS SPECIALTY APPLICATIONS IN ALUMINUM AND FOUNDRIES

FEATURES

- Quality aluminum oxide

BENEFITS

- Consistent performance at a competitive price



NEW

NORTON METAL/MASONRY

GOOD CHOICE FOR STEEL/FERROUS METAL AND MASONRY APPLICATIONS WITH LOW INITIAL PRICE

FEATURES

- Aluminum oxide abrasive
- Low initial price point

BENEFITS

- Engineered for all steel/ferrous materials
- Best starting specification for end user unable to measure performance

AVAILABILITY

TIER:
 TRADENAME:
 SHAPE:
 ABRASIVE:



BEST

NORTON NORZON PLUS

Type 01

Zirconia Alumina



BETTER

NORTON BLUEFIRE

Type 01

Zirconia Alumina NV
 Zirconia Alumina/Silicon Carbide NVC



GOOD

NORTON GEMINI

Type 01

Aluminum Oxide 57A, Silicon Carbide 37C,
 Aluminum Oxide/Silicon Carbide 57AC

SIZE (D x T x H)	MAX. RPM	STD. PKG.	SPEC	PART #	SPEC	PART #	SPEC	PART #
Type 01 Straight								
2-1/2 x 1/2 x 3/8	21,700	20					57A24-R	66243522381
3 x 1/4 x 3/8	20,370	25			NV20-T	66253343872**	57A24-T	66243528831
3 x 3/8 x 3/8	18,080	10					57A24-R	66243522415
3 x 1/2 x 3/8	18,080	10					57A24-P	66243522417
4 x 1/4 x 3/8	15,280	10			NV20-T	66253344098	57A24-R	66243522221
6 x 1 x 5/8	8,000	5	NZ14-Q	66252838075	NV14-R	66253198589	57A16-QS	66252809563
S Webs	8,000	5	NZ14-R	66252837961				
8 x 3/4 x 5/8	6,000	10			NV14-S	66253344347		
S Webs								
8 x 1 x 5/8	6,000	5	NZ16-O	66253030778	NV16-Q	66253198590		
S Webs	6,000	5	NZ16-Q	66253044532				
	6,000	10			NV14-R	66253 344355		
	6,000	10			NV14-T	66253344365		
	6,000	10			NVC16-Q	66253198592		
Type 06 Straight Cup								
6 x 2 x 5/8-11	6,000	5	NZ16-R	66252838577				
Rim 2" Back 3/4"								
Type 11 Flaring Cup								
4/3 x 2 x 5/8-11	9,070	10	NZ16-Q	66243530761	NV16-Q	66253198583	57A16-Q	66243510512
Rim 3/4" Back 3/4"								
5/3-3/4 x 2 x 5/8-11	7,260	5			NV16-Q	66253146918	57A16-Q	66252809598
Rim 1" Back 3/4"								
6/4-3/4 x 2 x 5/8-11	6,000	5	NZ16-Q	66252838568	NV16-Q	66253146925	57A16-Q	66252825201
Rim 1" Back 3/4"	6,000	5	NZ16-R	66252838566				
6/4-3/4 x 2 x 5/8-11	6,000	5	NZ16-P	66252830765	NV16-Q	66253198584	37C16-P	66252809609
Rim 1-1/2" Back 3/4"	6,000	5			NVC16-Q	66253146922	57A16-Q	66252809618
	6,000	5					57AC16-Q	66252809608
Type 11 Flaring Cup with Steel Back								
4/3 x 2 x 5/8-11	9,070	10			NV16-Q	66253146917		
Rim 3/4" Back 3/4"								
5/3-13/16 x 2 x 5/8-11	7,260	10			NV16-Q	66253146920		
Rim 1" Back 3/4"								
6/4-13/16 x 2 x 5/8-11	6,000	5			NV14-R	66253344373	57A16-Q	66252809599
Rim 1-1/2" Back 3/4"	6,000	5			NV16-Q	66253198586	57AC16-Q	66252809600
	6,000	5			NVC16-Q	66253146929		

** STD.PKG. = 50



AVAILABILITY



TIER:	BEST	BETTER	GOOD	GOOD
TRADENAME:	NORTON NORZON PLUS	NORTON BLUEFIRE	NORTON GEMINI	NORTON METAL
ABRASIVE:	Zirconia Alumina	Zirconia Alumina/Aluminum Oxide	Aluminum Oxide	Aluminum Oxide

SIZE (D x T x H)	MAX. RPM	STD. PKG.	SPEC	PART #	SPEC	PART #	SPEC	PART #	SPEC	PART #
Type 16 Cones										
1 x 3 x 3/8-24 (ME 107019)	36,290	10			NV20-S	66253344376	57A24-R	61463622342	Metal 24	66253349752
1-1/2 x 2-1/2 x 3/8-24 (ME 44436)	24,190	10					57A24-R	61463622349	Metal 24	66253349754
1-1/2 x 3 x 3/8-24 (ME 139029)	24,190	10			NV20-S	66253344377				
1-1/2 x 3 x 5/8-11 (ME 70535)	24,190	10	NZ20-R	61463644231	NV20-S	66253344379	57A24-R	61463622190	Metal 24	66253349757
1-3/4 x 3 x 3/8-24 (ME49226)	20,735	10					57A24-R	61463614503	Metal 24	66253349840
1-3/4 x 3 x 5/8-11 (ME 33432)	20,740	10					57A24-R	61463622195	Metal 24	66253349841
2 x 3 x 5/8-11 (ME 28229)	18,145	10	NZ20-R	61463644232	NV20-S	66253344381	57A24-R	61463622218	Metal 24	66253349846
2-3/4 x 3-1/2 x 5/8-11 (ME 18265)	13,195	10			NV20-S	66253344383	57A24-R	61463622387	Metal 24	66253349855
Type 17 Cones, Square Tip										
1-1/2 / 1/2 x 3 x 3/8-24	24,190	10					57A24-R	61463622194	Metal 24	66253349753
2 / 1/2 x 3 x 5/8-11	18,145	10					57A24-R	61463615722	Metal 24	66253349845
Type 17R Cones, Round Tip										
2 / 3/4 x 3 x 5/8-11 (ME 151373)	18,145	10			NV20-S	66253344384				
Type 18 Plugs, Square Tip										
1-1/2 x 2-1/2 x 3/8-24	24,190	10					57A24-R	61463622217	Metal 24	66253349755
	24,190	1					57A24-R	66253325902		
1-1/2 x 2-1/2 x 5/8-11	24,190	10	NZ20-R	61463644224	NV20-S	66253344385	57A24-R	61463622351		
	24,190	1					57A24-R	66253325905		
1-1/2 x 3 x 5/8-11	24,190	10			NV20-S	66253344386	57A24-R	61463622191	Metal 24	66253349838
	24,190	1					57A24-R	66253325909		
2 x 3 x 5/8-11	18,145	10	NZ20-R	61463644234	NV20-S	66253344387	57A24-R	61463622219	Metal 24	66253349847
	18,145	10			NV24-S	66253344391				
2 x 4 x 5/8-11	18,145	10					57A24-R	61463622366	Metal 24	66253349850
Type 18R Plugs, Round Tip										
1-1/2 x 3 x 3/8-24	24,190	10					57A24-R	61463622192	Metal 24	66253349756
	24,190	1					57A24-R	66253325907		
2 x 3 x 5/8-11	18,145	10			NV20-S	66253344389	57A24-R	61463622220	Metal 24	66253349849

✓ = VENDIBLE PACKAGE. IDEAL FOR VENDING MACHINES & SMALL JOBS.

AVAILABILITY

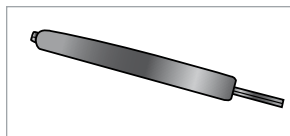

TIER:	GOOD
BRAND:	NORTON
ABRASIVE:	Silicon Carbide

SIZE (T x W x L)	STD. PKG.	SPEC.	PART #
Stock Resinoid Core Files – Silicon Carbide			
1/2 x 1 x 10	5	37C24-SB	61463610314



CATEGORY DEFINITION

Norton snagging wheels maximize your productivity in foundries, welding shops, fabrication facilities, steel mills, and ship yards.

- APPLICATIONS:** Removing unwanted metal on castings, removing flaws and cracks, removing gates, risers and parting lines
- SIZE RANGE:** 24" and 30" diameters in stock; other diameters available as made-to-order
- ABRASIVE GRAIN:** Zirconia Alumina, Zirconia Alumina/Silicon Carbide blend, Aluminum Oxide
- SHAPE:** Type 01 Straight
- REINFORCEMENT:** Strong fiberglass webbing and steel rings for maximum strength

FLOORSTAND SNAGGING WHEEL MATERIAL-TO-PRODUCT RECOMMENDATION GUIDE

Casting Type		BEST HIGHEST PRODUCTIVITY LOWEST TOTAL COST	BETTER EXCELLENT BLEND OF PERFORMANCE & PRICE	GOOD CONSISTENT PERFORMANCE LOW INITIAL PRICE
Iron	Gray	4ZF1434-R5B38S, ZI/25-R, ZI/26-Q	Charger Long Life	Gemini All Purpose
	Ductile / Malleable	4ZF1434-Q5B38S, ZI/25-R, ZI/26-Q	Charger Long Life	Gemini All Purpose
Steel	Carbon and Low Alloy	4NZ1434-R5B38S	Charger Free Cut	Gemini All Purpose
	Stainless and High Alloy	4NZ1634-Q5B38S	Charger Free Cut	Gemini All Purpose

NOTE: GRADE, GRIT AND ABRASIVE TUNING MAY BE NECESSARY TO OBTAIN OPTIMUM PERFORMANCE

SWINGFRAME SNAGGING WHEEL MATERIAL-TO-PRODUCT RECOMMENDATION GUIDE

Casting Type		BEST HIGHEST PRODUCTIVITY LOWEST TOTAL COST	GOOD CONSISTENT PERFORMANCE LOW INITIAL PRICE
Iron	Gray	4ZF1234-R5B38S, ZI/25-R, ZI/26-Q	Gemini All Purpose
	Ductile / Malleable	4ZF1234-R5B38S, ZI/25-R, ZI/26-Q	Gemini All Purpose
Steel	Carbon and Low Alloy	4ZF1434-R5B38S	Gemini All Purpose
	Stainless and High Alloy		Gemini All Purpose
Aluminum Alloy		NZC142-R5B38S	
Copper Alloys / Brass / Bronze		NZC142-R5B38S	

NOTE: GRADE, GRIT AND ABRASIVE TUNING MAY BE NECESSARY TO OBTAIN OPTIMUM PERFORMANCE

TROUBLESHOOTING GUIDE

PROBLEM	POSSIBLE CAUSES	SUGGESTED CORRECTION
Poor stock removal	Insufficient pressure applied Wheel too coarse or hard Inadequate abrasive	Increase pressure to use all available power Use finer grit and/or softer grade wheel Try NorZon, 4ZF, or ZI/25 specification
Grinding costs too high	Wheel acting too soft Low performance specification	Use harder and/or coarser wheel Try NorZon or ZI products
Wheel loading or glazing	Grade too hard Grit too coarse Dirty, scale-covered parts	Try softer grade Try finer grit Try NZC wheels
Wheels "dusty"	Wheel too soft	Try harder grade
Wheel doesn't hold corner or wheel spalling	Wheel too coarse Wheel too soft	Use finer grit and/or 2 grit combination Use harder grade
Burning the workpiece	Wheel too hard Wheel glazed or loaded Grinding pressure too low Grinding pressure too high	Use softer grade Dress the wheel face Increase grinding force Reduce grinding force
Surface finish too rough	Wheel too coarse Wheel speed too slow Worn machine bearings	Try finer grit or try ZI/26 specification Try higher speed machine (Do not exceed maximum operating speed of wheel) Rebuild machine
Vibration	Wheel worn out of round Faulty flanges Bent machine spindle Worn machine bearings	Try truing the wheel Check flanges for flatness and burrs (see ANSI B7.1) Check spindle run-out Rebuild machine
Wheel stalls or slows	Grinding force too high Wheel too hard Machine power too low	Reduce pressure or contact area Use softer grade wheel Replace machine with higher power grinder

FEATURED PRODUCTS

4ZF, 4NZ, ZI, AND NZC WHEELS

BEST CHOICE FOR DEMANDING APPLICATIONS

FEATURES

- 4ZF – for long life
- 4NZ – for sharpness
- ZI – zirconia grain stays sharper, longer
- NZC – zirconia alumina and silicon carbide blend

BENEFITS

- Engineered for high-pressure, heavy-duty, snagging operations, particularly on iron
- Exceptional wheel life
- Developed for low- to medium-pressure operations, especially on steel and steel castings
- Exceptionally high cut rate
- The most operator-friendly wheels
- The choice for iron castings: ZI/25 for tough metal removal, ZI/26 for finer surface finish
- Ideal for dirty, scale-covered castings

CHARGER WHEELS

BETTER CHOICE FOR STRONG PERFORMANCE TO PRICE RATIO

FEATURES

- Strong zirconia alumina abrasive

BENEFITS

- Very good cut rate and life

5ZF AND GEMINI WHEELS

GOOD CHOICE FOR NUMEROUS SMALL JOBS

FEATURES

- Gemini – versatile aluminum oxide formulation
- Low initial price
- 5ZF – zirconia alumina

BENEFITS

- Works well with a variety of machines, horsepower, and operations
- The choice for initial-price-conscious end-users
- Ideal for lower horsepower or low-pressure applications

AVAILABILITY

SIZE (D x T x H)	MAX. RPM	TIER: STD. PKG.	BEST		BETTER		GOOD	
			SPEC.	PART #	SPEC.	PART #	SPEC.	PART #
Type 01 Straight								
24 x 3 x 12	1,990	1	4ZF1234-R5B38S	69083166310			5ZF14-QS	69083166858
HS Steel Rings with Fine Centers, S Webs	1,990	1	ZI/25-R	66253119637			Gemini All Purp.	69083167173
30 x 2 x 12	1,595	1	4NZ1634-Q5B38S	69210421412	Charger Free Cut Charger Long Life	69210421417 69210421418	5ZF14-R	69210467105
HS Steel Rings with Fine Centers, S Webs	1,595	1	4ZF1434-R5B38S	69210466458			Gemini All Purp.	69210417463
	1,595	1	4ZF1634-Q5B38S	69210466460				
	1,595	1	ZI/25-R	66253119636				
	1,595	1	ZI/26-Q	66253119638				
	1,595	1	NZC142-R5B38S	69210421414				

FOR YOUR SAFETY: ALL FLOORSTAND AND SWINGFRAME WHEELS HAVE STRONG FINE CENTERS, STEEL RINGS AND HIGH-STRENGTH FIBERGLASS REINFORCEMENT CONSTRUCTION.

TECHtip

- Always ensure proper mounting of floorstand and swingframe wheels by mounting with arrow down as marked on wheel
- Always use safety guard
- Always run wheel for 1 minute before grinding
- For optimum performance, ensure adequate air pressure and air volume when using pneumatic machines
- Use constant surface foot per minute machines for highest efficiency
- Do not overdress the wheel face
- Avoid loading or glazing by changing the contact angle
- Use pressure assist whenever possible to obtain maximum cut rate



It is the user's responsibility to refer to and comply with ANSI B7.1



CATEGORY DEFINITION

The Norton bench and pedestal wheel line consists of all wheel diameters and arbor sizes, abrasive types and grit sizes. Our offering answers all metal removal, deburring, shaping and sharpening needs: white aluminum oxide for high-speed tool steels, brown aluminum oxide for carbon steel, and silicon carbide for non-ferrous metals and carbide tooling.

- APPLICATIONS:** Offhand deburring and sharpening of parts and tools
- SIZE RANGE:** 5" – 18"
- GRIT RANGE:** 24 – 150
- ABRASIVE TYPES:** Aluminum Oxide (Alundum), Silicon Carbide (Crystolon)
- BUSHINGS:** Telescopic arbor bushings to fit all popular grinders are packaged with the wheel

APPLICATION/GRIT RECOMMENDATION GUIDE

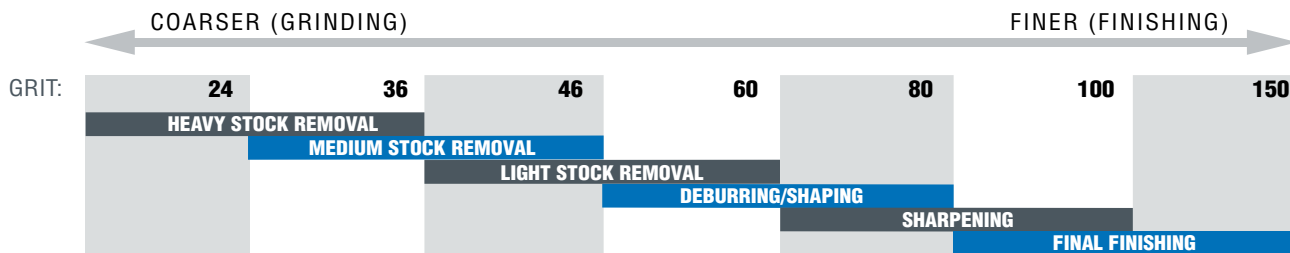

FEATURED PRODUCTS



PREMIUM WHITE ALUMINUM OXIDE

BETTER CHOICE FOR LIGHT METAL REMOVAL AND SHARPENING OF HIGH-SPEED TOOL STEELS (55 RC AND HIGHER)

- | FEATURES | BENEFITS |
|--|---|
| <ul style="list-style-type: none"> ■ White aluminum oxide in a premium vitrified bond | <ul style="list-style-type: none"> ■ Maximum cut rate and cool grinding action on hardened or high-speed tool steels |



NORTON 57A AND 39C ENGINEERED

BETTER CHOICE FOR END USER THAT NEEDS SPECIFIC GRIT SIZE AND HARDNESS FOR ENGINEERED APPLICATIONS

- | FEATURES | BENEFITS |
|--|---|
| <ul style="list-style-type: none"> ■ High quality aluminum oxide or silicon carbide abrasive in a premium vitrified bond system | <ul style="list-style-type: none"> ■ Precision engineered grit size and hardness to maximize cut rate, finish and wheel life ■ 57A for ferrous metals: 39C for nonferrous materials |



NORTON GEMINI ALUMINUM OXIDE

GOOD CHOICE FOR ALL GENERAL-PURPOSE BENCH AND PEDESTAL APPLICATIONS

- | FEATURES | BENEFITS |
|---|--|
| <ul style="list-style-type: none"> ■ Quality, brown aluminum oxide | <ul style="list-style-type: none"> ■ Economical prices; ideal for small job shops and numerous general-purpose applications |



NORTON GEMINI SILICON CARBIDE

GOOD CHOICE FOR ALL GENERAL-PURPOSE BENCH AND PEDESTAL APPLICATIONS ON NONFERROUS MATERIALS AND CARBIDE TOOLING

- | FEATURES | BENEFITS |
|--|--|
| <ul style="list-style-type: none"> ■ Sharp, green silicon carbide | <ul style="list-style-type: none"> ■ Economical prices; ideal for small job shops and numerous general-purpose applications |

AVAILABILITY



TIER: **BETTER**
 BRAND: Norton

TRADENAME: **PREMIUM ALUNDUM**

ABRASIVE: White Aluminum Oxide



TIER: **BETTER**
 BRAND: Norton

TRADENAME: **57A**

ABRASIVE: Brown Aluminum Oxide



TIER: **GOOD**
 BRAND: Norton

TRADENAME: **GEMINI ALUNDUM**

ABRASIVE: Brown Aluminum Oxide

SIZE (D x T x H)	MAX. RPM	MIN./STD. PKG.	SPEC	PART #	MIN./STD. PKG.	SPEC	PART #	MIN./STD. PKG.	SPEC	PART #
5 x 1/2 x 1	4,965				1/5	Medium 60/80	07660788202			
	4,965				1/5	Fine 100/120	07660788201			
5 x 3/4 x 1	4,965				1/5	Coarse 36/46	07660788215			
	4,965				1/5	Medium 60/80	07660788210			
	4,965				1/5	Fine 100/120	07660788205			
5 x 1 x 1	4,965				1/5	Coarse 36/46	07660788230			
	4,965				1/5	Medium 60/80	07660788225			
6 x 1/2 x 1	4,140				1/5	Coarse 36/46	66252836132			
	4,140				1/5	Medium 60/80	66252836131			
	4,140				1/5	Fine 100/120	66252836133			
6 x 3/4 x 1	4,140	1/5	Medium 60	07660788246	1/5	Coarse 36/46	07660788245			
	4,140	1/5	Fine 100	07660788247	1/5	Medium 60/80	07660788240			
	4,140	1/5	Very Fine 150	07660788248	1/5	Fine 100/120	07660788235			
6 x 1 x 1	4,140	1/5	Medium 60	07660788261	1/5	Coarse 36/46	07660788260			
	4,140	1/5	Fine 100	07660788262	1/5	Medium 60/80	07660788255			
	4,140	1/5	Very Fine 150	07660788263	1/5	Fine 100/120	07660788250			
7 x 1 x 1	3,600				1/5	Coarse 36/46	07660788275			
	3,600				1/5	Medium 60/80	07660788270			
	3,600				1/5	Fine 100/120	07660788265			
8 x 3/4 x 1	3,600				1/5	Coarse 36/46	07660788278			
	3,600				1/5	Medium 60/80	07660788277			
	3,600				1/5	Fine 100/120	66253042317			
8 x 1 x 1	3,600	1/5	Medium 60	07660788281	1/5	Very Coarse 24	66253044454			
	3,600	1/5	Fine 100	07660788282	1/5	Coarse 36/46	07660788286			
	3,600	1/5	Very Fine 150	07660788283	1/5	Medium 60/80	07660788285			
10 x 1 x 1-1/4	2,485				1/5	57A46-MVBE	66253116274	1/2	Very Coarse 24	66253160788
	2,485				1/5	57A60-MVBE	66253116273	1/2	Coarse 36/46	07660788295
	2,485							1/2	Medium 60/80	07660788290
	2,485							1/2	Fine 100/120	66253160350
10 x 1-1/4 x 1-1/4	2,485							1/2	Coarse 36/46	66253161250
	2,485							1/2	Medium 60/80	66253161251
10 x 1-1/2 x 1-1/4	2,485				1/5	57A46-MVBE	66253116280	1/2	Coarse 36/46	66253161393
	2,485							1/2	Medium 60/80	66253161395
12 x 1 x 1-1/4	2,070				1/5	57A46-MVBE	66253220947			
12 x 1-1/2 x 1-1/2	2,070							1/2	Coarse 36/46	66253263052
	2,070							1/2	Medium 60/80	66253263053
12 x 2 x 1-1/2	2,070				1/4	57A30-MVBE	66253220951	1/2	Very Coarse 24	66253263054
	2,070				1/4	57A36-OVBE	66253220952	1/2	Coarse 36/46	66253263055
	2,070				1/4	57A46-MVBE	66253220953	1/2	Medium 60/80	66253263056
	2,070				1/4	57A60-MVBE	66253220955			
14 x 2 x 1-1/2	1,800				1/3	57A24-QVBE	66253319972			
	1,800				1/3	57A36-OVBE	66253319973			
	1,800				1/3	57A46-MVBE	66253319974			
14 x 2-1/2 x 1-1/2	1,800				1/2	57A24-QVBE	66253319976			
	1,800				1/2	57A46-MVBE	66253319975			
14 x 3 x 1-1/2	1,800				1/2	57A36-OVBE	66253319977			
18 x 3 x 1-1/2	1,275				1/2	57A24-QVBE	66253462610			



AVAILABILITY



BETTER

TIER:

Norton

BRAND:

TRADENAME:

39C (GREEN) /37C (GRAY)

ABRASIVE:

Silicon Carbide



BETTER

Norton

GEMINI CRYSTOLON

Green Silicon Carbide

SIZE (D x T x H)	MAX. RPM	MIN./STD. PKG.	SPEC	PART #	MIN./STD. PKG.	SPEC	PART #
6 x 1/2 x 1	4,140				1/5	Medium 60	66252836571
	4,140				1/5	Fine 80	66252836572
	4,140				1/5	Extra Fine 120	66252836573
6 x 3/4 x 1	4,140				1/5	Medium 60	66252837190
	4,140				1/5	Fine 80	66252837191
	4,140				1/5	Extra Fine 120	66252837192
6 x 1 x 1	4,140				1/5	Medium 60	66252837187
	4,140				1/5	Fine 80	66252837193
	4,140				1/5	Extra Fine 120	66252837194
7 x 1 x 1	3,600				1/5	Medium 60	66252942300
	3,600				1/5	Fine 80	66252942301
	3,600				1/5	Extra Fine 120	66252942302
8 x 1 x 1	3,600				1/5	Medium 60	66253044087
	3,600				1/5	Fine 80	66253044534
	3,600				1/5	Extra Fine 120	66253044535
10 x 1 x 1-1/4	2,485	1/5	39C60-IVK	66253116262	1/2	Medium 60	66253144536
	2,485				1/2	Fine 80	66253160366
10 x 1-1/2 x 1-1/4	2,485	1/5	39C60-IVK	66253116265			
12 x 2 x 1-1/4	2,070				1/2	Medium 60	66253263359
	2,070				1/2	Fine 80	66253263360
12 x 2 x 1-1/2	2,070	1/4	39C60-KVK	66253220942			
14 x 2 x 1-1/2	1,800	1/3	37C24-RVK	66253319967			
	1,800	1/3	39C60-JVK	66253319968			

Bench and Pedestal Wheel Arbor Bushings

WHEEL DIAMETER	WHEEL CENTER HOLE	1/2"	5/8"	3/4"	7/8"	1"	1-1/4"
5", 6", 7"	1"	•	•	•	•		
8"	1"		•	•	•		
10"	1-1/4"			•	•	•	
12" x 2"	1-1/4"					•	
12" and 14"	1-1/2"					•	•

THESE SIZE BUSHINGS SHIPPED FREE OF CHARGE WITH YOUR WHEEL ORDER.

TECHtip

- Unsecured machines can move, causing grinding breakage and injury. Fixed-based bench and pedestal grinders MUST be secured.
- Do not grind wood, plastic, or any other non-metallic material on a bench or pedestal grinder.
- All bench and pedestal wheels must be dressed to prevent loading. Loading can cause excessive heat, damage to the workpiece, and wheel breakage. Dressing exposes new cutting edges and provides chip clearance.
- Recommended starting dressing stick: 1 x 1 x 6 37C24-SVK Part # 61463610462.



It is the user's responsibility to refer to and comply with ANSI B7.1



CATEGORY DEFINITION

Resin bond, vitrified bond, center lap, and cotton fiber mounted points are available in a wide range of shapes.

- INDUSTRIES:**
- Aerospace
 - Tool and Die
 - Construction
 - Metal Fabrication
 - Automotive
 - Cutlery
 - Mold Shops
 - Stainless Steel Equipment
 - Foundries

ABRASIVE GRAIN: Ceramic Alumina, Zirconia Alumina, Zirconia Alumina/Aluminum Oxide Blend, Aluminum Oxide, Silicon Carbide

SHAPE AVAILABILITY: A, B, and W

MEASUREMENT GUIDE

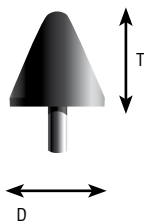
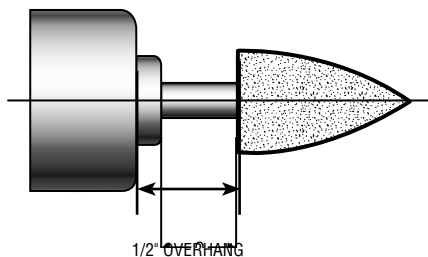

DESCRIPTION OF OVERHANG

Overhang is the distance between the grinder chuck and the abrasive on the spindle. The larger the overhang, the lower the maximum safe operating speed.

SIZE

Measured by diameter (D) x thickness (T)

FEATURED PRODUCTS



COTTON FIBER MOUNTED POINTS

GOOD FOR BLENDING AND POLISHING

FEATURES

- 80 grit
- 120 grit

BENEFITS

- For most materials
- For polishing and stainless steel applications

AVAILABILITY

TIER:	GOOD
BRAND:	Norton
TRADENAME:	COTTON FIBER
ABRASIVE:	Aluminum Oxide

SHAPE	SIZE (D x T)	SPINDLE DIA.†	MAX. RPM*	MIN./STD. PKG.	SPEC	PART #
Cotton Fiber Mounted Points						
A11	7/8 x 2	1/4	19,860	5/25	A80-HBF3	61463622664
B52	3/8 x 3/4	1/8	45,370	5/25	A120-HBF3	61463620242
B121	1/2" Ball	1/8	45,370	5/25	A80-HBF3	61463622657
W163	1/4 x 1/2	1/8	60,000	5/25	A80-HBF3	61463622655
			60,000	5/25	A120-HBF3	61463622656
W176	3/8 x 1/2	1/8	45,370	5/25	A80-HBF3	61463622654
W185	1/2 x 1/2	1/8	34,500	5/25	A80-HBF3	61463622649
W187	1/2 x 1	1/8	20,620	5/25	A80-HBF3	61463622651
W220	1 x 1	1/4	25,500	5/25	A80-HBF3	61463622646

* MAXIMUM RPM VALID TO 1/2" OVERHANG. SEE PACKAGE INSERT FOR OTHER OVERHANGS.

† SPINDLE LENGTH IS 1-1/2"

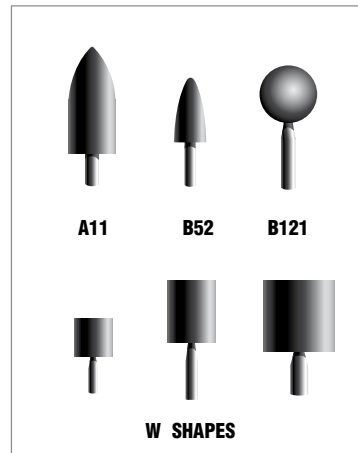



CENTER LAP MOUNTED POINTS
FOR EXCELL-O CENTER LAP AND SIMILAR MACHINES

FEATURES	BENEFITS
■ Specially formulated wheel treatment (#5 wood resin)	■ Adds lubricity to the wheel, minimizing risk of metallurgical damage
■ Larger diameter spindle	■ Minimum deflection, rigid support
■ Precise dimensional tolerances	■ Ensure accurate location of part centers

AVAILABILITY

TIER:	BETTER
BRAND:	Norton
TRADENAME:	CENTER LAP
ABRASIVE:	Aluminum Oxide

SHAPE	SIZE (D x T)	SPINDLE DIA. †	MAX. RPM*	MIN./STD. PKG.	SPEC	PART #
Center Lap Mounted Points						
-	1/2 x 2**	1/2	65,000	5/25	A80-VVM	61463621421
-	1 x 2**	1/2	15,900	5/25	A80-VVM	61463622926

** POINTED 60°
† SPINDLE LENGTH IS 1-1/4"
* MAXIMUM RPM VALID TO 1/2" OVERHANG. SEE PACKAGE INSERT FOR OTHER OVERHANGS.

TECHtip

Dress the center lap mounted points frequently to ensure accurate and smooth center holes.

It is the user's responsibility to refer to and comply with ANSI B7.1



NORTON NORZON – RESIN BOND MOUNTED POINTS
BEST CHOICE FOR FAST STOCK REMOVAL

FEATURES	BENEFITS
■ NZ (NorZon) zirconia alumina self-sharpening abrasive and durable organic bond	■ 2X faster stock removal than competitive aluminum oxide products
	■ Last 4X longer



VENDIBLE

NORTON CHARGER – RESIN BOND MOUNTED POINTS
BETTER CHOICE FOR FAST STOCK REMOVAL AND LONG LIFE

FEATURES	BENEFITS
■ Zirconia alumina/aluminum oxide abrasive blend	■ 35% faster cut rate than standard aluminum oxide
	■ An aggressive, free cut
	■ More parts cleaned in less time to substantially increase productivity
■ Specially formulated organic bond	■ 2X greater life than ordinary aluminum oxide
	■ Reduces vibration and wheel chatter
■ NEW! Charger mounted point pre-packed in small packages	■ Ideal for vending machines, pegboards, small jobs, and carrying to job site

AVAILABILITY

TIER:	BEST	BETTER
BRAND:	Norton	Norton
TRADENAME:	NORZON	CHARGER
ABRASIVE:	Zirconia Alumina	Zirconia Alumina/Aluminum Oxide

SHAPE	SIZE (D x T)	SPINDLE DIA. †	MAX. RPM*	MIN./STD. PKG.	SPEC	PART #	SPEC	PART #
Resin Bond Mounted Points								
A1	3/4 x 2-1/2	1/4	19,800	5/25	NZ24-UBXR1	61463616457	Charger	61463616458
			19,800	4	✓		Charger	66253325922
A3	1 x 2-3/4	1/4	16,100	5/25	NZ24-UBXR1	61463616459	Charger	61463616460
			16,100	2	✓		Charger	66253325924
A5	3/4 x 1-1/8	1/4	45,000	5/25			Charger	61463616462
			45,000	5	✓		Charger	66253325926
A11	7/8 x 2	1/4	19,860	5/25	NZ24-UBXR1	61463616463	Charger	61463616464
W189	1/2 x 2	1/4	24,000	5/25	NZ24-UBXR1	61463616465	Charger	61463616466
			24,000	5	✓		Charger	66253325928
W197	5/8 x 2	1/4	21,000	5/25	NZ24-UBXR1	61463616467		
W207	3/4 x 1-1/2	1/4	24,000	5/25			Charger	61463616470
W208	3/4 x 2	1/4	18,750	5/25	NZ24-UBXR1	61463616471	Charger	61463616472
W220	1 x 1	1/4	25,500	5/25	NZ24-UBXR1	61463617520	Charger	61463617521
			25,500	5	✓		Charger	66253325930
W221	1 x 1-1/2	1/4	19,120	5/25	NZ24-UBXR1	61463616473	Charger	61463616474
W222	1 x 2	1/4	15,900	5/25	NZ24-UBXR1	61463616475	Charger	61463616476

† SPINDLE LENGTH IS 1-1/2"
* MAXIMUM RPM VALID TO 1/2" OVERHANG. SEE PACKAGE INSERT FOR OTHER OVERHANGS.
✓ = VENDIBLE PACKAGE. IDEAL FOR VENDING MACHINES AND SMALL JOBS. MIN. PKG. QTY = NUMBER OF MOUNTED POINTS PER VENDIBLE PACK. ORDER IN MULTIPLES OF MIN QTY.

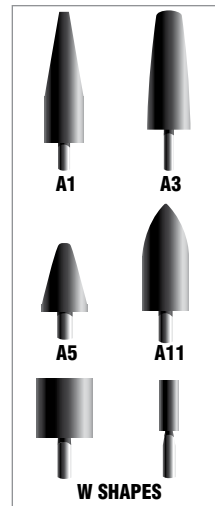



NORTON QUANTUM – VITRIFIED BOND MOUNTED POINTS

BEST CHOICE FOR HIGH VOLUME OPERATIONS

FEATURES

- Unique, engineered ceramic grain shape and chemistry with proven bond technology
- Oil and Gas 36 grit mounted points

BENEFITS

- Ideal for high-volume foundry operations – grinding Inconel and similar alloy turbine blade components
- Minimal loading and heat build-up
- 33% + longer life versus competitive ceramic products
- 30% + higher metal removal rates
- Versatile, optimized for all low-, medium- and high-force applications
- Exceptional productivity and life
- Specifically engineered to efficiently grind the carbide matrix material of oilfield drill heads



NORTON GEMINI – VITRIFIED BOND MOUNTED POINTS

GOOD VALUE FOR GENERAL PURPOSE, SMALL JOB SHOP APPLICATIONS

FEATURES

- 38A abrasive
- Diverse shapes and sizes

BENEFITS

- Cool cutting, less burn
- Ideal when initial price is the main purchasing consideration

AVAILABILITY

TIER:	BEST	GOOD
BRAND:	Norton	Norton
TRADENAME:	QUANTUM	GEMINI
ABRASIVE:	Ceramic Alumina	38A

SHAPE	SIZE (D x T)	SPINDLE DIA.†	MAX. RPM*	MIN./STD. PKG.	SPEC	PART #	SPEC	PART #
Vitrified Bond Mounted Points – A Shapes								
A1	3/4 x 2-1/2	1/4	19,800	25/250	Oil & Gas 36	61463686139		
A1	3/4 x 2-1/2	1/4	19,800	5/25	3NQ80	69083149139	38A36-T	61463624374
A1	3/4 x 2-1/2	1/4	19,800	5/25			38A60-P	61463624375
A3	1 x 2-3/4	1/4	16,100	25/250	Oil & Gas 36	61463686138		
A3	1 x 2-3/4	1/4	16,100	5/25	3NQ80	69083160166	38A36-T	61463624377
A3	1 x 2-3/4	1/4	16,100	5/25			38A60-P	61463624378
A4	1-1/4 x 1-1/4	1/4	30,560	5/25			38A60-P	61463624380
A5	3/4 x 1-1/8	1/4	45,000	5/25	3NQ80	69083149140	38A36-T	61463624381
A5	3/4 x 1-1/8	1/4	45,000	5/25			38A60-P	61463624382
A11	7/8 x 2	1/4	19,860	5/25	3NQ80	69083149141	38A36-T	61463624384
A11	7/8 x 2	1/4	19,860	5/25			38A60-P	61463624385
A12	11/16 x 1-1/4	1/4	48,000	5/25	3NQ60	61463677679	38A60-P	61463624388
A13	1-1/8 x 1-1/8	1/4	33,950	5/25			38A60-P	61463624389
A14	11/16 x 7/8	1/4	55,560	5/25			38A60-P	61463624390
A15	1/4 x 1-1/16	1/4	72,750	5/25			38A60-P	61463624391
A21	1 x 1	1/4	34,500	5/25	3NQ80	69083149144	38A60-P	61463624392
A23	3/4 x 1	1/4	39,370	5/25	3NQ80	69083149143	38A60-P	61463624394
A24	1/4 x 3/4	1/4	76,500	5/25			38A60-P	61463624395
A25	1" Ball	1/4	35,620	5/25	3NQ80	61463677680	38A60-P	61463624396
A26	5/8" Ball	1/4	61,120	5/25	3NQ80	69083149145	38A60-P	61463624397
A31	1-3/8 x 1	1/4	27,780	5/25			38A60-P	61463624399
A34	1-1/2 x 3/8	1/4	25,470	5/25			38A60-P	61463624402
A36	1-5/8 x 3/8	1/4	23,520	25/250	Oil & Gas 36	66253145562		
A36	1-5/8 x 3/8	1/4	23,520	5/25	3NQ80	69083149146	38A60-P	61463624404
A37	1-1/4 x 1/4	1/4	30,560	5/25			38A60-P	61463624405
A38	1 x 1	1/4	34,500	5/25	3NQ80	61463677682	38A60-P	61463624406
A39	3/4 x 3/4	1/4	47,250	5/25	3NQ80	69083149147	38A60-P	61463624407
A40	3/4" Ball	1/4	47,250	5/25			38A60-P	61463624408

† STANDARD SPINDLE SIZE IS 1/4" X 1-1/2"
 * MAXIMUM RPM VALID TO 1/2" OVERHANG. SEE PACKAGE INSERT FOR OTHER OVERHANGS.

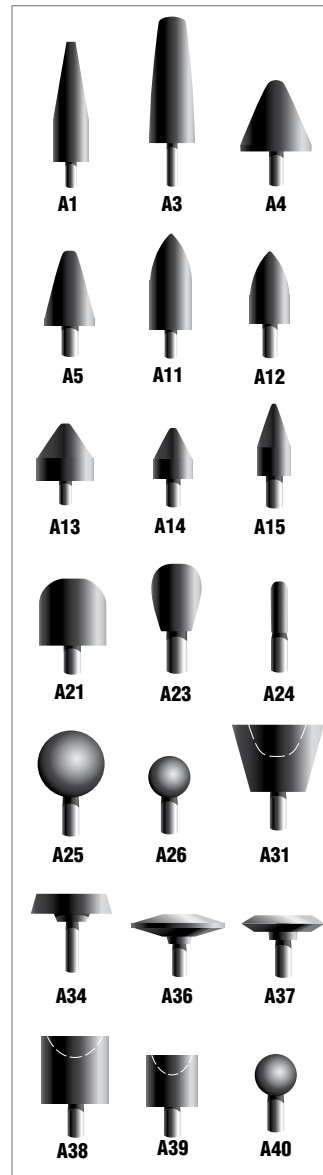



AVAILABILITY

TIER:	BEST	GOOD
BRAND:	Norton	Norton
TRADENAME:	QUANTUM	GEMINI
ABRASIVE:	Ceramic Alumina	38A

SHAPE	SIZE (D x T)	SPINDLE DIA. †	MAX. RPM*	MIN./STD. PKG.	SPEC	PART #	SPEC	PART #
Vitrified Bond Mounted Points – B Shapes								
B41	5/8 x 5/8	1/8	33,570	5/25			38A60-P	61463624410
B42	1/2 X 3/4	1/8	33,570	5/25	3NQ80	69083149045	38A60-P	61463624412
B43	1/4 x 5/16	1/8	81,370	5/25			38A60-P	61463624413
B44	7/32 x 3/8	1/8	68,400	5/25			38A60-P	61463624414
B45	3/16 x 5/16	1/8	104,250	5/25			38A60-P	61463624415
B46	1/8 x 5/16	1/8	105,000	5/25			38A60-P	61463624416
B51	7/16 x 3/4	1/8	45,370	5/25			38A60-P	61463624418
B52	3/8 x 3/4	1/8	45,370	5/25	3NQ80	69083149046	38A60-P	61463624420
B52	3/8 x 3/4	1/4	81,000	5/25			38A60-P	61463624419
B52	3/8 x 3/4	1/8	45,370	5/25			38A90-Q	61463624422
B53	5/16 x 5/8	1/8	60,000	5/25			38A60-P	61463624423
B54	1/4 x 1/2	1/8	60,000	5/25			38A60-P	61463624424
B55	1/8 x 1/4	1/8	105,000	5/25			38A60-P	61463624425
B81	3/4 x 3/16	1/8	50,930	5/25			38A60-P	61463624437
B91	1/2 x 5/8	1/8	34,500	5/25			38A60-P	61463624443
B96	1/8 x 1/4	1/8	105,000	5/25			38A60-P	61463624448
B96	1/8 x 1/4	1/8	105,000	5/25			38A90-Q	61463624449
B97	1/8 x 3/8	1/8	105,000	5/25	3NQ80	69083149048	38A60-P	61463624451
B98	3/32 x 1/4	1/8	105,000	5/25			38A60-P	61463624452
B121	1/2" Ball	1/8	45,370	5/25			38A60-P	61463624466
B122	3/8" Ball	1/8	61,650	5/25	3NQ80	69083149050	38A60-P	61463624470
B122	3/8" Ball	1/8	61,650	5/25			38A90-Q	61463624471
B123	3/16" Ball	1/8	104,250	5/25			38A60-P	61463624472
B124	1/8" Ball	1/8	105,000	5/25			38A90-Q	61463624474
B131	1/2 x 1/2	1/8	34,500	5/25	3NQ80	69083149049	38A60-P	61463624475
B132	3/8 x 1/2	1/8	45,370	5/25			38A60-P	61463624479
B133	3/8 x 3/8	1/8	54,000	5/25			38A60-P	61463624481
B134	5/16 x 3/8	1/8	61,650	5/25			38A60-P	61463624482
B135	1/4 x 1/2	1/8	60,000	5/25			38A60-P	61463624484
B136	1/4 x 5/16	1/8	77,250	5/25			38A60-P	61463624485

† STANDARD SPINDLE SIZE IS 1/8" OR 1/4" X 1-1/2"
 * MAXIMUM RPM VALID TO 1/2" OVERHANG. SEE PACKAGE INSERT FOR OTHER OVERHANGS.

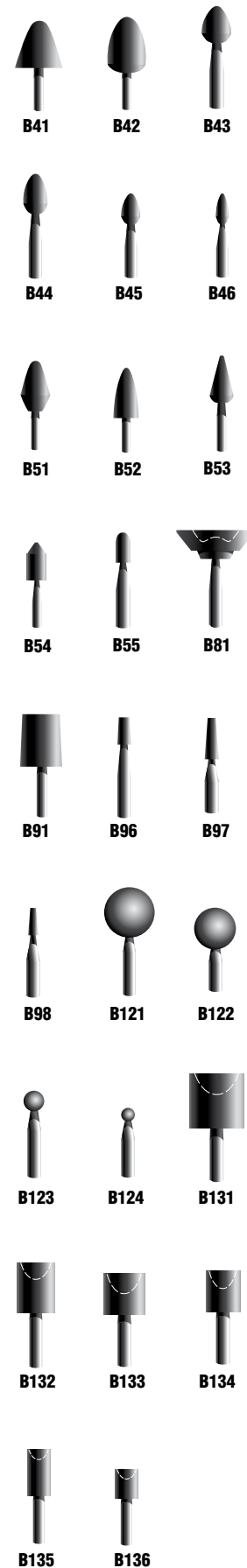



AVAILABILITY

TIER:	BEST	GOOD
BRAND:	Norton	Norton
TRADENAME:	QUANTUM	GEMINI
ABRASIVE:	Ceramic Alumina	38A

SHAPE	SIZE (D x T)	SPINDLE DIA. †	MAX. RPM*	MIN./STD. PKG.	SPEC	PART #	SPEC	PART #
Vitrified Bond Mounted Points – W Shapes								
W144	1/8 x 1/4	1/8	105,000	5/25			38A60-P	61463624488
W145	1/8 x 3/8	1/8	105,000	5/25			38A60-P	61463624489
W146	1/8 x 1/2	1/8	105,000	5/25			38A60-P	61463624491
W152	3/16 x 1/4	1/8	105,000	5/25			38A60-P	61463624495
W153	3/16 x 3/8	1/8	80,850	5/25			38A60-P	61463624496
W154	3/16 x 1/2	1/8	70,500	5/25	3NQ80	69083149133	38A60-P	61463624497
W160	1/4 x 1/4	1/8	81,370	5/25			38A60-P	61463624501
W162	1/4 x 3/8	1/8	64,800	5/25			38A60-P	61463624503
W163	1/4 x 1/2	1/8	60,000	5/25			38A60-P	61463624504
W164	1/4 x 3/4	1/8	45,900	5/25	3NQ80	69083149135	38A60-P	61463624505
W170	5/16 x 1/2	1/8	52,500	5/25			38A60-P	61463624511
W175	3/8 x 3/8	1/8	54,000	5/25			38A60-P	61463624516
W176	3/8 x 1/2	1/8	45,370	5/25			38A60-P	61463624517
W177	3/8 x 3/4	1/8	33,750	5/25			38A60-P	61463624518
W179	3/8 x 1-1/4	1/4	20,415	25/250	Oil & Gas 36	69083154055		
W185	1/2 x 1/2	1/8	34,500	5/25	3NQ80	69083149137	38A60-P	61463624525
W185	1/2 x 1/2	1/4	61,500	5/25			38A60-P	61463624526
W186	1/2 X 3/4	1/4	51,000	5/25			38A60-P	61463624528
W188	1/2 x 1-1/2	1/4	30,370	5/25			38A60-P	61463624530
W189	1/2 x 2	1/4	24,000	25/250	Oil & Gas 36	61463686137		
W189	1/2 x 2	1/4	24,000	5/25	3NQ80	61463677683	38A60-P	61463624531
W196	5/8 x 1	1/4	35,250	5/25			38A60-P	61463624539
W200	3/4 x 1/8	1/8	50,930	5/25			38A60-P	61463624543
W200	3/4 x 1/8	1/8	50,930	5/25			38A90-Q	61463624544
W204	3/4 x 3/4	1/4	42,750	5/25			38A60-P	61463624549
W205	3/4 x 1	1/4	34,500	5/25			38A60-P	61463624550
W208	3/4 x 2	1/4	18,750	5/25	3NQ80	61463677684	38A60-P	61463624553
W215	1 x 1/8	1/8	38,200	5/25	3NQ80	69083149138	38A60-P	61463624560
W216	1 x 1/4	1/4	38,200	5/25			38A60-P	61463624562
W218	1 x 1/2	1/4	38,200	25/250	Oil & Gas 36	69083154061		
W218	1 x 1/2	1/4	38,200	5/25			38A60-P	61463624564
W220	1 x 1	1/4	25,500	5/25	3NQ80	61463677685	38A60-P	61463624566
W221	1 x 1-1/2	1/4	19,120	5/25			38A60-P	61463624567
W222	1 x 2	1/4	15,900	5/25			38A60-P	61463624569
W230	1-1/4 x 1-1/4	1/4	20,400	5/25			38A60-P	61463624578
W235	1-1/2 x 1/4	1/4	25,470	5/25			38A60-P	61463624583
W236	1-1/2 x 1/2	1/4	25,470	5/25	3NQ80	61463677686	38A60-P	61463624585
W237	1-1/2 x 1	1/4	22,500	5/25			38A60-P	61463624587
W238	1-1/2 x 1-1/2	1/4	15,600	5/25			38A60-P	61463624588
W242	2 x 1	1/4	19,100	5/25	3NQ80	69083149148	38A60-P	61463624592

† STANDARD SPINDLE SIZE IS 1/8" OR 1/4" X 1-1/2" * MAXIMUM RPM VALID TO 1/2" OVERHANG. SEE PACKAGE INSERT FOR OTHER OVERHANGS.

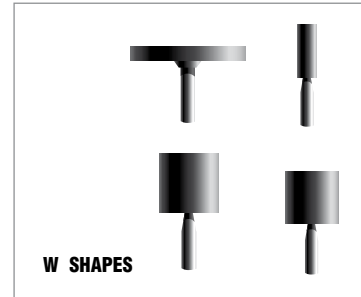

TECHtip

- For best mounted point performance, always run the mounted point at the maximum allowable speed according to ANSI B7.1. Refer to the speed chart included in each shipment for proper operating speeds.
- Use "A" shapes for medium- to heavy-duty blending.
- Use "B" shapes for light deburring and finishing/polishing.
- Use "W" shapes for offhand and precision grinding of medium to heavy stock.
- Use 36 grit and coarser for rough grinding.
- Use 60 and 90 grits for imparting fine finishes or when grinding on narrow surfaces.



It is the user's responsibility to refer to and comply with ANSI B7.1



50-Piece Mounted Point Kits

- Each kit contains 5 each of 10 of our best selling mounted point shapes and specifications
- The 1/4" spindle kits contain "A"-shaped points that are ideal for general maintenance and metalworking applications
- The 1/8" spindle kits contain "B"-shaped points for light deburring machine parts or finishing/polishing dies
- The "W"-shaped points in all of these kits work well for precision grinding of medium to heavy stock

TIER:	BEST	GOOD
BRAND:	Norton	Norton
TRADE NAME:	QUANTUM	GEMINI

SHAPE	SPINDLE DIA. †	MIN./STD. PKG.	PART #	PART #
Mounted Point Kits				
Assorted	1/4	1	50 piece Premium Norton Quantum 1/4" Spindle Mounted Point Kit contains 5 each of Norton Quantum A1, A5, A11, A21, A23, A26, A36, A39, W242, and A80-HBF3 W220	69083147810
Assorted	1/8	1	50 piece Premium Norton Quantum 1/8" Spindle Mounted Point Kit contains 5 each of Norton Quantum B42, B52, B97, B122, B131, W154, W164, W185, W215, and A80-HBF3 W163	69083147806
Assorted	1/4	1	50 piece Norton Gemini 1/4" Spindle Mounted Point Kit contains 5 each of 38A60-P A1, A5, A11, A21, A23, A26, A36, A39, W242, and A80-HBF3 W220	69083147789
Assorted	1/8	1	50 piece Norton Gemini 1/8" Spindle Mounted Point Kit contains 5 each of 38A60-P B42, B52, B97, B122, B131, W154, W164, W185, W215, and A80-HBF3 W163	69083147669

† STANDARD SPINDLE SIZE IS 1/8" OR 1/4" X 1-1/2"



CATEGORY DEFINITION

Since 1823, Norton has been the leading supplier of conventional and diamond benchstones, waterstones, sharpening systems, files, slips and specialty stones for industrial, commercial and DIY sharpening applications. Our comprehensive line of sharpening and finishing products is the industry's broadest line with premier performance and quality.

- APPLICATIONS:** Deburring, dimensioning, sharpening, honing
- GRIT RANGE:** Coarse, Medium, Fine, Extra Fine, Ultra Fine
- ABRASIVE TYPES:** Aluminum Oxide (India) , Silicon Carbide (Crystonol) , Arkansas (Soft and Hard Translucent), and Diamond

APPLICATION-TO-PRODUCT RECOMMENDATION GUIDE

Benchstones

	Coarse/Medium Sharpening	Fine Stoning	Finish Honing
Chip Breakers	-	Fine Crystolon Benchstone	-
Draw Knives	Coarse Crystolon Benchstone	Fine India Benchstone	Hard Arkansas Benchstone
Scrapers	Coarse Crystolon Benchstone	Fine India Benchstone	Hard Arkansas Benchstone
Chisels (Wood)	Coarse Crystolon Benchstone 1000 Waterstone	Fine India Benchstone 4000 Waterstone	Hard Arkansas Benchstone 8000 Waterstone
Plane Blades	Coarse Crystolon Benchstone 1000 Waterstone	Fine India Benchstone 4000 Waterstone	Hard Arkansas Benchstone 8000 Waterstone

Slips

	Coarse/Medium Sharpening	Fine Stoning
Milling Cutter	Medium India Round Edge Slip	Fine India Round Edge Slip
Carbide Tools		Fine Crystolon Slip for Carbide Tools

Abrasive Files

	Coarse/Medium Sharpening	Fine Stoning	Finish Honing
Form Cutter	Coarse or Medium India Knife Blade	Fine India Knife Blade	-
Keyways	Coarse or Medium India Square File	Fine India Square File	-
Lathe Bits	Medium India Square File	Fine India Square File	-
Radius Tools	Medium India Round File	Fine India Round File	-
Reamers	Medium India Reamer Stone	Fine India Reamer Stone	-
Router Bits	-	Fine India Square File	-
Saws	Coarse India Triangular File	Fine India Tapered Triangular File	-
Center Punches	Medium India Triangular File	Fine India Triangular File	-
Magnetic Chucks	Medium Crystolon Round File	Fine India Round File	-
Molding Cutters*	Coarse or Medium India File	Fine India File	-
Countersinks	Coarse India Triangular File	Fine India Triangular File	Hard Arkansas Triangular File
Tap Threads	-	Fine India Triangular File	-

* SELECT SHAPE TO FIT CONFIGURATION



Relative Sharpening Comparisons for Norton Products

CRYSTOLON (SILICON CARBIDE) INDIA (ALUMINUM OXIDE)	ARKANSAS (SOFT, HARD TRANSLUCENT)	DIAMOND STONES	WATERSTONES			DIAMOND COMPOUND
			JIS (JAPAN)	CAMI (USA)	FIPA (EUROPE)	
Coarse Crystolon					P100	141
					P120	127
						116
Coarse India					P150	97
						93
Medium Crystolon		Extra Coarse Diamond (220)	Norton 220		180	78
					P220	65
						60
Medium India					P240	58
						53.5
					P280	52.5
Fine Crystolon		Coarse Diamond (325)				50
						46
						45
Fine India					280	43
						40.5
					360	36
					P360	36
						35
						29
					P400	25.8
						23
						22
	Soft Arkansas	Fine Diamond (600)			600	20
						16
						14
					800	14.6
					Norton 1000	14
						11
					1200	10.3
						9.2
						9
					1500	8.4
						7.5
						6
	Hard Translucent Arkansas		Norton 4000	2000		5
						3
					Norton 8000	1.2
						1
						0.5
					15000	

FEATURED PRODUCTS

Benchstones



PRECISION BENCHSTONES

BETTER CHOICE FOR SHARPENING TOOLS AND KNIVES

FEATURES AND APPLICATIONS

- Jewelers' Benchstones – These stones are excellent for sharpening the fine, precision cutting tools used by jewelers, engravers and artisans.
- Penknife Precision Benchstones – Ideal for sharpening cutting tools, laboratory blades, surgical instruments, engravers' and die makers' tools, and pocket knives to the keenest edge.

AVAILABILITY

TIER: **BETTER**

SIZE (L x W x H)	QTY./ PKG.	QTY./ CASE	SPEC.	PRODUCT #	PART #
Precision Benchstones – Jewelers'					
4 x 2 x 3/8	1	5	Ultra Fine – Hard Translucent Arkansas	HB24	61463687525
6 x 2 x 3/8	1	5	Ultra Fine – Hard Translucent Arkansas	HB26	61463687530
Precision Benchstones – Penknife					
3 x 1 x 3/8	5	10	Extra Fine – Soft Arkansas	SB13	61463687560
			Ultra Fine – Hard Translucent Arkansas	HB13	61463687550
4 x 1 x 3/8	5	10	Extra Fine – Soft Arkansas	SB14	61463687565
			Ultra Fine – Hard Translucent Arkansas	HB14	61463687555



Benchstones CONTINUED

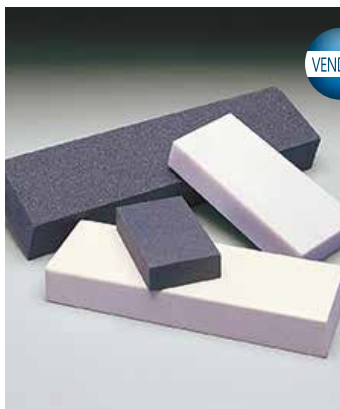

VENDIBLE

SINGLE GRIT ABRASIVE BENCHSTONES
BETTER CHOICE FOR EDGE SHAPING AND HONING

FEATURES

- Crystolon – Premium silicon carbide abrasive
- India – Smooth cutting aluminum oxide abrasive; our best product for a fine finish
- Arkansas – Natural premium Novaculite quarried in Arkansas and available in Soft or Hard Translucent

BENEFITS

- Fast cutting stone; ideal for general sharpening of cutting tools
- Fast stock removal for quick edge shaping with minimal loading
- Long lasting cutting edge
- The choice of artisans, craftsmen and mechanics
- Ideal for clean deburring, generating keen edges and quality finishes
- Sharpest possible razor edges
- Near mirror finishes
- Use for finer honing after India stone

AVAILABILITY

TIER: **BETTER**

SIZE (L x W x H)	QTY./ PKG.	QTY./ CASE	SPEC.	PRODUCT #	PART #
Single Grit Benchstones – Crystolon (Silicon Carbide)					
4 x 1 x 1/4	1	5	Coarse	CJB14	61463685470
	1	5	Medium	MJB14	61463685465
	1	5	Fine	FJB14	61463685460
	5	5	Fine	FJB14-V	66253325915+
4 x 1 x 1/2	1	5	Coarse	CJB24	61463685485
	1	5	Medium	MJB24	61463685480
	1	5	Fine	FJB24	61463685475
5 x 2 x 5/8	1	5	Medium	MJB35	61463685495
	1	5	Fine	FJB35	61463685490
6 x 2 x 1	1	5	Coarse	CJB6	61463685510
	1	5	Medium	MJB6	61463685505
	1	5	Fine	FJB6	61463685500
8 x 2 x 1	1	5	Coarse	CJB8	61463685525
	1	5	Medium	MJB8	61463685520
	1	5	Fine	FJB8	61463685515
8 x 3 x 1/2	5	5	Coarse	CJB83-V	61463654459*
	5	5	Medium	MJB83-V	61463654458*
	5	5	Fine	FJB83-V	61463654457*
11-1/2 x 2-1/2 x 1/2	1	1	Coarse	JM3	61463685980#
	1	1	Medium	JM6	61463685975#
Single Grit Benchstones – Soft Arkansas					
4 x 2 x 3/4-1	1	5	Extra Fine	SB4	61463685670
6 x 2 x 3/4-1	1	5	Extra Fine	SB6	61463685675
8 x 2 x 3/4-1	1	5	Extra Fine	SB8	61463685680

V = VENDIBLE PACKAGE. IDEAL FOR VENDING MACHINES, SMALL JOBS, AND CARRYING TO JOB SITE. PRE-PACKED IN STURDY BOXES OF 5 PER PACK. ORDER BY TOTAL NUMBER OF STONES NEEDED; NOT BY QUANTITY OF PACKS.

* MAY BE USED AS REPLACEMENT STONE FOR IM-83 SHARPENING SYSTEM.

MAY BE USED AS REPLACEMENT STONE FOR IM-313 SHARPENING STONE SYSTEM.

AVAILABILITY

TIER: **BETTER**

SIZE (L x W x H)	QTY./ PKG.	QTY./ CASE	SPEC.	PRODUCT #	PART #
Single Grit Benchstones – India (Aluminum Oxide)					
4 x 1 x 1/4	1	5	Coarse	CB14	61463685580
	1	5	Medium	MB14	61463685575
	1	5	Fine	FB14	61463685570
	5	5	Fine	FB14-V	66253325919
4 x 1 x 1/2	1	5	Coarse	CB24	61463685595
	1	5	Medium	MB24	61463685590
	1	5	Fine	FB24	61463685585
5 x 2 x 5/8	1	5	Medium	MB35	61463685605
	1	5	Fine	FB35	61463685600
6 x 2 x 1	1	5	Coarse	CB6	61463685620
	1	5	Medium	MB6	61463685615
	1	5	Fine	FB6	61463685610
8 x 2 x 1	1	5	Coarse	CB8	61463685635
	1	5	Medium	MB8	61463685630
	1	5	Fine	FB8	61463685625
8 x 3 x 1/2	5	5	Coarse	CB83-V	61463654462*
	5	5	Medium	MB83-V	61463654461*
	5	5	Fine	FB83-V	61463654460*
11-1/2 x 2-1/2 x 1/2	1	1	Coarse	IM6	61463654214#
	1	1	Medium	IM9	61463685970#
Single Grit Benchstones – Hard Translucent Arkansas					
4 x 2 x 3/4-1	1	5	Ultra Fine	HB4	61463685655
6 x 2 x 3/4-1	1	5	Ultra Fine	HB6	61463685660
8 x 2 x 3/4-1	1	5	Ultra Fine	HB8	61463685665
8 x 3 x 1/2	5	5	Ultra Fine	HTB83-V	61463654464*
11-1/2 x 2-1/2 x 1/2	1	1	Ultra Fine	HM11	61463685965#



Benchstones CONTINUED



COMBINATION GRIT ABRASIVE BENCHSTONES

BETTER CHOICE FOR ECONOMICAL SOLUTION FOR GENERAL SHARPENING AND FINISHING WITH ONE STONE

FEATURES AND APPLICATIONS

- **Crystolon Combination**
Coarse and fine grit sharp-cutting silicon carbide abrasive surfaces for general sharpening (to moderate tolerances) when the speed of sharpening is more important than the fineness of the cutting edges. Gray in color.
- **India Combination**
Coarse and fine grit aluminum oxide abrasive surfaces produce strong, keen, long-lasting edges on quality tools. Orange/brown in color.
- **Crystolon/India Combination**
Fast-sharpening, medium grit silicon carbide (Crystolon) and fine aluminum oxide (India) abrasive surfaces for keen, long-lasting edges on quality tools. Crystolon side is dark gray in color, India side is orange.
- **Giant Combination Stones**
11-1/2" and 12" bench oil stones are used to sharpen large edge tools with long sweeping strokes.

AVAILABILITY

SIZE (L x W x H)	QTY./ PKG.	QTY./ CASE	SPEC.	TIER: BETTER	
				PRODUCT #	PART #
Combination Grit Benchstones – Crystolon (Silicon Carbide)					
4 x 1 Round	1	5	Coarse/Fine	JB64	61463685435
4 x 1-3/4 x 5/8	1	5	Coarse/Fine	JB134	61463685440
5 x 2 x 3/4	1	5	Coarse/Fine	JB45	61463685445
6 x 2 x 1	1	5	Coarse/Fine with Anniversary Box	JB6	61463685450
8 x 2 x 1	1	5	Coarse/Fine with Anniversary Box	JB8	61463685455
11-1/2 x 2-1/2 x 1	1	2	Coarse/Fine	JUM3	61463685840
12 x 2-1/2 x 1-1/2	1	2	Coarse/Fine	JUM4	61463685855
Combination Grit Benchstones – India (Aluminum Oxide)					
4 x 1 Round	1	5	Coarse/Fine	IB64	61463685545
4 x 1-3/4 x 5/8	1	5	Coarse/Fine	IB134	61463685550
5 x 2 x 3/4	1	5	Coarse/Fine	IB45	61463685555
6 x 2 x 1	1	5	Coarse/Fine with Anniversary Box	IB6	61463685560
8 x 2 x 1	1	5	Coarse/Fine with Anniversary Box	IB8	61463685565
11-1/2 x 2-1/2 x 1	1	2	Coarse/Fine	IM2	61463685851
Combination Grit Benchstones – Crystolon/India					
6 x 2 x 1	1	5	Medium/Fine	IC6	61463685643
11-1/2 x 2 x 1	1	2	Medium/Fine	IC11	61463687239
Oil Stone Instructional Dvd					
N/A	1	1	Oil Stone DVD		07660787945

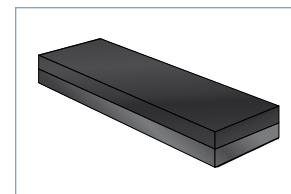

APPLICATION-TO-PRODUCT RECOMMENDATION GUIDE

	FAST CUT STOCK REMOVAL	INITIAL SHARPENING	FINAL SHARPENING	HONING	SHARPEST EDGE
Grit Size	Coarse	Medium	Fine	Extra Fine	Ultra Fine
Abrasive	Crystolon	Crystolon	India	Soft Arkansas	Hard Arkansas
Product/Color	Grey	Grey	Orange	Milky White	Translucent



Instructional DVD Offering

Waterstone: 07660787944
Oil Stone: 07660787945

Ideal for sales training and end-user self-study. Learn to efficiently use these sharpening products to maintain tools at peak performance and prolong their life – to make all your sharpening, honing, etc. applications easier.



Waterstones

Waterstones are synthetic stones designed to be softer than oil stones. These softer grade stones are used with water as the lubricant (versus oil) to develop a fast cutting slurry. The Norton Waterstone system was designed in a carefully planned sequence to create sharpening efficiency. You get the level of abrasiveness you need at each stage, without wasting time trying to sharpen your tools on a grit that is too fine, too soon.



WATERSTONES

BETTER CHOICE FOR PRODUCING SUPERIOR EDGES ON PLANES AND STRAIGHT CHISELS

FEATURES

- System of four synthetic “Japanese-type” stones designed to work together, with water
- Softer than traditional oilstones – providing lapping action
- Color-coded by grit

BENEFITS

- Fast sharpening, fine finish
- Superb results with low pressure
- Easy to differentiate grit size



PREP STONE

BETTER CHOICE FOR RAISING SLURRY

FEATURES

- This synthetic stone raises the slurry

BENEFITS

- Speeds up the slurry-making process needed to cut and polish with waterstones

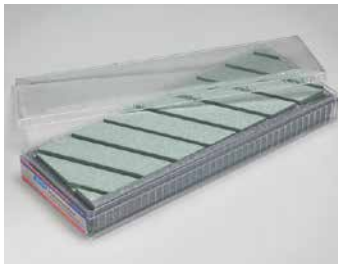

FLATTENING STONE

BETTER CHOICE FOR PRODUCING FLAT SURFACES ON WATERSTONES

FEATURES

- Coarse grit silicon carbide stone
- Diagonal grooves
- Superbly flat with hard bond

BENEFITS

- Promotes maximum cutting for all grit sizes of waterstones
- Provide swarf removal
- Produces extremely flat results on all waterstones

AVAILABILITY

TIER: **BETTER**

SIZE (L x W x H)	QTY./ PKG.	QTY./ CASE	SPEC.	PART #
Waterstones – Single Grit (Bulk-Packed)				
8 x 3 x 1	1	5	220	61463689505
	1	5	1000	61463689506
	1	5	4000	61463689507
	1	5	8000	61463689508
Set	1	1	4 Stones: 220, 1000, 4000, 8000 Grit	61463624334
Waterstones – Combination Grit (Bulk-Packed)				
8 x 3 x 1	1	5	220 / 1000	61463624335
	1	5	1000 / 4000	61463624450
	1	5	1000 / 8000	69936655039
	1	5	4000 / 8000	61463624336
Prep Stone				
20mm x 20mm x 3"	1	5	Aluminum Oxide	66243439361
Flattening Stone				
9 x 3 x 3/4	1	5	Silicon Carbide	69936687444
Waterstone Kit				
N/A	1	1	Kit includes: 1-220/1000 and 1-4000/8000 waterstone, 1 flattening stone and 1 instructional DVD	07660787943
Waterstone Instructional DVD				
N/A	1	1	Waterstone DVD	07660787944

TECHtip

MAXIMIZING WATERSTONE PERFORMANCE

- Wet waterstone
- Rub evenly with the prep stone to create slurry
- Evening off the high spots will make for less-frequent flattening of the waterstones
- Waterstones wear concave with use; periodically flatten with flattening stone



Diamond Benchstones

Made in the USA, these benchstones have unique stackable non-skid rubber feet designed to keep the diamond plate steady while you sharpen, and efficiently stacked for space-saving storage when not in use. Our simple grit-size color-coding makes them easy to differentiate.

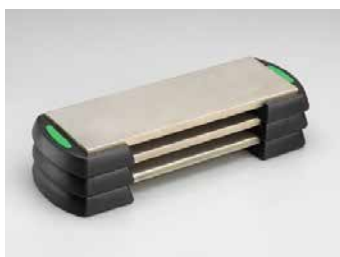

STACKABLE DIAMOND BENCHSTONES

BETTER CHOICE FOR PRODUCING SUPERIOR EDGES ON PLANES AND STRAIGHT CHISELS

FEATURES	BENEFITS
■ Made in the USA	■ Quality industrial diamonds and workmanship
■ Flat, diamond surface plated onto a nickel-coated steel bar precision ground to a tolerance of .001"	■ Fast, even blade and tool edge sharpening
■ Even diamond distribution; continuous diamond sharpening surface	■ Easily lubricated with water, but oil may be used
■ Available in 3 grit sizes: 220 (red), 325 (blue), 600 (green), and 2 sizes: 6" and 8"	■ Excellent sharpening performance across entire surface of stone
■ Color-coded tabs on stones and packaging	■ Quicker sharpening than conventional interrupted-surface diamond stones
■ Stackable; the stones firmly stack on top of each other	■ Pointed tools will not snag, as on interrupted-surface diamond stones
■ Non-skid rubber base	■ Ideal for all your large and small tool sharpening and finishing needs
	■ Easy identification of grit sizes for use and displaying
	■ Easy, small-profile storage
	■ Stays in place while sharpening for smoother, efficient sharpening

AVAILABILITY

		TIER:		BETTER	
SIZE WITH RUBBER FEET (L x W x H)	QTY./PKG.	QTY./CASE	SPEC.	PRODUCT #	PART #
Stackable Diamond Benchstones					
6 x 2 x 1/4*	1	5	D220		66253268082
6 x 2 x 1/4*	1	5	D325		66253268081
6 x 2 x 1/4*	1	5	D600		66253268080
8 x 2 x 1/4	1	5	D220		66253268087
8 x 2 x 1/4	1	5	D325		66253268086
8 x 2 x 1/4	1	5	D600		66253268083



6" STONES COME RETAIL PACKAGED

Sharpening Stone Oil



SHARPENING STONE OIL

BETTER CHOICE FOR IMPROVING SHARPENING STONE PERFORMANCE

FEATURES	BENEFITS
■ Norton oil is a highly refined lubricating oil	■ Specifically formulated for sharpening stone use
■ Meets U.S. Pharmacopoeia standards for mineral oil purity	■ Equally ideal for all lubricating jobs
	■ It will not load or "gum-up" sharpening stones
	■ May be used around food preparation operations

AVAILABILITY

		TIER:		BETTER	
SIZE	QTY./PKG.	QTY./CASE	SPEC.	PRODUCT #	PART #
Sharpening Stone Oil					
4-1/2 oz.	1	20	Oil	XB1	61463687760
1 Pint	1	20	Oil	XB5	61463687770
1 Quart	1	5	Oil	XB2	61463687775

TECHtip

- All oil stones are porous in nature; oil is required to keep the pores open and working efficiently
- Use Norton oil to optimize the performance of Crystolon, India and Arkansas stones
- While sharpening knives, blades and tools, be careful to keep fingers away from sharp edges



Sharpening Systems

Tri-Stone Systems

The base of the tri-stone system acts as an oil reservoir permitting continuous submersion of the unused stones, keeping them clean and saturated, ready for immediate use and years of utility. Rotating the handle brings the desired stone into position for sharpening. All offer a range of replacement stones to replace worn or damaged stones, or substitute different specifications to customize the system.



IM313 MULTI-OILSTONE SHARPENING SYSTEM

BETTER CHOICE FOR LARGE, STRAIGHT-EDGED TOOL SHARPENING

FEATURES AND BENEFITS

- Considered by many to be the ultimate sharpening system, the IM313 contains three oil stones. The 11-1/2" stone length permits long, sweeping strokes for faster and more precise sharpening and honing of all large, wider straight-edged tools. The heavy base has a non-skid bottom.
- A pint of Norton oil, plastic angle guide, and reservoir unit are included with each IM313 system. For general sharpening – coarse Crystolon quickly restores worn edges; medium Crystolon produces the average edge needed for most tools; and fine India stone hones for a sharper edge.



IM200 PROFESSIONAL SHARPENING SYSTEM

BETTER CHOICE FOR A VERSATILE, MULTI-SIZE TOOL AND KNIFE SHARPENER

FEATURES AND BENEFITS

- The smaller 8" stone IM200 system provides the same quality sharpening features as the IM313 – making it the perfect choice for small restaurants and home DIYers.
- The system contains 4-1/2 oz. of lubricating oil, plastic angle guide, and the reservoir unit. For general sharpening – coarse Crystolon quickly restores worn edges; medium Crystolon produces the average edge needed for most tools; and fine India stone hones for a sharper edge.



IM100 3-IN-1 TOOL AND KNIFE SHARPENING SYSTEM

BETTER CHOICE FOR SMALL STRAIGHT-EDGED TOOL SHARPENING

FEATURES AND BENEFITS

- The smallest system, designed for general sharpening, the IM100 is an affordable choice for small knives, cutlery, and woodworking tools.
- 4-1/2 oz. of lubricating oil and a reservoir unit complete the system. For general sharpening – coarse Crystolon quickly restores worn edges; medium Crystolon produces the average edge needed for most tools; and fine India stone hones for a sharper edge.

Portable Sharpening Systems



IM83 PORTABLE SHARPENING STONE SYSTEM

BETTER CHOICE FOR ALL SHARPENING ENTHUSIASTS WHO CARRY THEIR SYSTEM WITH THEM

FEATURES AND BENEFITS

- Sturdy metal latches secure the cover and storage case – where small tools can be housed. The IM83 is designed like all our other sharpening systems; the stones can be replaced to customize the unit to individual requirements.
- Ideal for industrial toolrooms, restaurants, knife manufacturers, DIYers, and sportsmen.
- Both IM83 systems include 3 sharpening stones, an instructional DVD in the base, and a reservoir carrying case. The oil stone system also includes 4-1/2 oz. oil.
- IM83-W Portable Waterstone System – Tool Repair to Fine Finishes
This portable sharpening system is equipped with a carefully engineered sequence of waterstones for clean, efficient sharpening. The waterstones can easily be maintained with the flattening stone provided.
- IM83-O Portable Oil Stone System – Straight-Edged Tool Sharpening
The coarse silicon carbide (Crystolon) stone in this system repairs damaged edges quickly; the medium aluminum oxide (India) stone imparts a durable, smooth cutting edge; and the fine aluminum oxide (India) stone provides the final sharpening and polishing stage.





Sharpening Systems CONTINUED

AVAILABILITY

SIZE	QTY./ PKG.	QTY./ CASE	SPEC.	TIER:	BETTER	
				PRODUCT #	PART #	
IM313 Multi-Oilstone Sharpening System						
11-1/2 x 2-1/2 x 1/2	1	1	1 Coarse Crystolon, 1 Medium Crystolon, 1 Fine India, 1 Pint Oil, Angle Guide, Reservoir Unit		IM313	61463685960
IM200 Professional Sharpening System						
8 x 2 x 3/8	1	1	1 Coarse Crystolon, 1 Medium Crystolon, 1 Fine India, 4-1/2 oz. Oil, Angle Guide, Reservoir Unit		IM200	61463691260
IM100 3-in-1 Tool and Knife Sharpening System						
6 x 2 x 1/2	1	1	1 Coarse Crystolon, 1 Medium Crystolon, 1 Fine India, 4-1/2 oz. Oil, Reservoir Unit		IM100	61463685356
IM83 Portable Systems						
8 x 3 x 1/2	1	1	Oilstones: 1 Coarse Crystolon, 1 Medium India, 1 Fine India, 4-1/2 oz. Oil, Instructional DVD in Base, Reservoir Carrying Case		IM83-O	66243582823
8 x 3 x 1	1	1	Waterstones: 1 ea. of 1000, 4000, 8000 Grit, 1 Flattening Stone, Instructional DVD in Base, Reservoir Carrying Case		IM83-W	66243582825

FOR SHARPENING SYSTEM REPLACEMENT STONES: SEE SINGLE GRIT BENCHSTONE CHARTS ON PAGE 53, OR YOUR NORTON REPRESENTATIVE FOR REPLACEMENT STONES AND PARTS WHICH MAY BE USED AS REPLACEMENTS OR TO CUSTOMIZE YOUR SYSTEM.

Abrasive Files

Norton abrasive files hold their shape while imparting the finest, most uniform finish on precision machine parts and in tool and die making. They are ideal for any deburring, chamfering or radiusing job, or for filing delicate parts. Select the file shape that matches the contour of the surface being stoned.

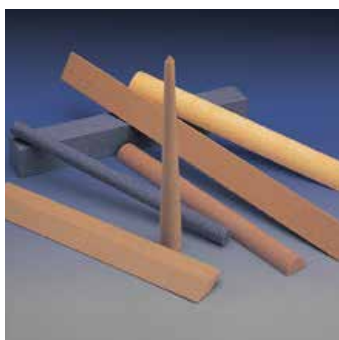

ABRASIVE FILES

BETTER CHOICE FOR ANY DEBURRING, CHAMFERING OR RADIUSING JOB, OR FOR FILING DELICATE PARTS

FEATURES AND APPLICATIONS

- Crystolon Files – Fast-acting silicon carbide products, Crystolon files are designed for use where moderate tolerances are acceptable, and speed of sharpening is more important than fineness.
- India Files – India files are ideal when close tolerance, and strong, keen, long-lasting edges are needed.
- Hard Translucent Arkansas Files – Hard Arkansas has an ultra fine grit that produces the finest edge possible while maintaining tolerances unequalled by any other abrasive file. It will also produce a highly polished finish.

Square Abrasive Files

Square File applications range from dimensioning keyways to maintain fit, stoning faces on router bits, touching-up edges of reamer teeth, and lapping/honing to close tolerances to produce the finest edge on precision instruments, die work and delicate tools.



AVAILABILITY

SIZE (L x H)	QTY./ PKG.	QTY./ CASE	SPEC.	TIER:	BETTER	
				PRODUCT #	PART #	
Square Abrasive Files – Crystolon (Silicon Carbide)						
4 x 3/8	5	5	Fine		FJF34	61463686030
4 x 1/2	5	5	Medium		MJF44	61463686045
			Fine		FJF44	61463686040
Square Abrasive Files – Hard Translucent Arkansas						
3 x 1/4	5	5	Ultra Fine		HF13	61463686590
3 x 3/8	5	5	Ultra Fine		HF33	61463686595
3 x 1/2	5	5	Ultra Fine		HF43	61463686600

ALL SQUARE FILES ARE BULK PACKED

AVAILABILITY

SIZE (L x H)	QTY./ PKG.	QTY./ CASE	SPEC.	TIER:	BETTER	
				PRODUCT #	PART #	
Square Abrasive Files – India (Aluminum Oxide)						
4 x 1/4	5	5	Coarse		CF14	61463686075
			Medium		MF14	61463686070
			Fine		FF14	61463686065
4 x 3/8	5	5	Coarse		CF34	61463686090
			Medium		MF34	61463686085
			Fine		FF34	61463686080
4 x 1/2	5	5	Coarse		CF44	61463686105
			Medium		MF44	61463686100
			Medium		MF44-V	66253325913
			Fine		FF44	61463686095
6 x 1/2	5	5	Coarse		CF46	61463686120
			Medium		MF46	61463686115
			Fine		FF46	61463686110
6 x 5/8	5	5	Medium		MF56	61463686130
			Fine		FF56	61463686125
6 x 3/4	5	5	Coarse		CF66	61463686150
			Medium		MF66	61463686145
			Fine		FF66	61463686140
6 x 1	5	5	Coarse		CF76	61463686165
			Medium		MF76	61463686160
			Fine		FF76	61463686155

V = VENDIBLE PACKAGE. IDEAL FOR VENDING MACHINES, SMALL JOBS, AND CARRYING TO JOB SITE. PRE-PACKED IN STURDY BOXES OF 5 PER PACK. ORDER BY TOTAL NUMBER OF STONES NEEDED; NOT BY QUANTITY OF PACKS.



Abrasive Files CONTINUED

Triangular Abrasive Files

Triangular Files are used for a variety of deburring, chamfering and radiusing applications including cleaning tap threads, stoning cutting surfaces of milling cutters, lapping honing tools, dies and molds, and putting precision points on center punches.

The India line also offers Tapered Triangles, used by mechanics and tool and die makers to impart the correct edge in the least time.

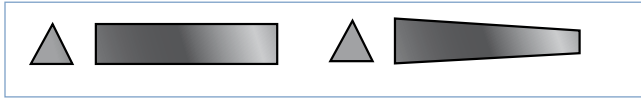

AVAILABILITY

SIZE (L x H)	QTY./ PKG.	QTY./ CASE	SPEC.	PRODUCT #	PART #
Triangular Abrasive Files – Crystolon (Silicon Carbide)					
4 x 1/4	5	5	Fine	FJF114	61463686185
4 x 1/2	5	5	Fine	FJF144	61463686205
Triangular Abrasive Files – Hard Translucent Arkansas					
3 x 1/4	5	5	Ultra Fine	HF113	61463686620
3 x 3/8	5	5	Ultra Fine	HF133	61463686625
3 x 1/2	5	5	Ultra Fine	HF143	61463686630

ALL TRIANGULAR FILES ARE BULK PACKED

Round Abrasive Files

Half Round Files offer both a round and a flat surface for imparting a fine finish on precision machine parts, tools and dies.

Round Files are ideal for deburring, chamfering, radiusing, lapping, honing, cleaning radius tools to a burr-free edge, and dimensioning compound curves on templates.

Round Pointed Files are ideally suited for engravers and die sinkers for stoning difficult recesses on instruments and die tools.

Round Tapered Files are used by craftsmen, woodworkers, and die makers as their unique shape imparts the correct edge quickly.

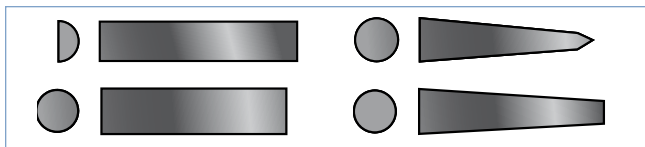

AVAILABILITY

SIZE (L x D)	QTY./ PKG.	QTY./ CASE	SPEC.	PRODUCT #	PART #
Half Round Abrasive Files – India (Aluminum Oxide)					
4 x 1/4	5	5	Medium	MF314	61463686355
	5	5	Fine	FF314	61463686350
4 x 3/8	5	5	Medium	MF334	61463686385
	5	5	Fine	FF334	61463686380
4 x 1/2	5	5	Coarse	CF344	61463686405
	5	5	Medium	MF344	61463686400
	5	5	Fine	FF344	61463686395

ALL HALF-ROUND AND ROUND FILES ARE BULK PACKED

AVAILABILITY

SIZE (L x H)	QTY./ PKG.	QTY./ CASE	SPEC.	PRODUCT #	PART #
Triangular Abrasive Files – India (Aluminum Oxide)					
4 x 1/4	5	5	Coarse	CF114	61463686240
	5	5	Medium	MF114	61463686235
	5	5	Fine	FF114	61463686230
4 x 3/8	5	5	Coarse	CF134	61463686255
	5	5	Medium	MF134	61463686250
	5	5	Fine	FF134	61463686245
4 x 1/2	5	5	Coarse	CF144	61463686270
	5	5	Medium	MF144	61463686265
	5	5	Fine	FF144	61463686260
6 x 1/2	5	5	Coarse	CF146	61463686285
	5	5	Medium	MF146	61463686280
	5	5	Fine	FF146	61463686275
6 x 5/8	5	5	Medium	MF156	61463686295
	5	5	Fine	FF156	61463686290
6 x 3/4	5	5	Medium	MF166	61463686310
	5	5	Fine	FF166	61463686305
6 x 1	5	5	Medium	MF176	61463686325
	5	5	Fine	FF176	61463686320
Triangular Tapered Abrasive Files – India (Aluminum Oxide)					
4 x 1/2 x 1/4	5	5	Medium	MF544	61463686685
	5	5	Fine	FF544	61463686680

AVAILABILITY

SIZE (L x D)	QTY./ PKG.	QTY./ CASE	SPEC.	PRODUCT #	PART #
Round Abrasive Files – Crystolon (Silicon Carbide)					
4 x 1/4	5	5	Medium	MJF214	61463686430
	5	5	Fine	FJF214	61463686425
4 x 3/8	5	5	Medium	MJF234	61463686440
Round Abrasive Files – India (Aluminum Oxide)					
4 x 1/4	5	5	Coarse	CF214	61463686480
	5	5	Medium	MF214	61463686475
	5	5	Fine	FF214	61463686470
4 x 3/8	5	5	Coarse	CF234	61463686495
	5	5	Medium	MF234	61463686490
	5	5	Fine	FF234	61463686485
4 x 1/2	5	5	Coarse	CF244	61463686510
	5	5	Medium	MF244	61463686505
	5	5	Fine	FF244	61463686500
6 x 1/2	5	5	Coarse	CF246	61463686525
	5	5	Medium	MF246	61463686520
	5	5	Fine	FF246	61463686515
6 x 5/8	5	5	Medium	MF256	61463686535
6 x 3/4	5	5	Medium	MF266	61463686550
6 x 1	5	5	Medium	MF276	61463686565
Round Abrasive Files – Hard Translucent Arkansas					
3 x 1/4	5	5	Ultra Fine	HF813	61463686800
Round Pointed Abrasive Files – India (Aluminum Oxide)					
3 x 5/16 Base	5	5	Coarse	CF723	61463686750
	5	5	Medium	MF723	61463686745
	5	5	Fine	FF723	61463686740
Round Pointed Abrasive Files – Hard Translucent Arkansas					
3 x 1/4 Base	5	5	Ultra Fine	HF863	61463686825
Round Tapered Abrasive Files – India (Aluminum Oxide)					
4 x 1/2 x 1/4	5	5	Coarse	CF644	61463686660
	5	5	Medium	MF644	61463686655
	5	5	Fine	FF644	61463686650



Abrasive Files CONTINUED

Diamond-shaped Abrasive Files

Diamond-shaped Files are precision sharpening favorites for cleaning acute angles in dies and molds, and for stoning geometric chasers and sewing machine feeds.



AVAILABILITY		TIER:		BETTER		
SIZE (L x W x H)	QTY./ PKG.	QTY./ CASE	SPEC.	PRODUCT #	PART #	
Diamond-Shaped Abrasive Files – India (Aluminum Oxide)						
4 x 9/16 x 3/16	5	5	Coarse	CT134	61463686720	
	5	5	Medium	MT134	61463686715	
	5	5	Fine	FT134	61463686710	
Diamond-Shaped Abrasive File – Hard Translucent Arkansas						
3 x 1/2 x 3/16	5	5	Ultra Fine	HF843	61463686815	

ALL DIAMOND-SHAPED FILES ARE BULK PACKED

Beveled Abrasive Files

Beveled Files are preferred by exacting artisans, jewelers, mechanics, and watchmakers for honing the finest of finishes. These extremely hard files provide years of service.



AVAILABILITY		TIER:		BETTER		
SIZE (L x W x H)	QTY./ PKG.	QTY./ CASE	SPEC.	PRODUCT #	PART #	
Beveled Abrasive File – Hard Translucent Arkansas						
3 x 3/8 x 1/8	5	5	Ultra Fine	HF833	61463686810	

ALL BEVELED FILES ARE BULK PACKED

Flat Abrasive Files

The Flat File is the choice of mechanics, artisans and jewelers. This long lasting file produces the finest finishes.



AVAILABILITY		TIER:		BETTER		
SIZE (L x W x H)	QTY./ PKG.	QTY./ CASE	SPEC.	PRODUCT #	PART #	
Flat Abrasive File – Hard Translucent Arkansas						
3 x 3/8 x 1/8	5	5	Ultra Fine	HF823	61463686805	

ALL FLAT FILES ARE BULK PACKED

Oval Abrasive Files

The Oval File's shape makes it ideal for finishing and honing recesses or curved edges of precision instruments.



AVAILABILITY		TIER:		BETTER		
SIZE (L x W x H)	QTY./ PKG.	QTY./ CASE	SPEC.	PRODUCT #	PART #	
Oval Abrasive File – Hard Translucent Arkansas						
3 x 1/2 x 3/16	5	5	Ultra Fine	HF853	61463686820	

ALL OVAL FILES ARE BULK PACKED

Knife Blade Abrasive Files

Knife Blade Files are used by clock and watch makers to quickly sharpen, hone, and maintain the edges and points of cutting tools.



AVAILABILITY		TIER:		BETTER		
SIZE (L x W x H)	QTY./ PKG.	QTY./ CASE	SPEC.	PRODUCT #	PART #	
Knife Blade Abrasive Files – India (Aluminum Oxide)						
4 x 1 x 1/8 Back	5	5	Coarse	CF724	61463686780	
	5	5	Medium	MF724	61463686775	
	5	5	Fine	FF724	61463686770	
Knife Blade Abrasive File – Hard Translucent Arkansas						
3 x 3/4 x 1/8	5	5	Ultra Fine	HF873	61463686830	

ALL KNIFE BLADE FILES ARE BULK PACKED

Abrasive File Sets

Hard Translucent Arkansas File Set

This set provides a selection of our most popular square, triangular, round and knife blade files in ultra fine Hard Translucent Arkansas for honing and polishing a wide range of configurations.

Hard Translucent Arkansas-India File Set

This set contains an assortment of files for finishing, honing and polishing applications. It contains a selection of the most popular square, triangular, round and knife blade files in both fine grit India and ultra fine grit Hard Translucent Arkansas.

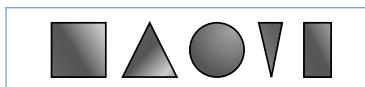

AVAILABILITY		TIER:		BETTER		
SIZE (L x W x H)	QTY./ PKG.	QTY./ CASE		PRODUCT #	PART #	
File Set – Hard Translucent Arkansas						
	1	1			61463686839	
1 Each of Ultra Fine Hard Arkansas HF13, HF113, HF813, and HF873						
File Set – Hard Translucent Arkansas and India (Aluminum Oxide)						
	1	1			61463686840	
1 Each of Ultra Fine Hard Arkansas HF13, HF43, HF113, HF813, HF873, and Fine India FF14, FF44, FF114, FF214, FF724						

See the “Norton Professional Sharpening Products and Dressing Sticks Catalog #200” on www.nortonstones.com to view the complete list and descriptions of our many sharpening products.



Abrasive Files CONTINUED

Engravers' Chuck & Points

Engravers' Points are the choice of professional die-makers for cleaning tight corners and recesses where close tolerances and accuracy are a must. The Engravers' Chuck is a knurled nickel-plated tool designed to hold the Engravers' Point.

AVAILABILITY

SIZE (L x POINT)	QTY./ PKG.	QTY./ CASE	SPEC.	TIER: BETTER	
				PRODUCT #	PART #
Engravers' Chuck					
Engravers' Chuck	5	5		XT1	61463687485
Engravers's Point – India (Aluminum Oxide)					
1 x 1/8 Point	5	5	Fine	FT11	61463687495
Engravers's Point – Soft Arkansas					
1 x 1/8 Point	5	5	Extra Fine	AT11	61463687490

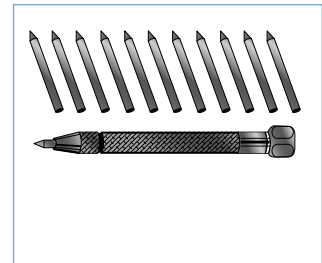

Silversmith Precision Files

These aluminum oxide precision-shaped stones are designed for use by silversmiths and mechanics for close tolerance lapping, touching-up instruments, and for cleaning tools and dies.

AVAILABILITY

SIZE	QTY./ PKG.	QTY./ CASE	SPEC.	TIER: BETTER	
				PRODUCT #	PART #
Silversmith Precision Files – India (Aluminum Oxide)					
4 x 5/16 x 3/16 x 5/16 x 1/16 - X	5	5	Medium	MF414	61463686855
	5	5	Fine	FF414	61463686850
4 x 3/8 x 3/16 x 1/8 x 1/16 - Y	5	5	Medium	MF424	61463686915
	5	5	Fine	FF424	61463686910
4 x 7/16 x 3/16 x 1/8 - BB	5	5	Fine	FF434	61463686940
4 x 1/2 x 1/16 - BB	5	5	Coarse	CF444	61463686965
	5	5	Medium	MF444	61463686960
	5	5	Fine	FF444	61463686955
4 x 1/2 x 1/4 x 5/16 x 1/8 - DD	5	5	Fine	FF464	61463686985
4 x 1/2 x 1/4 x 5/16 x 1/8 - EE	5	5	Medium	MF474	61463687005
	5	5	Fine	FF474	61463687000

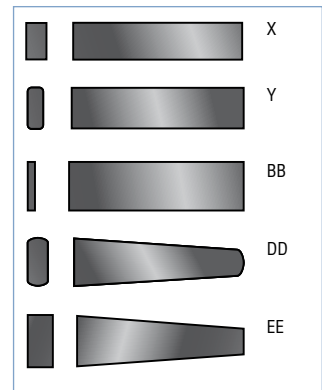

Pocket Stones



POCKET STONES

BETTER CHOICE FOR OUTDOOR ENTHUSIASTS

FEATURES AND BENEFITS

- Convenient and easily transported
- Ideal for outdoor enthusiasts to sharpen scissors, knives, axes, etc.
- Available in a protective case

AVAILABILITY

SIZE (L x W x H)	QTY./ PKG.	QTY./ CASE	SPEC.	TIER: BETTER	
				PRODUCT #	PART #
Pocket Stone – India Sportsman (Aluminum Oxide)					
3 x 1-1/2 x 1/2	50	50	Coarse/Fine	IBP34	61463690705
Pocket Stone – India (Aluminum Oxide)					
4 x 3/4 x 1/4	25	25	Fine	IBP4	61463624153
Pocket Stone with Case – India (Aluminum Oxide)					
3 x 7/8 x 3/8 with case	50	50	Fine	FBP3	61463691122
Pocket Stone with Case – Crystalon (Silicon Carbide)					
3 x 7/8 x 3/8 with case	50	50	Fine	JP14	61463690703
Pocket Stone with Case – Soft Arkansas					
4 x 1 x 3/4 with case; in retail package	5	5	Extra Fine		66253142544
Fish Hook Stone With Pouch – Crystalon Half-Round (Silicon Carbide)					
3" x 1/2" with Pouch	50	50	Fine		61463624072



Abrasive Slips



ABRASIVE SLIPS

BETTER CHOICE FOR IMPARTING FINE, UNIFORM FINISHES

FEATURES AND BENEFITS

- Norton abrasive slips impart the finest, most uniform finishes on curved knives and tools, molders' knives, wood gouges, bead planers, and carbide-tipped tools. These fast-acting slips hold their shape and are long lasting.
- The Crystolon and India stones are designed for preliminary sharpening and the Norton Hard Translucent Arkansas stones are the choice for achieving the finest finish possible.

Carbide Tool Slips

Crystolon (silicon carbide) Slips are used to maintain the edge of carbide tools – keeping regrinding costs and time to an absolute minimum. Not oil-filled.



Round Edge Slips

Round Edge Slips are ideal for precision sharpening and honing of bead planers, curved knives and tools, molders' knives and wood gouges.



AVAILABILITY

SIZE	QTY./ PKG.	QTY./ CASE	SPEC.	TIER: BETTER	
				PRODUCT #	PART #
Carbide Tool Slips – Crystolon (Silicon Carbide)					
3-1/2 x 3/4 x 1/2	5	5	Coarse	CJT63	61463687295
	5	5	Medium	MJT63	61463687290
	5	5	Fine	FJT63	61463687285
Set of Three Above	5	5	Coarse, Medium & Fine	J63	61463687300
Carbide Tool Slips – India (Aluminum Oxide)					
2-1/4 x 7/8 x 3/16	5	5	Medium	MS12	61463687215
Round Edge Slips – Crystolon (Silicon Carbide)					
4-1/2 x 1-3/4 x 1/4 x 1/16	5	5	Medium	MJS24	61463687080
	5	5	Fine	FJS24	61463687075
4-1/2 x 1-3/4 x 1/2 x 3/16	5	5	Coarse	CJS44	61463687100
	5	5	Medium	MJS44	61463687095
	5	5	Fine	FJS44	61463687090
6 x 2-1/4 x 3/4 x 3/8	5	5	Medium	MJS66	61463687110
	5	5	Fine	FJS66	61463687105
Round Edge Slips – India (Aluminum Oxide)					
4 x 1 x 7/16 x 3/16	5	5	Medium	MS14	61463687140
	5	5	Fine	FS14	61463687135
4-1/2 x 1-3/4 x 1/4 x 3/32	5	5	Coarse	CS24	61463687155
	5	5	Medium	MS24	61463687150
	5	5	Fine	FS24	61463687145
4-1/2 x 1-3/4 x 3/8 x 1/8	5	5	Coarse	CS34	61463687170
	5	5	Medium	MS34	61463687165
	5	5	Fine	FS34	61463687160
4-1/2 x 1-3/4 x 1/2 x 3/16	5	5	Coarse	CS44	61463687185
	5	5	Medium	MS44	61463687180
	5	5	Fine	FS44	61463687175
5 x 1 x 5/16 x 3/32	5	5	Medium	MS15	61463687195
	5	5	Fine	FS15	61463687190
Round Edge Slips – Soft Arkansas					
4 x 1-3/4 x 3/8 x 1/8	5	10	Extra Fine	SS4	61463687055
Round Edge Slips – Hard Translucent Arkansas					
3 x 1-3/4 x 1/4 x 1/16	5	10	Ultra Fine	HS3	61463687040
4 x 1-1/4 x 1/4 x 1/8	5	10	Ultra Fine	HS14	61463687050
4 x 1-3/4 x 3/8 x 1/8	5	10	Ultra Fine	HS4	61463687045

Specialty Stones



SPECIALTY STONES

BETTER CHOICE FOR SPECIFIC SHARPENING OR DEBURRING APPLICATIONS

FEATURES AND BENEFITS

- Norton continues to offer specialty stones with optimum specifications and unique shapes that conform to, and quickly sharpen, specific tools



Specialty Stones CONTINUED

Specialty Stones for Machine Tools

Gouge Sharpening Stone

This stone has a unique shape for sharpening and lapping inside and outside curved surfaces on gouges and other cutting tools.

Jointer Stones

These stones provide a fast method of restoring and maintaining the cutting edges of mechanical jointing devices on automatic planers.

Machine Knife Stone

Crystolon (silicon carbide) machine knife stones offer both coarse and fine sides for sharpening and honing paper and cloth-cutting knives and planer knives on the machine. The groove around the middle of the stone protects fingers and provides a secure hold.

Reamer Stones

Durable, fast-cutting stones designed for imparting a professional edge on reamers, taps, and rough rounders on shoe machine tools.

Boat Stones

Boat Stones are medium grit, medium grade stones that are easy to hold and use. Excellent for deburring and breaking sharp edges on dies, fixtures and machined parts, and for deburring grinder magnetic chucks.

AVAILABILITY

SIZE	QTY./ PKG.	QTY./ CASE	SPEC.	TIER: BETTER	
				PRODUCT #	PART #
Gouge Sharpening Stone – India (Aluminum Oxide)					
6 x 2 x 1 x 1/2 x 3/8	5	5	Fine	FS76	61463687305
Jointer Stones					
4 x 3/4 x 3/8 – Crystolon (Silicon Carbide)	5	5	Medium	JE74	61463687335
4 x 3/4 x 3/8 – India (Aluminum Oxide)	5	5	Coarse	IE74	61463687375
4 x 3/4 x 1/2 – Crystolon (Silicon Carbide)	5	5	Medium	JE84	61463687340
Machine Knife Stone – Crystolon (Silicon Carbide)					
4" Diam. x 1-1/2" Thick	5	5	Coarse/Fine	JB74	61463687570
Reamer Stones – India (Aluminum Oxide)					
4-1/2 x 1 x 5/16	10	10	Medium	MT124	61463687420
	10	10	Fine	FT124	61463687415
5 x 1 x 3/16	10	10	Medium	MT125	61463687430
	10	10	Fine	FT125	61463687425
6 x 1 x 1/4	10	10	Medium	MT126	61463687440
	10	10	Fine	FT126	61463687435
Boat Stone – Crystolon (Silicon Carbide)					
9 x 2-1/2 x 1-1/2	10	10	37C80-HV		61463610369
Boat Stone – India (Aluminum Oxide)					
9 x 2-1/2 x 1-1/2	10	10	38A60-IVBE		61463610503

BOAT STONES ARE BULK PACKED

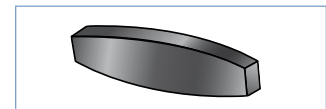
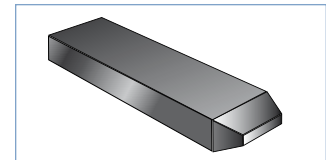
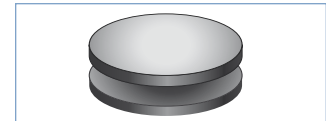
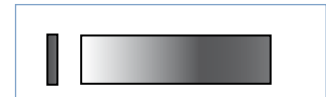
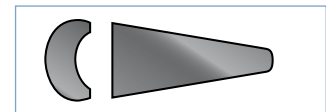

Large Specialty Stones

Tradesmen's Utility Stones

Used for sharpening trimming knives and as an abrasive file in many different industries. The JT910 does not have a handle, while the JT920 and JT930 have wooden handles.

Sickle and Scythe Stones

These silicon carbide stones quickly produce a fast-cutting edge on sickles, scythes, and brush hooks. These stones are most frequently chosen where the speed of sharpening is the primary consideration.

Utility File

A long wedge-shaped stone with four flat sides designed for sharpening coarse cutting edges on cutting implements and edged garden tools. Wooden handles make them easy to use. They will outlast and out-sharpen metal files.

AVAILABILITY

SIZE	QTY./ PKG.	QTY./ CASE	SPEC.	TIER: BETTER	
				PRODUCT #	PART #
Tradesmen's Utility Stones – Crystolon (Silicon Carbide)					
10 x 1-1/4 x 3/4 (Bulk-Packed)	10	10	Medium	JT910	61463687665
14-3/4 Overall (w/ Handle)	10	10	Coarse/Fine	JT930	61463687675
	10	10	Medium	JT920	61463687670
Sickle and Scythe Stones					
10 x 1-1/4 x 3/4 Crystolon (Silicon Carbide)	10	10	Coarse	TJ3	61463687731
10 x 1-5/16 x 3/4 India (Aluminum Oxide)	10	10	Coarse	TD1	61463687715
Utility File – Crystolon (Silicon Carbide) (Bulk-Packed)					
14 Overall (w/ Handle)	10	10	Coarse	JD2	61463687750

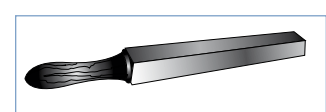
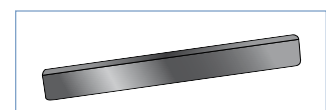
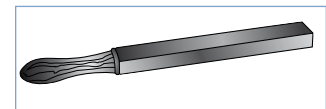



Retail Packaged Sharpening Products

Our retail-packaged line brings Norton quality to your distributor showroom, vending machine, tool crib, and your tool box. Each stone is specifically designed for a popular sharpening application and packaged to sell or carry to the job site.



AVAILABILITY

SIZE (L x W x H)	SPEC.	TIER:	BETTER
		QTY./CASE	PART #
Axe and Hatchet Sharpener			
3 x 5/8 round	Coarse/Fine Crystolon (Silicon Carbide)	10	07660785316
Pocket Knife Sharpener			
3 x 7/8 x 3/8	Fine Crystolon (Silicon Carbide)	5	07660787600
3 x 7/8 x 3/8 with case	Medium India (Aluminum Oxide)	5	07660787937
3 x 1-1/2 x 1/2 with case	Coarse/Fine India (Aluminum Oxide)	5	07660787630
Economy Tool & Knife Benchstone			
6 x 2 x 3/4	Coarse/Fine Crystolon (Silicon Carbide)	5	07660787933
8 x 2 x 3/4	Coarse/Fine India (Aluminum Oxide)	10	07660787934
8 x 2 x 1	Coarse/Fine India (Aluminum Oxide)	10	61463685755
High Quality Tool & Knife Benchstone			
6 x 2 x 3/4	Coarse/Fine Crystolon (Silicon Carbide)	5	07660787935
Chisel & Planer Blade Sharpener			
8 x 2 x 3/4	Coarse/Fine India (Aluminum Oxide)	10	07660787936
Household Knife & Tool Sharpener			
7-1/2	Fine Crystolon (Silicon Carbide)	5	07660787939
Farm Tool Sharpener			
10 x 1-1/4 x 3/4	Coarse Crystolon (Silicon Carbide)	10	07660787730
Lawn & Garden Tool Sharpener			
9-1/2 x 1-3/8 x 1/2	Medium Crystolon (Silicon Carbide)	10	07660787938
Sharpening Stone Oil			
4-1/2 oz.	Oil	5	07660787940
Sharpening Steel			
1/2 x 10	Round file with rubber handle	8	66253240433



Knife and Scissor Sharpener

The knife and scissor mechanical sharpener is a quick and portable tool for hundreds of sharpening applications.

SPECIFICATION	QTY./CASE	PART #
Knife and Scissor Sharpener		
Carbide	6	07660787520

Norton Professional Sharpening Products and Dressing Sticks

See the "Norton Professional Sharpening Products and Dressing Sticks Catalog #200" on www.nortonstones.com to view the complete list and descriptions of our many sharpening products.



CATEGORY DEFINITION

Hard silicon carbide rubbing bricks are used for heavy-duty applications such as rubbing floors, cleaning and scouring castings, rubbing down concrete, and removing mold marks.

APPLICATIONS: Floor Rubbing Bricks – are used to rub down concrete and remove mold marks. These are designed to fit the chucks of common concrete floor grinding equipment. Reusable wooden wedges anchor the bricks to the equipment chucks.

Plain Hand Rubbing Bricks – are the choice of mechanics and foundry workers for dressing grinding wheels and cleaning or scouring castings.

Fluted Hand Rubbing Bricks – are used by masons and stone workers for rubbing down concrete and removing mold marks. The diagonal flutes provide sharp edges, a clean shearing action, and carry away debris.

Fluted Hand Rubbing Bricks with Handle – make quick work of removing mold marks and rubbing down concrete. The firmly attached handle reduces fatigue and facilitates overhead, wall, and floor work.

GRIT RANGE: 6 – 120

ABRASIVE TYPE: Silicon Carbide



SIZE (L x W x H)	QTY./ PKG.	QTY./ CASE	SPEC.	ABRASIVE	PART #
Plain Floor Rubbing Bricks with Wooden Wedges					
4 x 2 x 2	1	6	C6-R	Silicon Carbide	61463653292
	1	6	C10-R	Silicon Carbide	61463653293
	1	6	C24-R	Silicon Carbide	61463653294
	1	6	C80-R	Silicon Carbide	61463653295



SIZE (L x W x H)	QTY./ PKG.	QTY./ CASE	SPEC.	ABRASIVE	PART #
Griddle Brick					
4-1/2 x 3 x 2	1	5	Medium	Alundum	61463687870



SIZE (L x W x H)	QTY./ PKG.	QTY./ CASE	SPEC.	ABRASIVE	PART #
Floor Rubbing Brick with Center Score					
8 x 2 x 2	1	6	C120-R*	Silicon Carbide	61463685296*
*8" BRICK HAS A CENTER SCORE TO FACILITATE DIVIDING THE BRICK IN HALF – AN ECONOMICAL ALTERNATIVE TO BUYING TWO 4" BRICKS.					



SIZE (L x W x H)	QTY./ PKG.	QTY./ CASE	PART #
Wooden Wedges			
	6	6	61463685297



SIZE (L x W x H)	QTY./ PKG.	QTY./ CASE	SPEC.	ABRASIVE	PRODUCT #	PART #
Plain Hand Rubbing Bricks						
8 x 2 x 2	1	5	C24	Silicon Carbide	BP28	61463687830



SIZE (L x W x H)	QTY./ PKG.	QTY./ CASE	SPEC.	ABRASIVE	PRODUCT #	PART #
Fluted Hand Rubbing Bricks						
6 x 2 x 2	1	5	C20	Silicon Carbide	BF26	61463687840
8 x 2 x 2	1	5	C20	Silicon Carbide	BF28	61463687845



SIZE (L x W x H)	QTY./ PKG.	QTY./ CASE	SPEC.	ABRASIVE	PRODUCT #	PART #
Fluted Hand Rubbing Bricks with Handle						
6 x 3 x 1	1	5	C20	Silicon Carbide	BFH6	61463687800
8 x 3-1/2 x 1-1/2	1	5	C20	Silicon Carbide	235	61463687795



the brightest product solutions from **A TOTAL SPECTRUM OF INNOVATION**

For everything from heavy-to-medium stock removal, to fine finishing, to light blending and polishing, coated abrasive products are available in unique abrasive grains, specialty coatings and backing configurations to meet many application needs.

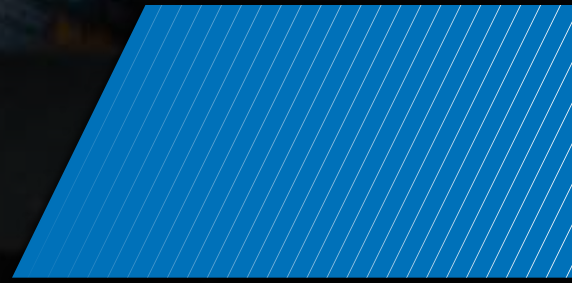

Blaze Your Way to Greater Productivity

The latest-generation, cooler cutting ceramic abrasive grain of Norton Blaze delivers highest productivity on the toughest jobs without the added operator pressure or heavy tool.

PanAmericanDistribution.com



Performance On Fire

Infused with a proprietary NorZon grain upgrade, Norton BlueFire products enhance performance in faster removal rate, longer product life and smoother finish. True Blue, Reinvented.



Power Up Affordable Versatility

The proprietary grain technology and improved resin bond in our Norton Neon products deliver up to 3X the life and cut rate at an economical initial price.

Email: panamericandistribution@gmail.com



CATEGORY DEFINITION

The most heavy-duty of coated abrasive discs with resin over resin construction on heavy-duty vulcanized fiber backing. Designed for applications ranging from heavy stock removal to surface blending. Used with back-up pads on portable angle grinders.

APPLICATIONS:	Stock removal, edge chamfering, weld blending, deburring/deflashing, rust removal, cleaning and finishing
SIZE RANGE:	4" x 5/8" hole, 4-1/2" – 9-1/8" x 7/8" hole
GRIT RANGE:	16 – 120
ABRASIVE GRAIN:	Ceramic Alumina, Zirconia Alumina, and Aluminum Oxide
PRODUCT OPTIONS:	Speed-Change hubs (5/8-11"), AVOS technology
ACCESSORIES:	Air-cooled, smooth-faced, and AVOS back-up pads

MATERIAL-TO-PRODUCT RECOMMENDATION GUIDE

	BEST Highest Productivity – Lowest Total Cost	BETTER Excellent Blend of Performance & Price	GOOD Consistent Performance – Low Initial Price
Stainless Steel / Titanium / Super Alloys*	Norton Blaze F980	Norton BlueFire F826P	Norton Neon F726
Mild Carbon Steel / Welds	Norton Red Heat F981	Norton BlueFire F826P	Norton Neon F726
Ferrous Metals / Cast Iron	Norton Red Heat F981	Norton BlueFire F826P	Norton Neon F726
Brass / Bronze / Aluminum	–	–	Norton Neon F726

*NICKEL/COBALT BASED – HASTELLOY, INCONEL, WASPALLOY

APPLICATION/GRIT RECOMMENDATION GUIDE

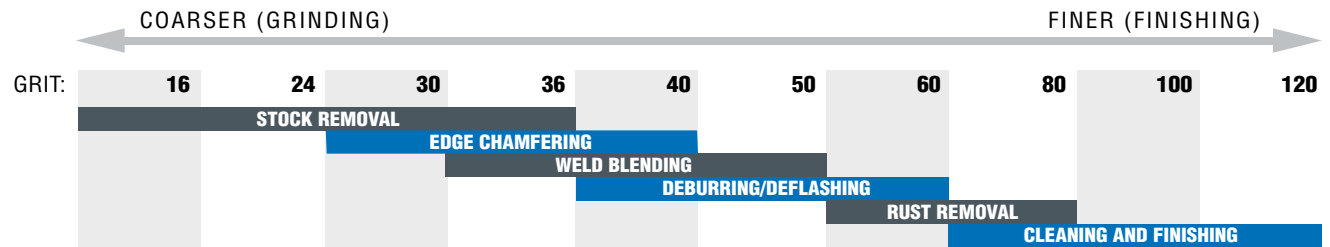

CROSS REFERENCE GUIDE

	BEST		BETTER		GOOD	
	Blaze F980	Red Heat F981	BlueFire F826P	Neon F726	Metal	
NORTON						
3M	985C, 982C	988C, 983C	785C	501C	–	381C
Camel	–	–	Ceramic Blend	–	Zirconia	281C GreenCorp
Flexovit	–	–	Flexon CG	Flexon	–	Specialist
GemTex	–	–	X, PMD	–	ZEE	High Perf
Hermes	CB844X	CB444X/J	–	RB414X/J	–	A
Klingspor	CS661	–	–	CS570	CS565	–
Metabo	–	–	–	–	Z/A	CS561
Mirka	–	–	–	Blue A/Z	Gold A/Z	A
Pearl	–	–	–	–	Zirconia	Red A/O
Pferd	CO Cool	CO	CO-PMD	Z Cool	Z	A/O Premium
Sait	9S	8S	–	3Z	Z	A Cool
SIA	–	4515	–	4815	4819	A
Standard	–	–	Ceramic	–	Zirconia	Red A/O
VSM	XF870	XF750	ZF844	ZF745	ZF713, ZF714	A/O Extra
Walter	–	–	–	Topcut, Inox	–	KF808
Weiler	–	–	–	–	Zirconium	KF708

FEATURED PRODUCTS



NORTON BLAZE F980

BEST CHOICE FOR STAINLESS STEEL, TITANIUM, AND SUPER ALLOYS

FEATURES

- Micro-fracturing ceramic alumina grain
- 100% ceramic alumina grain
- Self-lubricating, advanced supersize treatment
- Improved resin bond system
- Extra heavy-duty backing on 50 grit and coarser
- Foil-packed availability

BENEFITS

- Constantly exposing sharper grain edges and improved grain life
- Significant cut rate and life over competitive blended/low-ratio ceramic alumina discs
- Minimizes heat, loading and glazing on stainless, titanium and super alloys
- Improved grain retention for longer life
- Increased life and durability
- Improved humidity and prevention against curl
- Fully recyclable for reduced landfill waste



NEW

NORTON RED HEAT F981 AND F981S

BEST CHOICE/HIGHEST PRODUCTIVITY FOR MILD CARBON STEEL (F981), STAINLESS (F981S), AND FERROUS METALS

FEATURES

- Premium, self-sharpening full-ratio ceramic abrasive grain
- F981: durable, long lasting
- F981S: supersized grinding aid

BENEFITS

- Faster initial cut rate, longer life and improved finishes versus competitive ceramic discs
- Great performance to price ratio
- Excellent starting specifications when the performance of ceramic is needed
- Excellent performance on carbon steel
- Minimizes heat and loading on stainless and aluminum



VENDIBLE

NORTON BLUEFIRE F826P

BETTER CHOICE FOR STAINLESS, SUPER ALLOYS, STEEL, CAST IRON AND HIGH-PRESSURE APPLICATIONS

FEATURES

- High-performance blend of ceramic alumina and zirconia alumina abrasive
- NEW! Vendible 10-disc package

BENEFITS

- 15% faster cut and longer life with less power draw
- Broad utility on a wide range of materials
- Ideal for vending machines, small jobs, or carrying to a job site



NEW

VENDIBLE

NORTON NEON F726

GOOD CHOICE FOR CARBON STEEL AND ALUMINUM APPLICATIONS

FEATURES

- Proprietary blend of aluminum oxide/ceramic grain
- Upgrade from former Norton Metalite F226 discs at a low initial price
- NEW! Vendible 10-disc package

BENEFITS

- Delivers up to 3X the life and cut rate at an economical price point
- Improved resin bond system and heavy-duty fiber backing extend grain adhesion
- Ideal for vending machines, small jobs, or carrying to a job site



NEW

NORTON METAL F240

GOOD STARTING SPECIFICATION FOR ALL METALS





FEATURES

- High-performance aluminum oxide

BENEFITS

- Low initial price with consistent performance

AVAILABILITY

TIER:				
BRAND:	Norton	Norton	Norton	Norton
TRADENAME:	BLAZE F980	RED HEAT F981	RED HEAT F981S	BLUEFIRE F826P
ABRASIVE:	Ceramic Alumina	Ceramic Alumina	Ceramic Alumina	Ceramic Alumina/ Zirconia Alumina Blend
OTHER:	Supersize		Supersize	

SIZE (D x H)	GRIT	STD. PKG.	PART #	PART #	PART #	STD. PKG.	PART #
4-1/2 x 7/8	24	25	69957398000	77696008400	77696008462	25	66261138457
	36	25	69957398001	77696008401	77696008465	25	66261138456
	36					50 ✓	66623377276
	50	25	69957398002	77696008402	77696008466	25	66261138454
	50					50 ✓	66623377277
	60	25	69957398003	77696008403	77696008467	25	66261138453
	60					50 ✓	66623377278
	80	25	69957398004	77696008404	77696008470	25	66261138452
	80					50 ✓	66623377279
	100	25		77696008405			
	120	25	66254425332	77696008406			
	5 x 7/8	24	25	69957398005	77696008407	77696008480	25
24		50#	66254464822				
36		25	69957398006	77696008412	77696008481	25	66261138562
36		50#	66254464821			50 ✓	66623377283
50		25	69957398007	77696008413	77696008482	50 ✓	66623377284
50		25				25	66261138561
50		50#	66254464820				
60		25	69957398008	77696008414	77696008483	25	66261138601
60						50 ✓	66623377285
80						50 ✓	66623377286
80		25	69957398009	77696008422	77696008484	25	66261138600
100		25		77696008423			
120	25	66254409084	77696008425				
7 x 7/8	24	25	69957398010	77696010018	77696010006	25	66261138594
	36					50 ✓	66623377287
	36	25	69957398011	77696008429	77696010007	25	66261138593
	50					50 ✓	66623377289
	50	25	69957398012	77696008430	77696010008	25	66261138592
	60					50 ✓	66623377290
	60	25	69957398013	77696008431	77696010009	25	66261138591
	80					50 ✓	66623377291
	80	25	69957398014	77696008432	77696010011	25	66261138590
	100	25		77696008433			
	120	25	66254411528	77696008436			
	9-1/8 x 7/8	24	25	69957398015	77696008437	77696010012	25
36		25	69957398016	77696008440	77696010013	25	66261138583
50		25	69957398017	77696008444	77696010017	25	66261138582
60		25		77696008449			
80		25		77696008452			
100		25		77696008453			

NOTE: FIBER DISCS MUST BE USED WITH BACK-UP PADS SHOWN ON THE LAST PAGE OF THIS SECTION.

SHRINK-WRAP FOIL PACK: 10 DISCS PER PACK, 5 PACKS PER STANDARD PACKAGE.

✓ = VENDIBLE PACKAGE. IDEAL FOR VENDING MACHINES & SMALL JOBS . 10 DISC PACKAGE, 5 PACKS PER CARTON. ORDER IN MULTIPLES OF 50.

The Perfect Product for Every Performance/Price Level



NORTON BLAZE

Latest generation ceramic alumina abrasive provides the industry's fastest cutting discs and 50-200% longer life on stainless, titanium, and super alloys.



NORTON BLUEFIRE

Durable ceramic/zirconia abrasive blend for an increased cut rate and longer life over conventional zirconia products on high pressure applications.



NORTON NEON

New aluminum oxide and ceramic blend provides the best starting specification (and performance) when initial price is the primary purchasing consideration.

AVAILABILITY



TIER: **GOOD**
 BRAND: Norton
 TRADENAME: **NEON F726**
 ABRASIVE: Aluminum Oxide/
 Ceramic Alumina Blend



TIER: **GOOD**
 BRAND: Norton
 TRADENAME: **METAL F240**
 ABRASIVE: Aluminum Oxide

SIZE (D x H)	GRIT	STD. PKG.	PART #	STD. PKG.	PART #
4 x 5/8	24	50 ✓	66623395000	25	5539510595
	36	50 ✓	66623395001	25	5539510594
	50	50 ✓	66623395002	25	5539510593
	60	50 ✓	66623395003	25	5539510592
	80	50 ✓	66623395004	25	5539510591
	100	50 ✓	66623395005		
4-1/2 x 7/8	24	50 ✓	66623395007	25	66623353309
	36	50 ✓	66623395008	25	66623353306
	50	50 ✓	66623395009	25	66623353310
	60	50 ✓	66623395010	25	66623353311
	80	50 ✓	66623395011	25	66623353312
	100	50 ✓	66623395012	25	66623353313
5 x 7/8	24	50 ✓	66623395016	25	05539510684
	36	50 ✓	66623395017	25	66623357276
	50	50 ✓	66623395018	25	66623357277
	60	50 ✓	66623395019	25	66623357278
	80	50 ✓	66623395020	25	66623357279
	100	50 ✓	66623395021	25	66623357280
7 x 7/8	24	50 ✓	66623395022	25	66623357281
	36	50 ✓	66623395029	25	66623357282
	50	50 ✓	66623395030	25	05539510693
	60	50 ✓	66623395031	25	66623357283
	80	50 ✓	66623395032	25	66623357284
	100	50 ✓	66623395033	25	66623357285
9-1/8 x 7/8	24	50 ✓	66623395034	25	66623357286
	36	50 ✓	66623395035	25	66623357287
	50	50 ✓	66623395036	25	66623357288
	60	50 ✓	66623395037	25	66623357289
	80	50 ✓	66623395038	25	05539510702
	100	50 ✓	66623395039	25	05539510701
	120	50 ✓	66623395040	25	05539510700
	100	50 ✓	66623395041		05539510699
	120	50 ✓	66623395042	25	05539510695

NOTE: FIBER DISCS MUST BE USED WITH BACK-UP PADS SHOWN ON THE LAST PAGE OF THIS SECTION.

✓ = VENDIBLE PACKAGE. IDEAL FOR VENDING MACHINES & SMALL JOBS . 10 DISC PACKAGE, 5 PACKS PER CARTON. ORDER IN MULTIPLES OF 50.



Corner Store Convenience – Right on the Floor

Metal Fabrication Vending Solutions

See the many popular products conveniently pre-packed in small quantity packages

- Perfect for vending machines, pegboards, new test orders, small orders and jobs, and carrying cleanly to job site
- Pre-selected product assortment for optimal coverage of popular applications
- Available in fiber, flap, paper, and quick-change discs, belts, hand pads, depressed center, cut-off and bench wheels, mounted points, cones and plugs, and sharpening stones

Industry's best selection of vendible abrasive solutions

Speed-Change Fiber Discs

These fiber discs feature Norton quick, tool-free, twist-on and -off Speed-Change fasteners. Discs lock to standard back-up pads with a unique nut design and are easily removed, increasing your productivity with more time to grind.

AVAILABILITY

TIER: BEST	TIER: BEST	TIER: BETTER	TIER: GOOD
BRAND: Norton	BRAND: Norton	BRAND: Norton	BRAND: Norton
TRADENAME: BLAZE F980	TRADENAME: RED HEAT F981	TRADENAME: BLUEFIRE F826P	TRADENAME: NEON F726
ABRASIVE: Ceramic Alumina	ABRASIVE: Ceramic Alumina	ABRASIVE: Ceramic Zirconia	ABRASIVE: Aluminum Oxide/ Ceramic Alumina
OTHER: Supersize			

SIZE (D x H)	GRIT	STD. PKG.	PART #	PART #	PART #	STD. PKG.	PART #
4-1/2 x 5/8-11	24	25	66261023269	77696009735		10	77696009702
	36	25	66261185294	77696009737		10	77696009703
	50	25		77696009739		10	77696009704
	60	25		77696009740		10	77696009712
	80	25		77696009741		10	77696009715
	100	25		77696009746		10	77696009716
	120	25		77696009747		10	77696009723
5 x 5/8-11	24	25	66254425336	77696009748	66261138797	10	77696009725
	36	25	66261185801	77696009749	66261138796	10	66623395014
	50	25		77696009750		10	77696009727
	60	25		77696009752		10	66623395015
	80	25		77696009753		10	77696009728
	100	25		77696009754			
	120	25		77696009755		10	77696009729
7 x 5/8-11	24	25	69957349782	77696009759	66261138819	10	66623395023
	36	25	66261029863	77696009760	66261138818	10	66623395024
	50	25		77696009761	66261138817	10	66623395025
	60	25		77696009762	66261138816		
	80	25		77696009767		10	66623395026
	100	25		77696009771		10	66623395027
	120	25		77696009772		10	66623395028

NOTE: SPEED CHANGE FIBER DISCS MUST ALWAYS BE USED WITH SMOOTH FACE BACK-UP PADS, SEE NEXT PAGE FOR DETAILS.

AVOS Fiber Discs

- Patented, see-through design allows interrupted cut which reduces heat up to 30% over standard discs
- The scooped holes create air flow to pull swarf away from grinding zone; cool cutting and extended product life
- 15° back-up pad for full utilization of discs – no gouging
- Quick, tool-free, twist-on and -off Speed-Lok fasteners

AVAILABILITY

TIER: BEST	TIER: BEST	TIER: BETTER
BRAND: Norton	BRAND: Norton	BRAND: Norton
TRADENAME: BLAZE F980	TRADENAME: RED HEAT F981S	TRADENAME: BLUEFIRE F826P
ABRASIVE: Ceramic Alumina	ABRASIVE: Ceramic Alumina	ABRASIVE: Ceramic Zirconia

SIZE	GRIT	STD. PKG.	PART #	PART #	PART #
4-1/2 Speed-Lok (3 hole)	24	10	66254468389	77696008454	66261129718
	36	10	66254468390	77696008456	66261129719
	50	10	66254468391	77696008457	66261129720
	60	10	66254468392	77696008459	66261129721
	80	10	66254468393	77696008460	66261129722
5 Speed-Lok (3 hole)	24	10	66254468385	77696008471	66261126556
	36	10	66254468386	77696008474	66261126557
	50	10	66254468387	77696008475	66261126558
	60	10	66254468388	77696008477	66261126559
	80	10		77696008478	66261126560
7 Speed-Lok (6 hole)	24	10	66254468381	77696008485	66261137454
	36	10	66254468382	77696010001	66261137455
	50	10	66254468383	77696010002	66261137456
	60	10	66254468384	77696010003	66261137457
	80	10		77696010005	66261137458

NOTE: AVOS FIBER DISCS MUST BE USED WITH AVOS SPEED-LOK BACK-UP PADS, SEE NEXT PAGE FOR DETAILS.





Fiber Disc Accessories



Air-Cooled Standard Back-up Pad

Slotted hub design and curved ribs draw heat away from the grinding zone, reducing disc loading and increasing life. All pads have a 5/8"-11 threaded female hub for mounting. We also offer a no-nose for shorter-shafted right angle grinders.



Smooth Face Speed-Change Back-up Pad

Molded rubber back-up pads with a smooth face.

- Hard density pads are for aggressive cutting action
- Medium density pads are for all-purpose applications



AVOS Fiber Discs

- Patented, see-through design allows interrupted cut which reduces heat up to 30% over standard discs
- The scooped holes create air flow to pull swarf away from grinding zone; cool cutting and extended product life
- 15° back-up pad for full utilization of discs – no gouging
- Quick, tool-free, twist-on and -off Speed-Lok fasteners

DESCRIPTION	MAX. RPM	STD. PKG.	PART #
Rubber Back-up Pads			
Air-Cooled Standard			
4" Medium	12,000	5	63642504918
4-1/2" Medium	11,000	5	63642502122
5" Medium	10,000	5	63642543421
7" Hard	8,600	5	63642543425
7" Medium	8,600	5	63642543422
9" Hard	6,600	5	63642543426
9" Medium	6,600	5	63642543423
NOTE: RETAINER NUTS ARE NOT INCLUDED WITH BACK-UP PADS. THESE MUST BE ORDERED SEPARATELY.			
Air-Cooled No-Nose			
4-1/2" Medium	11,000	5	63642504872
5" Medium	10,000	5	63642503000
7" Medium	8,600	5	66254487375
Smooth Face / Speed-Change			
4-1/2" Medium	20,000	5	66254492277
5" Medium	12,000	5	63642543235
7" Hard	8,600	5	63642543240
7" Medium	8,600	5	63642543245
9" Medium	7,000	5	63642543270
AVOS Speed-Lok Back-up Pads			
AVOS Triangular Speed-Lok Back-up Pads			
4-1/2" x 5/8-11	13,000	5	63642502985
5" x 3/8-24 Pistol Grip*	20,000	5	63642503029
5" x 5/8-11	13,000	5	63642502517
5" x 7/16-20 Pistol Grip*	20,000	5	63642503030
AVOS Round Speed-Lok Back-up Pads			
7" x 5/8-11 Medium	8,600	5	63642504874
*USE ON AIR PNEUMATIC AND HIGH-SPEED PISTOL GRIP SANDERS			
Tools			
#103 Retainer Nut	—	10	63642543463
Spanner Wrench	—	5	63642543005
66NS Short Retainer Nut	—	10	63642543461



CATEGORY DEFINITION

Flap discs are versatile grinding and finishing tools, consisting of three main components: a backing plate, adhesive, and abrasive cloth flaps. The rectangular flaps are overlapped and glued to the backing plate. Flap discs are designed for right angle grinder applications ranging from heavy stock removal to surface blending.

- APPLICATIONS:** Grinding, stock removal, edge chamfering/beveling, weld blending, deburring/deflashing, rust removal, blending, cleaning and finishing
- SIZE RANGE:** 4": 5/8" hole
4-1/2" - 7": 5/8"-11 discard mount, 7/8" hole, and 2" - 3" quick-change
- GRIT RANGE:** 24 - 120
- ABRASIVE GRAIN:** Ceramic Alumina, Zirconia Alumina, Aluminum Oxide,
- ABRASIVE FLAPS:** Polyester or cotton
- FLAP DISC SHAPE:** Type 27 Flat and Type 29 Conical
- ABRASIVE FLAP DENSITY:** Standard or high
- BACKING PLATE MATERIAL:** Fiberglass and plastic

FLAP DISC SHAPES



GRIND AT FLATTER ANGLES:
0° - 15°

Type 27 Flat – The Best Choice for Finishing

- Used primarily on flat surfaces
- The best choice for blending and smooth finishing

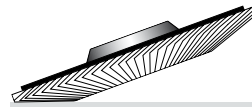

GRIND AT STEEPER ANGLES:
15° - 25°

Type 29 Conical – The Best Choice for Aggressive Stock Removal

- Conical flap discs have angled flaps and may be used on both contoured and edge work
- The angle provides greater surface contact for stock removal on flat surfaces
- The best choice when speed and stock removal are primary considerations

ABRASIVE FLAP DENSITIES



Standard Density

- Excellent for heavy-duty applications and rapid stock removal



High Density

- Ideal when working on uneven or curved surfaces, as well as finer grit blending

BACKING PLATE MATERIALS

All flap discs are a combination of abrasive flaps adhered to a rigid backing plate. It is the backing plate that provides stability during operation. There are two main materials used: fiberglass and plastic. The fiberglass backing plate, along with the flap shape, helps to absorb vibration and is consumed during use with no smearing. Fiberglass is the most popular material because of its high strength and light weight. The plastic backing plate offers some additional conformability and is trimmable.

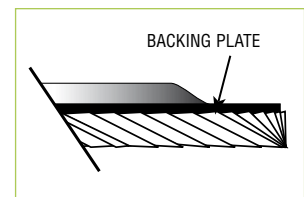

WHY CHOOSE FLAP DISCS?

Flap discs replace both grinding wheels and fiber discs. The same flap disc can be used for applications ranging from stock removal to blending.

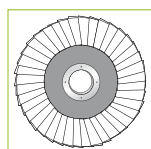

Flap Discs vs. Grinding Wheels

- Faster stock removal
- Smoother finish, no gouging
- Cooler cutting, less glazing
- Lightweight, easier to control
- Less vibration, less operator fatigue
- Reduced noise

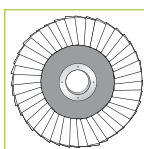
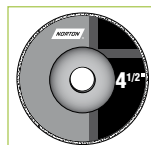

Flap Discs vs. Fiber Discs

- 20X longer life, reduced abrasive cost
- Fewer disc changes, reduced labor cost
- More consistent finish
- No back-up pad required
- Easier storage, no curling
- Reduced loading
- Use flap discs one grit size coarser than fiber discs, except in 36 grit.

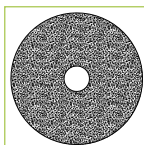



MATERIAL-TO-PRODUCT RECOMMENDATION GUIDE

BEST Highest Productivity – Lowest Total Cost	BETTER Excellent Blend of Performance & Price	GOOD Consistent Performance – Lowest Total Cost
---	---	---

Type 29 for Stock Removal

Stainless Steel / Titanium / Super Alloys	Norton Blaze R980P	Norton BlueFire R884P	Norton Neon R766
Mild Carbon Steel / Welds	Norton Red Heat R961	Norton BlueFire R884P	Norton Neon R766
Ferrous Metals / Cast Iron	Norton Red Heat R961	Norton BlueFire R884P	Norton Neon R766
Brass / Bronze / Aluminum	–	Norton BlueFire R884P	

Type 27 for Blending and Finishing

Stainless Steel / Titanium / Super Alloys	Norton Blaze R980P	Norton BlueFire R884P	Norton Neon R766
Mild Carbon Steel / Welds	Norton Red Heat R961	Norton BlueFire R884P	Norton Neon R766
Ferrous Metals / Cast Iron	Norton Red Heat R961	Norton BlueFire R884P	Norton Neon R766
Brass / Bronze / Aluminum	–	Norton BlueFire R884P	Norton Neon R766

APPLICATION/GRIT RECOMMENDATION GUIDE

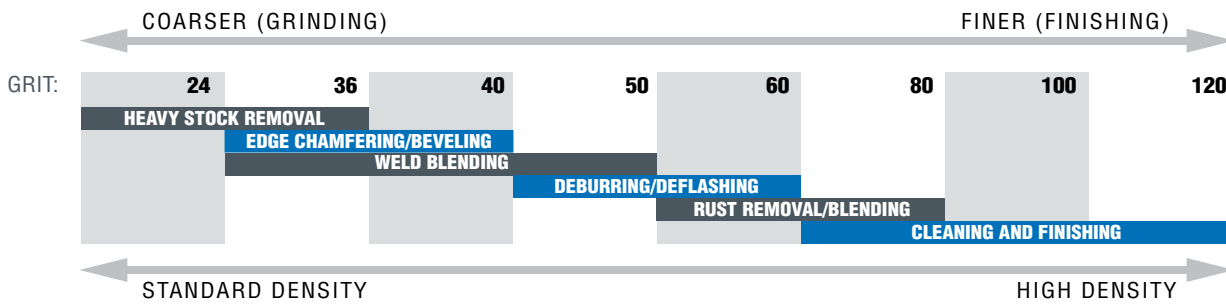

CROSS REFERENCE GUIDE



	BEST		BETTER	GOOD
	Blaze R980P	Red Heat R961	BlueFire R884P	Neon R766
NORTON				
3M	947D	747D	563D, 546D	–
DeWalt	–	–	–	Z/A
Camel	–	C3	Z-Stainless	Z3, A3
Flexovit	–	–	–	Zircotex Premium, Zircotex HP
Garryson	–	–	Zirc+, Zirconium	Aluminum Oxide
GemTex	–	Ceramic	–	Zirconia, A/O
Hermes	–	–	–	–
Klingspor	–	–	SMT 630	SMT 618, 619, 624, 626, 627, 628, 640
Metabo	–	–	–	Z/A
Pearl	–	Stainless Max	Zirconia Premium, TuffMax	Z/A Silver Line, Premium A/O Classic, Silver Line
Pferd	–	Ceramic	Cool Zirconia, CO-COOL	Zirconia, Cool Aluminum Oxide, Aluminum Oxide
Sait	–	–	Z	2A, 3A
SIA	–	–	–	Z/A
Standard	–	Ceramic Oxide	Zirconia Pro	Zirconia
Tyrolit	–	–	Z/A	A/O
Walter	–	–	Enduro Flex	–
Weiler	–	Saber Tooth Ceramic	–	Tiger Zirconium, A/O, Vortec



FEATURED PRODUCTS



EXPANDED OFFERING

NORTON BLAZE R980P

BEST/HIGHEST PRODUCTIVITY FOR STAINLESS STEEL, TITANIUM, AND SUPER ALLOYS

FEATURES

BENEFITS

- | | |
|--|--|
| ■ Latest-generation ceramic alumina abrasive grain | ■ Last 50% – 200% longer than any flap discs on stainless steel, cobalt, chrome, Inconel, titanium and other hard-to-grind materials |
| ■ Y-weight polyester flaps with a supersize grinding aid | ■ Significantly improve life, grain retention, and fray resistance while providing a cool, noticeably fast cut rate |
| ■ Durable fiberglass back on Type 29 and Type 27 HD | ■ High strength, lightweight, absorbs vibration |
| ■ Orange, flexible plastic backing plate on Type 27 Quick Trim | ■ The industry standard for trimmability |
| ■ NEW! 2" and 3" quick-change mini flap discs | ■ Ideal for tight spaces |



NORTON RED HEAT R961

BEST/HIGH PRODUCTIVITY FOR MILD CARBON STEEL, AND FERROUS METALS

FEATURES

BENEFITS

- | | |
|---|--|
| ■ Premium ceramic and zirconia alumina abrasive blend | ■ Excellent performance and efficiencies on mild carbon steel and ferrous metal/cast iron applications |
| ■ Durable, fiberglass back on Type 29 | ■ High strength, lightweight, absorbs vibration |
| ■ Red, flexible plastic backing plate on Type 27 Quick Trim | ■ The industry standard for trimmability |



EXPANDED OFFERING

NORTON BLUEFIRE R884P

BETTER CHOICE FOR MILD CARBON STEEL, AND WELDS

FEATURES

BENEFITS

- | | |
|--|---|
| ■ High performance zirconia alumina plus abrasive | ■ Aggressive cut and long life |
| ■ Polyester flaps with semi-open coat | ■ Up to 30% longer life than competitive zirconia alumina products |
| ■ Durable, fiberglass back on Type 29 and NEW Type 27 HD | ■ Improved durability and retards loading on aluminum |
| ■ Blue, flexible plastic backing plate on Type 27 Quick Trim | ■ High strength, lightweight, absorbs vibration |
| ■ NEW! Vendible 2-disc package | ■ The industry standard for trimmability |
| ■ NEW! 2" and 3" quick-change mini flap discs | ■ ideal for vending machines, small jobs, or carrying to a job site |
| | ■ Ideal for tight spaces |



NORTON NEON R766

GOOD CHOICE FOR ALUMINUM, BRASS, BRONZE, STAINLESS, CARBON STEEL, AND TITANIUM

FEATURES

BENEFITS

- | | |
|--|---|
| ■ Alternating aluminum oxide (black) and zirconia alumina (blue) flaps | ■ Ideal when purchasing criteria is a good-performing, economically-priced, general purpose disc |
| ■ New resin system and alternating Y-weight polyester and cotton flaps | ■ Improved base adhesion and 30%+ improvement in life over key competitors' aluminum oxide flap discs |
| ■ Unique grain coating | ■ Stand up on light- to moderately-demanding applications |
| ■ Fiberglass back on Type 29 and Type 27 HD | ■ Longer life and faster cut rate |
| ■ Green, flexible plastic backing plate on Type 27 Quick Trim | ■ High strength, lightweight, absorb vibration |
| | ■ The industry standard for trimmability |



NEW

NORTON METAL R828

GOOD CONSISTENT PERFORMANCE WITH LOW INITIAL PRICE

FEATURES

BENEFITS

- | | |
|-------------------------------------|--|
| ■ Durable zirconia alumina abrasive | ■ Maximum cut rate and life with consistent finish |
|-------------------------------------|--|



AVAILABILITY



TIER:
BRAND
TRADENAME:
SHAPE:
FLAP DENSITY
ABRASIVE:
BACKING PLATE:
OTHER:

BEST	BEST	BETTER	GOOD	GOOD
Norton	Norton	Norton	Norton	Norton
BLAZE R980P	RED HEAT R961	BLUEFIRE R884P	NEON R766	METAL R828
Type 29 Conical	Type 29 Conical	Type 29 Conical	Type 29 Conical	Type 29 Conical
Standard	Standard	Standard	Standard	Standard
Ceramic Alumina	Ceramic Alumina/ Zirconia Alumina	Zirconia Alumina Plus	Aluminum Oxide/ Zirconia Alumina	Zirconia Alumina
Fiberglass	Fiberglass	Fiberglass	Fiberglass	Fiberglass
Supersize				

SIZE (D x H)	GRIT	MAX. RPM	STD. PKG.	PART #	PART #	PART #	PART #	PART #
Type 29 Conical								
4 x 5/8	36	15,300	10			66623399049		
	40	15,300	10			66623399050		
	60	15,300	10			66623399051		
	80	15,300	10			66623399052		
4-1/2 x 5/8-11	36	13,300	10	66261183490	66623399053*	66254461165	66623399028	66254419991
	36	13,300	10			66623341104 2-Pack		
	40	13,300	10	66261183491	63642536156*	66254461167	66623399029	66254419994
	60	13,300	10	66261183492	63642536157*	66254461170	66623399030	66254419996
	60	13,300	10			66623341105 2-Pack		
	80	13,300	10	66261183493	63642536158*	66254461173	66623399173	66254419997
	80	13,300	10			66623341106 2-Pack		
	120	13,300	10		63642597115*		66623399174	
4-1/2 x 7/8	24	13,300	10			66623399204		
	36	13,300	10	66261183486	63642504329	66254461155	66623399032	66254419963
	36	13,300	10			66623341107 2-Pack		
	40	13,300	10	66261183487	63642504330	66254461161	66623399033	66254419978
	60	13,300	10	66261183488	63642504331	66254461163	66623399034	66254419984
	60	13,300	10			66623341108 2-Pack		
	80	13,300	10	66261183489	63642504332	66254461164	66623399035	66254419987
	80	13,300	10			66623341109 2-Pack		
	120	13,300	10		63642504333		66623399175	
5 x 5/8-11	36	12,000	10		66623399197*	66623399189	66623399176	
	36	12,000	10			66623341110 2-Pack		
	40	12,000	10		66623399198*	66623399190	66623399177	
	60	12,000	10		66623399199*	66623399191	66623399178	
	60	12,000	10			66623341111 2-Pack		
	80	12,000	10		66623399200*	66623399192	66623399179	
	80	12,000	10			66623341112 2-Pack		
	120	12,000	10		66623399201*		66623399180	
5 x 7/8	24	12,000	10			66623399206		
	36	12,000	10	66261190001	66623399054	66254461174	66623399036	66254419998
	36	12,000	10			66623341113 2-Pack		
	40	12,000	10	66261190002	66623399055	66254461176	66623399037	66254420001
	60	12,000	10	66261190003	66623399056	66254461177	66623399038	66254420002
	60	12,000	10			66623341114 2-Pack		
	80	12,000	10	66261190004	66623399057	66254461178	66623399039	66254420003
	80	12,000	10			66623341115 2-Pack		
	120	12,000	10		66623399202		66623399181	
6 x 5/8-11	40	10,200	10				66623399040	66254491779
	60	10,200	10				66623399041	66254491780
	80	10,200	10				66623399042	66254491781
6 x 7/8	24	10,200	10			66623399066		
	36	10,200	10			66623399298		
	40	10,200	10		63642541406	66623399193	66623399182	66254491776
	60	10,200	10		63642541407	66623399194	66623399183	66254491777
	80	10,200	10		63642541408	66623399195	66623399184	66254491778
	120	10,200	10					
7 x 5/8-11	36	8,600	10	66261183498	66623399058*	66254461188	66623399185	66254420009
	36	8,600	10			66623341116 2-Pack		
	40	8,600	10	66261183499	63642536159*	66254461190	66623399043	66254420010
	60	8,600	10	66261183500	63642536160*	66254461192	66623399044	66254420012
	60	8,600	10			66623341117 2-Pack		
	80	8,600	10	66261183501	63642536161*	66254461193	66623399045	66254420013
	80	8,600	10			66623341118 2-Pack		
	120	8,600	10		66623399203*		66623399186	
7 x 7/8	24	8,600	10			66623399196		
	36	8,600	10	66261183494	63642504334	66254461180	66623399187	66254420004
	36	8,600	10			66623341119 2-Pack		
	40	8,600	10	66261183495	63642504335	66254461183	66623399046	66254420006
	60	8,600	10	66261183496	63642504336	66254461185	66623399047	66254420007
	60	8,600	10			66623341120 2-Pack		
	80	8,600	10	66261183497	63642504337	66254461186	66623399048	
	80	8,600	10			66623341121 2-Pack		
	120	8,600	10		63642504338		66623399188	



AVAILABILITY

					
TIER:	BEST	BEST	BEST	BETTER	BETTER
BRAND:	Norton	Norton	Norton	Norton	Norton
TRADENAME:	BLAZE R980P	BLAZE R980P	RED HEAT R961	BLUEFIRE R884P	BLUEFIRE R884P
SHAPE:	Type 27 Flat	Type 27 Flat	Type 27 Flat	Type 27 Flat	Type 27 Flat
FLAP DENSITY:	Standard	High	Standard	Standard	High
ABRASIVE:	Ceramic Alumina	Ceramic Alumina	Ceramic Alumina/ Zirconia Alumina	Zirconia Alumina Plus	Zirconia Alumina Plus
BACKING PLATE:	Quick Trim Plastic	Fiberglass	Quick Trim Plastic	Quick Trim Plastic	Fiberglass
OTHER:	Supersize	Supersize			

SIZE (D x H)	GRIT	MAX. RPM	STD. PKG.	PART #	PART #	PART #	PART #	PART #
Type 27 Flat								
4 x 5/8	40	15,300	10			63642536153		
	60	15,300	10			63642536154		
	80	15,300	10			63642536155		
4-1/2 x 5/8-11	36	13,300	10		66254499894	66623399163*	66623399136	
	36	13,300	10	✓			66623341086 2-Pack	
	40	13,300	10		66254400257	66261098290	66623399137	77696090086
	60	13,300	10		66254400258	66261096435	66623399138	77696090087
	60	13,300	10	✓			66623341087 2-Pack	
	80	13,300	10		66254400259	66261096436	66623399139	77696090088
	80	13,300	10	✓			66623341088 2-Pack	
	120	13,300	10		66254400261	66623399164*		
4-1/2 x 7/8	36	13,300	10		63642501865	66261097678	66623399140	77696090081
	36	13,300	10	✓			66623341089 2-Pack	
	40	13,300	10		66254400253	66261020628	66623399141	77696090082
	60	13,300	10		66254400254	66261020633	66623399142	77696090083
	60	13,300	10	✓			66623341090 2-Pack	
	80	13,300	10		66254400255	66261020634	66623399143	77696090084
	80	13,300	10	✓			66623341091 2-Pack	
	120	13,300	10		66254400256	63642505279		77696090085
5 x 5/8-11	36	12,000	10			66623399165*	66623399144	
	36	12,000	10	✓			66623341092 2-Pack	
	40	12,000	10		77696090141	66254491941*	66623399145	
	60	12,000	10		77696090142	66254491942*	66623399146	
	60	12,000	10	✓			66623341093 2-Pack	
	80	12,000	10		77696090143	66254491943*	66623399147	
	80	12,000	10	✓			66623341094 2-Pack	
	120	12,000	10		77696090144	66623399166*		
5 x 7/8	36	12,000	10			63642505281	66623399148	
	36	12,000	10	✓			66623341095 2-Pack	
	40	12,000	10		66254400262	63642505282	66623399149	
	60	12,000	10		66254400264	63642505283	66623399150	
	60	12,000	10	✓			66623341096 2-Pack	
	80	12,000	10		66254400265	63642505284	66623399151	
	80	12,000	10	✓			66623341097 2-Pack	
	120	12,000	10		66254400519	63642505285		
6 x 5/8-11	40	10,200	10			66623399167*		
	60	10,200	10			66623399168*		
	80	10,200	10			66623399169*		
6 x 7/8	36	10,200	10			66623399024	66623399152	
	40	10,200	10			66623399025	66623399153	
	60	10,200	10			66623399026	66623399154	
	80	10,200	10			66623399027		
	120	10,200	10			66623399170*		
7 x 5/8-11	36	8,600	10			66623399170*	66623399155	
	36	8,600	10	✓			66623341098 2-Pack	
	40	8,600	10		66254461066	63642536150*	66623399156	77696090092
	60	8,600	10		66254461067	63642536151*	66623399157	77696090093
	60	8,600	10	✓			66623341099 2-Pack	
	80	8,600	10		66254461068	63642536152*	66623399158	77696090094
	80	8,600	10	✓			66623341100 2-Pack	
	120	8,600	10		66254461069	66623399171*		
7 x 7/8	36	8,600	10		63642501866	63642504880	66623399159	
	36	8,600	10	✓			66623341101 2-Pack	
	40	8,600	10		66254461059	63642504881	66623399160	77696090089
	60	8,600	10		66254461060	63642504882	66623399161	77696090090
	60	8,600	10	✓			66623341102 2-Pack	
	80	8,600	10		66254461061	63642504883	66623399162	77696090091
	80	8,600	10	✓			66623341103 2-Pack	
	120	8,600	10		66254461063	66623399172		

* 5/8-11 (HUBBED) RED HEAT FLAP DISC STD. PKG. QUANTITY = 5
 ✓ = VENDIBLE PACKAGE. IDEAL FOR VENDING MACHINES & SMALL JOBS. 2 FLAP DISCS/PACK, 5 PACKS/CARTON. ORDER IN MULTIPLES OF 10.



AVAILABILITY



TIER:	GOOD	GOOD	GOOD
BRAND:	Norton	Norton	Norton
TRADENAME:	NEON R766	NEON R766	METAL R828
SHAPE:	Type 27 Flat	Type 27 Flat	Type 27 Flat
FLAP DENSITY:	Standard	High	Standard
ABRASIVE:	Aluminum Oxide/ Zirconia Alumina	Aluminum Oxide/ Zirconia Alumina	Zirconia Alumina
BACKING PLATE:	Quick Trim Plastic	Fiberglass	Fiberglass
OTHER:			

SIZE (D x H)	GRIT	MAX. RPM	STD. PKG.	PART #	PART #	PART #
Type 27 Flat (continued)						
4 x 5/8	40	15,300	10			
	60	15,300	10			
	80	15,300	10			
4-1/2 x 5/8-11	36	13,300	10	66623399125	66623399205	66254472655
	40	13,300	10	66623399000	66623399059	66254437013
	60	13,300	10	66623399001	66623399060	66254472656
	80	13,300	10	66623399002	66623399061	66254472657
	120	13,300	10	66623399003		
4-1/2 x 7/8	36	13,300	10	66623399126	66623399062	66254472653
	40	13,300	10	66623399004	66623399063	66254437004
	60	13,300	10	66623399005	66623399064	66254448989
	80	13,300	10	66623399006	66623399065	66254448990
	120	13,300	10	66623399007		
5 x 5/8-11	36	12,000	10	66623399127	66623399207	
	40	12,000	10	66623399128	66623399208	
	60	12,000	10	66623399130	66623399209	
	80	12,000	10	66623399131	66623399210	
	120	12,000	10	66623399132		
5 x 7/8	36	12,000	10	66623399133	66623399211	66254472659
	40	12,000	10	66623399008	66623399212	66254472660
	60	12,000	10	66623399009	66623399213	66254472661
	80	12,000	10	66623399010	66623399214	66254472662
	120	12,000	10	66623399011		
6 x 5/8-11	40	10,200	10		66623399219	66254491773
	60	10,200	10		66623399220	66254491774
	80	10,200	10		66623399221	66254491775
6 x 7/8	36	10,200	10		66623399215	
	40	10,200	10	66623399012	66623399216	66254491770
	60	10,200	10	66623399013	66623399217	66254491771
	80	10,200	10	66623399014	66623399218	66254491772
	120	10,200	10	66623399015		
7 x 5/8-11	36	8,600	10	66623399134	66623399222	66254472669
	40	8,600	10	66623399016	66623399067	66254472670
	60	8,600	10	66623399017	66623399068	66254472671
	80	8,600	10	66623399018	66623399069	66254472672
	120	8,600	10	66623399019		
7 x 7/8	36	8,600	10	66623399135	66623399070	66254472664
	40	8,600	10	66623399020	66623399071	66254472665
	60	8,600	10	66623399021	66623399072	66254472666
	80	8,600	10	66623399022	66623399073	66254472667
	120	8,600	10	66623399023		

When You Want Fast and Tough, You Want Norton

Whether you want maximum productivity or simply the lowest initial cost solution, Norton has the product for all your right angle grinding and blending applications.



BEST Norton Blaze

Highest Productivity – Lowest Total Cost



BETTER Norton BlueFire

Exceptional Blend of Performance and Price



GOOD Norton Neon

Good Performance – Low Initial Price



NORTON BLUEFIRE 20X R884P

PACKAGED FOR RETAIL / WALK-IN SELLING / SMALL JOBS

FEATURES & BENEFITS

- Zirconia alumina abrasive for aggressive cut and long life
- Individual hang card provides product selling points
- Product ships in merchandisable display case of small quantities
- Available wire rack (with header card) allows merchandising of 4 and 4-1/2 product three ways: hung on pegboard, mounted on an upright, or placed on a shelf/counter

AVAILABILITY

TIER:	BETTER
BRAND:	Norton
TRADENAME:	BLUEFIRE 20X R884P
SHAPE:	Type 29
FLAP DENSITY:	Standard
ABRASIVE:	Zirconia Alumina Plus
BACKING PLATE:	Fiberglass

SIZE (D x H)	GRIT	MAX. RPM	STD. PKG.	PART #
4 x M-10	40	15,300	5	07660703214
	60	15,300	5	07660703215
	80	15,300	5	07660703216
4-1/2 x 5/8-11	40	13,300	5	07660703211
	60	13,300	5	07660703212
	80	13,300	5	07660703213
7 x 5/8-11	40	8,600	5	07660703205
	60	8,600	5	07660703206
	80	8,600	5	07660703207
Wire Rack			2	07660704157



WIRE RACK (WITH HEADER CARD) ALLOWS MERCHANDISING OF 4" AND 4-1/2" PRODUCT THREE WAYS: HUNG ON PEGBOARD, MOUNTED ON AN UPRIGHT, OR PLACED ON A SHELF/COUNTER



NORTON MINI FLAP DISCS

PACKAGED FOR RETAIL / WALK-IN SELLING / SMALL JOBS

FEATURES & BENEFITS

- High performance ceramic and zirconia alumina abrasive provide maximum cut rate and life
- Layered flaps wear away evenly, producing a high quality and consistent finish



AVAILABILITY

TIER:	BEST	BETTER	BEST	BETTER
BRAND:	Norton	Norton	Norton	Norton
TRADENAME:	BLAZE R980P	BLUEFIRE R884P	BLAZE R980P	BLUEFIRE R884P
ABRASIVE:	Ceramic Alumina	Zirconia Alumina	Ceramic Alumina	Zirconia Alumina
FLAP:	Polyester	Polyester	Polyester	Polyester
BACKING MATERIAL:	Extra Heavy-Duty Plastic	Extra Heavy-Duty Plastic	Extra Heavy-Duty Plastic	Extra Heavy-Duty Plastic
ATTACHMENT:	TR (Type III)	TR (Type III)	TS (Type II)	TS (Type II)



SIZE (D)	GRIT	STD. PKG.	PART #	PART #	PART #	PART #
2	36	10	77696090145	77696090165	77696090155	77696090175
	40	10	77696090146	77696090166	77696090156	77696090176
	60	10	77696090147	77696090167	77696090157	77696090177
	80	10	77696090148	77696090168	77696090158	77696090178
	120	10	77696090149	77696090169	77696090159	77696090179
3	36	10	77696090150	77696090170	77696090160	77696090180
	40	10	77696090151	77696090171	77696090161	77696090181
	60	10	77696090152	77696090172	77696090162	77696090182
	80	10	77696090153	77696090173	77696090163	77696090183
	120	10	77696090154	77696090174	77696090164	77696090184

DESCRIPTION	STD. PKG.	MAX. RPM	PART #
Mini Flap Disc Back-up Pads			
2" and 3" TS (Type II) Back-up Pads	1	30,000	08834168539
2" and 3" TR (Type III) Back-up Pads	1	30,000	08834164922

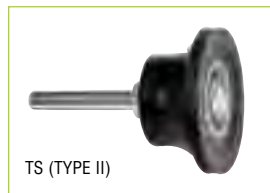



CATEGORY DEFINITION

For use on random orbital and rotary sanders. The industry's highest performing and broadest selection of paper discs in PSA (pressure sensitive adhesive) disc rolls and individual discs, and hook and loop discs.

APPLICATIONS:	Stripping and preparing primed and painted surfaces for finishing, sanding of plastics, fiberglass and composites, bare wood sanding, light weld blending, preparing and finishing metal, and sanding of all gel coat and body filler compounds
SIZE RANGE:	3" – 8"
GRIT RANGE:	36 – 1500
ABRASIVE GRAIN:	Ceramic Alumina, Zirconia Alumina, Aluminum Oxide, Silicon Carbide
ATTACHMENT SYSTEMS:	PSA (pressure-sensitive adhesive), hook and loop
PAPER WEIGHTS:	Heavyweight – E and F; Lightweight – B and C
VACUUM HOLES:	See product availability charts

MATERIAL/APPLICATION-TO-PRODUCT RECOMMENDATION GUIDE

	BEST Highest Productivity – Lowest Total Cost		BETTER Excellent Blend of Performance & Price		GOOD Consistent Performance – Low Initial Price
	Heavy-Medium Stock Removal	Light Stock Removal-Finishing	Heavy-Medium Stock Removal	Light Stock Removal-Finishing	Light Stock Removal-Finishing
Primed, Painted Surfaces		A975	H875P	A275	PB273
Fiberglass / Composites / Gel Coats		A975	H875P	A275	PB273
Wood		A975	H875P	A275	PB273
Metal	H920	A975	H822	A275	PB273
Body Fillers / Compounds / Plastics		A975	H875P	A275	PB273

APPLICATION/GRIT RECOMMENDATION GUIDE

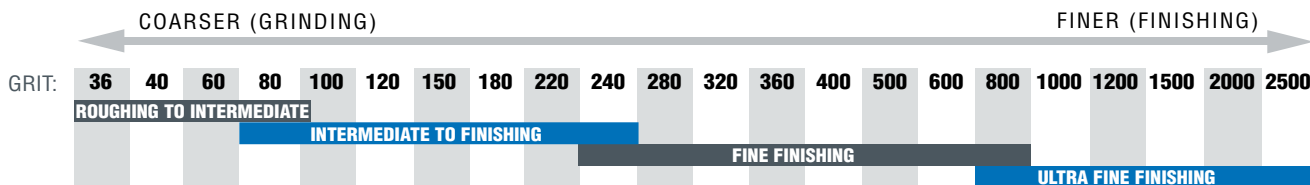

CROSS REFERENCE GUIDE



	BEST		BETTER					GOOD	
	F-Wt.	B- & C-Wt.	F-Wt.	E-Wt.	B-Wt.	B-Wt.	B-Wt.	C-Wt.	B-Wt.
NORTON	Norton SG H920	Dry Ice A975	BlueFire H822	BlueFire H875P	Adalox A275	Adalox A270	Durite A475	Adalox A290	PB273
MERIT	763U, 751I	734U, 735U, 765L	–	750U, 751U, 740I, 745I	216U, 255L, 260L, 334U	210U, 268L, 360L	414N, 415N, 405N, 415U, 435U	236U	214U, 316U Red. NX
3M	CB115	–	BW 115	–	VC154-LL	VC152	PSF-LL, SF168	HCAB-LL, HC135, VC151-LL	–
Hermes	–	–	–	–	RedLine	–	–	–	WhiteLine
Indasa	–	PS36	PS20, PS21, PS22	–	PS33	–	PL35	PS33	PL36
Klingspor	–	–	–	Royal Coarse Cut	Q-Silver, Royal, Royal Micro	Silver	CaratFlex, PolarStar	Bulldog Gold, Basecut	Carat (B), Basecut
Mirka	–	1950	1820, 1919	1820, 1919	1940, 1950	–	1748	1947	–
SIA	–	–	–	KP510E, KP709	MPG	–	CP131A	KP911	MP10
VSM	–	–	–	–	–	–	–	–	–

FEATURED PRODUCTS

Light-Weight Paper Discs



NO-FIL NORTON DRYICE A975

BEST CHOICE FOR THE MOST DEMANDING SANDING APPLICATIONS

FEATURES

BENEFITS

- | | |
|---|--|
| ■ P-graded Norton SG ceramic alumina abrasive | ■ Fastest cut rate; longest life of any paper disc |
| ■ Unique fiber-reinforced, flexible B- and C-weight latex-saturated backing | ■ 50-60% improvement in tear strength, longer life in all applications |
| ■ Water-based No-Fil stearate, non-pigmented | ■ Flexible |
| ■ NEW Multi-Air Cyclonic A975 Hook and Loop Discs now available | ■ Provides maximum load resistance and extended life |
| | ■ No color transfer |
| | ■ Revolutionary desing for maximum vacuum assist (see page 87 for more details and product availability) |



NO-FIL NORTON ADALOX A275

BETTER CHOICE FOR HIGH-PERFORMANCE DRY FINISHING ON ALL MATERIALS

FEATURES

BENEFITS

- | | |
|---|--|
| ■ Premium P-graded, heat-treated aluminum oxide abrasive | ■ Superior life, fast cut rate, consistent finish |
| ■ Unique fiber-reinforced, flexible B-weight latex-saturated backing | ■ 50-60% improvement in tear strength |
| ■ Water-based stearate, non-pigmented, No-Fil coating | ■ Flexible |
| ■ 5" and 6" individual PSA discs in fine grits have a tabbed, white translucent liner | ■ Provides maximum load resistance and extended life |
| | ■ No color transfer to work |
| | ■ The PSA adhesive is protected from airborne contaminants |
| | ■ The tab allows easier removal of the paper liner |



NO-FIL NORTON DURITE A475

BETTER CHOICE FOR HARD-TO-SAND SURFACES AND WOOD APPLICATIONS

FEATURES

BENEFITS

- | | |
|---|---|
| ■ P-graded, hard, silicon carbide abrasive | ■ Easy penetration of the hardest surfaces |
| ■ Water-based stearate, non-pigmented, No-Fil coating | ■ Resists loading for the longest usable product life |
| ■ Durable, fiber-reinforced, B-weight latex paper | ■ No color transfer to work |
| | ■ Provides flexibility and resistance to tearing |



MERIT NO-LOAD PB273

GOOD CHOICE FOR SANDING PAINT, PRIMER, PLASTICS, FIBERGLASS, AND WHITEWOOD AT A LOW INITIAL PRICE

FEATURES

BENEFITS

- | | |
|---|---|
| ■ P-graded, aluminum oxide abrasive | ■ Fast cutting action and extended life with consistent finish |
| ■ Flexible latex B-weight backing, with a full resin bond and open coat | ■ Improved resistance to delamination; no delamination to back-up pad |
| ■ Water-based stearate, non-pigmented, No-Fil coating | ■ Provides improved load resistance |
| | ■ No color transfer to work |



FEATURED PRODUCTS

Heavy-Weight Paper Discs



NORTON SG H920

BEST CHOICE FOR MORE DEMANDING STOCK REMOVAL APPLICATIONS

FEATURES

- Durable and friable Norton SG ceramic alumina abrasive
- Strong, heavy F-weight paper, synthetically-coated

BENEFITS

- Maximum life; fast aggressive cutting action, yet cool cutting
- Maximum durability and chip resistance, ideal for soldered and welded areas, and unpainted metal applications



NORTON BLUEFIRE H875P

BETTER CHOICE FOR SOFT MATERIAL APPLICATIONS

FEATURES

- Next-generation zirconia alumina abrasive
- Strong, heavy, E-weight paper
- Open coat design

BENEFITS

- Extended life over original zirconia alumina products
- Improved cut rate
- Increased durability and chip resistance, flexible
- Reduced loading; ideal for body-filler, fiberglass and composites

AVAILABILITY
STICK AND SAND (PSA)
HEAVY-WEIGHT DISC ROLLS
NON-VACUUM



TIER:

BEST

BETTER

BETTER

BRAND:

Norton

Norton

Norton

CAP CODE:

H920

H822

H875P

ABRASIVE:

Ceramic Alumina

Zirconia Alumina

Zirconia Alumina

PAPER BACKING WEIGHT:

F-Weight

F-Weight

E-Weight

SIZE	GRIT	ROLLS/STD. PKG.	DISCS/ ROLL	PART #	PART #	PART #
5	60	4	100	66261149873	66261137310	
	80	4	100	66261149872	66261137309	66261124977
	100	4	100	66261149871	66261137308	
	120	4	100	66261149870	66261137307	
6	60	4	100		66261137323	
	80	4	100	66261149876	66261137322	66261125573
	120	4	100	66261149874		
8	100	4	50	66261149879		
	120	4	50		66261137333	

Refer to the end of this section for back-up pads and accessories.



AVAILABILITY
STICK AND SAND (PSA)
LIGHT-WEIGHT DISC ROLLS
NON-VACUUM



TIER:	BEST	BETTER	BETTER	GOOD	GOOD
BRAND:	Norton	Norton	Norton	Norton	Merit
CAP CODE:	A975 NO-FIL	A275 NO-FIL	A475 NO-FIL	A290 NO-FIL	PB273 NO-LOAD
ABRASIVE:	Ceramic Alumina	Aluminum Oxide	Silicon Carbide	Aluminum Oxide	Aluminum Oxide
PAPER BACKING WEIGHT:	B- & C-Weight	B-Weight	B-Weight	C-Weight	B-Weight
OTHER:	P-Graded	P-Graded	P-Graded	P-Graded	P-Graded

SIZE	GRIT	ROLLS/ STD. PKG.	DISCS/ ROLL	PART #	PART #	PART #	PART #	PART #
3-1/2	80	4	100		66261136376			
	120	4	100		66261136375			
	180	4	100		66261136373			
	220	4	100		66261136372			
	280	4	100		66261136370			
	320	4	100		66261136369			
	400	4	100		66261136368			
5	60	4	100				66261149831	
	80	4	100	66261140502	66261131464*	66254487415	66261149830	66623362930
	100	4	100	66261140501	66261131463*	66254487417	66261149829	
	120	4	100	66261140500	66261131462*	66254487418	66261149828	66623362929
	150	4	100	66261140499	66261131461*	66254487440	66261149827	66623362928
	180	4	100	66261140498	66261131460*	66254487441	66261149826	66623362927
	220	4	100	66261142474	66261131459*	66254487442	66261149825	66623362926
	240	4	100	66261155380	66261131458*	66254487443	66261149824	66623362925
	280	4	100	66261155379	66261131457*		66261149823	
	320	4	100	66261155378	66261131456*	66254487444	66261149822	66623362924
	400	4	100	66261155377	66261131454*	66261065293	66261149821	66623362923
	500	4	100	66254480231	66261131453*			
	600	4	100	66623305608	66261131452*	66254421217		66623362922
	800	4	100	66254480230	66261131451*	66254401221		66623362921
6	60	4	100				66261149847	
	80	4	100	66261140512	66261131481*	66254487446	66261149842	66623362940
	100	4	100	66261140511	66261131480*		66261149841	69957352447
	120	4	100	66261140510	66261131479*	66254487447	66261149840	66623362939
	150	4	100	66261140509	66261131478*		66261149839	66623362938
	180	4	100	66261140508	66261131477*	66254487448	66261149838	66623362937
	220	4	100	66261148340	66261131476*	66254487449	66261149837	66623362936
	240	4	100	66261155376	66261131475*		66261149836	66623362935
	280	4	100	66261155375	66261131474*		66261149835	
	320	4	100	66261155374	66261131473*	66254487450	66261149834	66623362934
	400	4	100	66261155373	66261131471*		66261149833	66623362933
	500	4	100	63642506198	66261131470*			
	600	4	100	63642506199	66261131469*			66623362932
	800	4	100	63642506200	66261131468*			66623362931
8	80	4	100		66261131617			
	120	4	100		66261131615			
	150	4	100		66261131614			
	180	4	100		66261131613			
	320	4	100		66261131612			

* PACKAGING STANDARDS A275 = 6/100

Refer to the end of this section for back-up pads and accessories.



AVAILABILITY
STICK AND SAND (PSA)
LIGHT-WEIGHT DISC ROLLS
VACUUM



TIER: **BETTER**

BRAND: Norton

CAP CODE: **A275 NO-FIL**

ABRASIVE: Aluminum Oxide

PAPER BACKING WEIGHT: B-Weight

OTHER: P-Graded

GOOD

Norton

A290 NO-FIL

Aluminum Oxide

C-Weight

P-Graded

SIZE	GRIT	ROLLS/STD. PKG.	DISCS/ROLL	PART #	ROLLS/STD. PKG.	DISCS/ROLL	PART #		
				 5 IN. X 5 HOLE DIE #3329					 5 IN. X 5 HOLE DIE #3329
5"	60				4	100	66261130266		
	80	6	100	66261131498	4	100	66261130265		
	100	6	100	66261131497	4	100	66261130264		
	120	6	100	66261131496	4	100	66261130263		
	150	6	100	66261131495	4	100	66261130262		
	180	6	100	66261131494	4	100	66261130261		
	220	6	100	66261131493	4	100	66261130260		
	240	6	100	66261131492	4	100	66261130259		
	320	6	100	66261131490	4	100	66261130258		
	400	6	100	66261131488					
500	6	100	66261131487						
				 6 IN. X 6 HOLE DIE #3333					 6 IN. X 6 HOLE DIE #3333
6"	80	6	100	66261131515	4	100	66261130276		
	100	6	100	66261131514	4	100	66261130275		
	120	6	100	66261131513	4	100	66261130274		
	150	6	100	66261131512	4	100	66261130273		
	180	6	100	66261131511	4	100	66261130272		
	220	6	100	66261131510	4	100	66261130271		
	240	6	100	66261131509					
	280	6	100	66261131508					
	320	6	100	66261131507	4	100	66261130268		
	400	6	100	66261131505					
600	6	100	66261131503						

Refer to the end of this section for back-up pads and accessories.



PSA Disc Roll Dispenser

- Norton disc roll dispensers feature heavy-duty construction and a rubberized finish to protect your product, as well as the finish on your workpiece
- These versatile dispensers are designed to accommodate any 5" or 6" disc roll or sheet roll
- They can be attached to a wall or stacked for multi-grit or multi-diameter operations
- Discs are individually dispensed and removed from the roll by a cutter bar

DESCRIPTION	STD. PKG.	PART NO
PSA Disc Roll Dispenser		
Single Disc Roll Dispenser	1	63642542772
Double Disc Roll Dispenser (shown)	1	63642502981



**AVAILABILITY
STICK AND SAND
(PSA) INDIVIDUAL
DISCS**

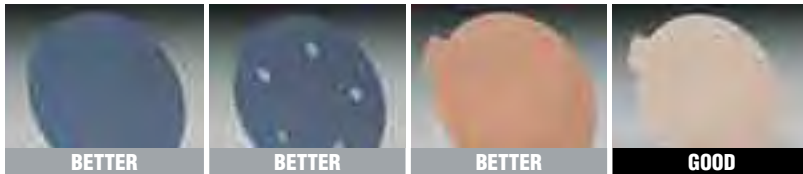

TIER:	BETTER	BETTER	BETTER	GOOD
BRAND:	Norton	Norton	Norton	Merit
CAP CODE:	H875P	H875P	A275 NO-FIL	PB273 NO-LOAD
ABRASIVE:	Zirconia Alumina	Zirconia Alumina	Aluminum Oxide	Aluminum Oxide
PAPER BACKING WEIGHT:	E-Weight	E-Weight	B-Weight	B-Weight
FASTENING:	PSA	PSA Vacuum	PSA Tabbed	PSA Tabbed
OTHER:			P-Graded	P-Graded

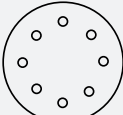
SIZE	GRIT	MIN./ STD PKG.	PART #	PART #	PART #	PART #
5"	36	50/200	66261125436			
	40	50/200	66261125307			
	80	50/200	66261125244			69957348198‡
	100	100/400				69957348200
	120	100/400				69957348201
	150	100/400				69957348202
	180	100/400				69957348203
	220	100/400				69957348204
	240	100/400				
	320	100/400				69957348206
	400	100/400				
	600	100/400				69957348223
	800	100/400				
	1000	100/400			66261131450	
1200	100/400			66261131449		
				 6" X 6 HOLE DIE #3371		
6"	36	50/200	66261123575			
	40	50/200	66261123574	66261123580		
	80	50/200	66261123573			
	1000	100/400			66261131467	
	1200	100/400			66261131466	
	1500	100/400			66261131465	
				 8" X 8 HOLE DIE #3370		
8"	36	25/100	66261123578	66261123584		
	40	25/100	66261123577			
	80	25/100	66261123576	66261123582		

PACKAGING STANDARDS:
MIN. / STD. PKG.
‡ PB273 = 100/400

Refer to the end of this section for back-up pads and accessories.



FEATURED PRODUCTS



MULTI-AIR CYCLONIC HOOK AND LOOP VACUUM

LESS DUST; MORE PRODUCTIVITY

FEATURES

- Precision laser-cut, spiral-hole design based on the Golden Ratio
- Norton SG ceramic alumina grain
- Unique fiber-reinforced latex/paper backing
- Water-based stearate coating (No-Fil)

BENEFITS

- Maximum dust extraction for cleaner work environment and less potential for contamination
- Consistent cut throughout the life of the disc
- Superior cut on difficult to sand surfaces
- Substantially longer life and faster cut than conventional abrasives
- Quick/cool cut
- Flexible, strong and tear resistant
- Load resistant for extended product life

AVAILABILITY

TIER:	BEST	NEW
BRAND:	Norton	
CAP CODE:	A975 NO-FIL	
ABRASIVE:	Ceramic Alumina	
PAPER BACKING WEIGHT:	B- & C-Weight	
OTHER:	P-Graded	

SIZE	GRIT	MIN./STD PKG.	PART #
5" x 11/16"	80	50/200	77696007745
	120	50/200	77696007753
	150	50/200	77696007755
	180	50/200	77696007756
	220	50/200	77696007757
	240	50/200	77696007760
	280	50/200	77696007762
	320	50/200	77696007763
	400	50/200	77696007765
	500	50/200	77696007768
6" x 11/16"	80	50/200	77696007770
	120	50/200	77696007773
	150	50/200	77696007774
	180	50/200	77696007775
	220	50/200	77696007776
	240	50/200	77696007777
	280	50/200	77696007778
	320	50/200	77696007781
	400	50/200	77696007784
	500	50/200	77696007785
600	50/200	77696007786	
800	50/200	77696007787	
1000	50/200	77696007788	



Refer to the end of this section for back-up pads and accessories for Norton Multi-Air Cyclonic Discs.

Improved Dust Extraction / Increased Productivity

The upgrade to precise, flat, laser-cut holes instead of die-punched holes, dramatically increases surface area contact allowing Multi-Air Cyclonic discs to improve productivity by 32% versus conventional multi-hole sanding and by 60% versus non-vacuum sanding.

The end result is more holes for dust extraction, more abrasive coverage for a better cut and no deformation – for full surface contact utilizing all the cutting power of the premium ceramic grain.

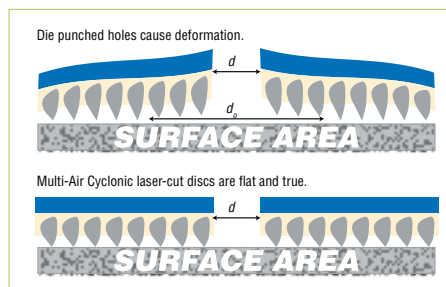



AVAILABILITY
HOOK AND LOOP
INDIVIDUAL DISCS
NON-VACUUM

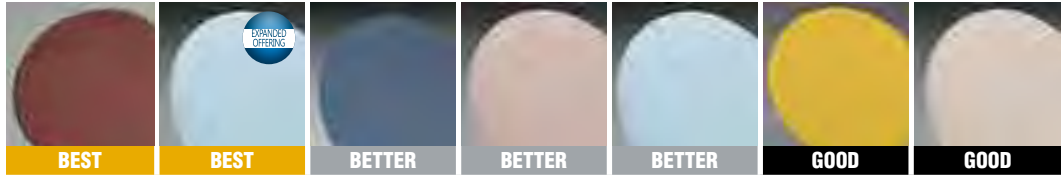

TIER:	BEST	BEST	BETTER	BETTER	BETTER	GOOD	GOOD
BRAND:	Norton	Norton	Norton	Norton	Norton	Norton	Merit
CAP CODE:	H920	A975 NO-FIL	H875P	A275 NO-FIL	A475 NO-FIL	A290 NO-FIL	PB273 NO-LOAD
ABRASIVE:	Ceramic Alumina	Ceramic Alumina	Zirconia Alumina	Aluminum Oxide	Silicon Carbide	Aluminum Oxide	Aluminum Oxide
PAPER BACKING WEIGHT:	F-Weight	B- & C-Weight	E-Weight	B-Weight	B-Weight	C-Weight	B-Weight
OTHER:		P-Graded		P-Graded	P-Graded	P-Graded	P-Graded

SIZE	GRIT	MIN./STD PKG.	PART #	PART #	PART #	PART #	PART #	PART #	PART #
3"	80	50/200		63642505990		66261131532			
	100	50/200				66261144926			
	120	50/200		63642505991		66261128688			
	150	50/200		63642505992		66261140385			
	180	50/200		63642505993		66261131528			
	220	50/200		63642505994		66261131527			
	240	50/200		63642505995		66261131526			
	320	50/200		63642505996		66261131524			
	400	50/200		63642505997		66261136995			
	500	50/200		63642505998		66261131521			
	600	50/200		63642505999		66261136996			
	800	50/200		63642506000		66261131519			
	1000	50/200		63642506001		66261135900			
	1200	50/200							
1500	50/200		63642506002		66261147434				
5"	40	25/100			66261125684				
	60	100/400	66261149864*					66261130224	
	80	100/400	66261149865*	66261140522‡	66261125444•	66261131549		66261149907	66623362950
	100	100/400	66261149866*	66261140521‡		66261131548		66261149906	66623365788
	120	100/400	66261149867*	66261140520‡		66261131547		66261149905	66623362949
	150	100/400		66261140519‡		66261131546		66261149904	66623362948
	180	100/400		66261140518‡		66261131545		66261149903	66623362947
	220	100/400		66261149541‡		66261131544		66261149902	66623362946
	240	100/400		66261149540‡		66261131543			66623362945
	280	100/400				66261131542			
	320	100/400		66261149538‡		66261131541		66261149900	66623362944
	400	100/400		66261149537‡		66261131539	66261052270	66261149899	66623362943
	500	100/400		66254480233‡		66261131538			
	600	100/400				66261131537	66254421221		66623362942
	800	100/400		66254480232‡		66261131536	66261052267		66623362941
	1000	100/400				66261131535	66261052254		
1200	100/400				66261131534				
1500	100/400				66261131533				
6"	36	25/100			66261123590				
	40	25/100			66261123589				
	80	100/400		66261140532‡	66261123588•	66261131566		66261149916	66623362960
	100	100/400		66261140531‡		66261131565		66261149915	66623365789
	120	100/400		66261140530‡		66261131564		66261149914	66623362959
	150	100/400		66261140529‡		66261131563		66261149913	66623362958
	180	100/400		66261140528‡		66261131562		66261149912	66623362957
	220	100/400		66261149546‡		66261131561		66261149911	66623362956
	240	100/400				66261131560			66623362955
	280	100/400				66261131559		66261149910	
	320	100/400		66261149543‡		66261131558		66261149909	66623362954
	400	100/400		66261149542‡		66261131556		66261149908	66623362953
	500	100/400		63642506202‡		66261131555			
	600	100/400		63642506203‡		66261131554			66623362952
	800	100/400		63642506204‡		66261131553	66261052268		66623362951
	1000	100/400		63642506375‡		66261131552	66261052255		
1200	100/400		63642506376‡		66261131551				
1500	100/400		63642506377‡		66261131550				
8"	36	25/100			66261123593				
	40	25/100			66261123592				
	60	50/250							
	80	50/250			66261123591•				
	100	50/250							
	120	100/400				66261131662			
	180	100/400				66261131661			











PACKAGING STANDARDS: MIN. / STD. PKG.
 * H920 = 50/250
 † A975 = 50/200
 ‡ H875P = 25/100

Refer to the end of this section for back-up pads and accessories.

**AVAILABILITY
HOOK AND LOOP
INDIVIDUAL DISCS
VACUUM**



TIER:	BEST	BETTER	BETTER	GOOD	GOOD	GOOD
BRAND:	Norton	Norton	Norton	Norton	Norton	Merit
CAP CODE:	A975 NO-FIL	H875P	A275 NO-FIL	A290 NO-FIL	A290 NO-FIL	PB273 NO-LOAD
ABRASIVE:	Ceramic Alumina	Zirconia Alumina	Aluminum Oxide	Aluminum Oxide	Aluminum Oxide	Aluminum Oxide
PAPER BACKING WEIGHT:	B- & C-Weight	E-Weight	B-Weight	C-Weight	C-Weight	B-Weight
OTHER:	P-Graded		P-Graded	P-Graded	P-Graded	P-Graded

SIZE	GRIT	MIN./ STD PKG.	PART #	PART #	PART #	PART #	PART #	PART #
								
5	60	100/400						
	80	100/400	66261140517‡		66261131583	66261130236‡	66261130245‡	66623366071
	100	100/400			66261131582	66261130234‡	66261130243‡	
	120	100/400	66261140515‡		66261131581	66261130233‡	66261130242‡	66623369778
	150	100/400			66261131580	66261130232‡	66261130241‡	66623366073
	180	100/400			66261131579	66261130231‡	66261130240‡	66623366074
	220	100/400			66261131578	66261130230‡	66261130239‡	66623366075
	240	100/400			66261131577			
	320	100/400			66261131575	66261130227‡	66261130238‡	66623366077
	400	100/400			66261131573	66261130226‡		
	600	100/400			66261131571			
								
6	80	100/400						
	100	100/400	66261140527‡		66261131600	66261130255‡		66623367394
	120	100/400			66261131599			
	150	100/400			66261131598	66261130253‡		66623367397
	180	100/400			66261131597			66623367398
	220	100/400			66261131596	66261130251‡		66623367399
	280	100/400			66261131595	66261130250‡		
	320	100/400	66261149553‡		66261131593			66623367400
	400	100/400			66261131592			66623367401
	600	100/400			66261131590			
	800	100/400			66261131588			
	1000	100/400			66261131587			
	1200	100/400			66261131586			
	1500	100/400			66261131585			
					66261131584			
								
8	36	25/100						
	80	25/100			66261123598			
					66261123596			

PACKAGING STANDARDS: ‡ A975, A975 VACUUM, A290 VACUUM = 50/200



For Fein/Festo Sanders

High-performance abrasives for high performance sanders. Now available: No-Fil Norton Drylce A975 discs with center vacuum hole for Fein and Festo random orbital sanders.

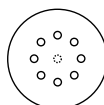

6 IN. X 9 HOLE
DIE #3408-2

TIER:	BEST
BRAND:	Norton
CAP CODE:	A975 NO-FIL
ABRASIVE:	Ceramic Alumina
PAPER BACKING WEIGHT:	B- & C-Weight
OTHER:	P-Graded

SIZE	GRIT	STD. PKG.	PART #
6	80	50/200	07660705489
	100	50/200	07660705488
	120	50/200	07660705487
	150	50/200	07660705486
	220	50/200	07660705484



Multi-Air Foam Interface Pads

- Designed for use with fine grit Multi-Air Cyclonic Hook and Loop sanding discs to improve both surface finish and cut rate
- Use with Multi-Air Hook & Loop Disc Back-Up Pads
- Align the interface pad with the Multi-Air back up pad then simply attach the disc to the interface pad because the holes do not have to be lined up.

DESCRIPTION	STD. PKG.	PART #
Multi-Air Foam Interface Pads		
5" Diameter x 1/2" Thick Pad	8	63642585864
6" Diameter x 1/2" Thick Pad	12	07660719359



Multi-Air Hook & Loop Back-up Pads with Vacuum Holes

- Innovative design optimized for maximum air flow and powerful dust extraction
- Pads are engineered with a durable urethane foam, heat-resistant plastic, a molded-in 5/16"-24 spindle, and hooked face.
- Holes in the disc do not have to be matched up with the holes in the pad, so changeover is fast and easy.

DESCRIPTION	MAX. RPM	STD. PKG.	PART #
Multi-Air Hook & Loop Back-Up Pads with Vacuum Holes			
5" (125mm) with 5/16"-24 Shank, Medium-Density Urethane Pad	15,000	5	66623376000
6" (150mm) with 5/16"-24 Shank, Medium-Density Urethane Pad	15,000	5	63642506160



Low-Profile Pads for Dual Action / Random Orbital Sanders

- Soft density low-profile pads utilize 1/2" thick foam for fine finish sanding and offer moderate conformability
- Medium low-profile pads have 1/2" thick urethane foam for intermediate and finish sanding
- Available with PSA or hook and loop faces; both designs are shock resistant and have a fiberglass backing plate with a riveted 5/16"-24 threaded shank for added strength and increased heat resistance
- Available with standard hole patterns for vacuum-assist sanding

DESCRIPTION	MAX. RPM	STD. PKG.	PART #
Low Profile Pads for DA/Random orbital Sanders			
3" Hook & Loop Soft Low-Profile	12,000	10*	63642506128
3" x 7/8" Hook & Loop Pad		10	63642541947
3-1/4 Hook & Loop Buffing Pad		5*	66261085302
5" PSA Soft Low-Profile	12,000	5*	63642506126
5" PSA Medium Low-Profile	15,000	5*	63642506131
5" PSA Medium Low-Profile with 5 vacuum holes	15,000	5*	63642506132
5" Hook & Loop Soft Low-Profile	12,000	5*	63642506129
5" Hook & Loop Medium Low-Profile	15,000	5*	63642506135
5" Hook & Loop Medium Low-Profile with 5 vacuum holes	15,000	5*	63642506136
6" PSA Soft Low-Profile	12,000	5*	63642506127
6" PSA Medium Low-Profile	15,000	5*	63642506133
6" PSA Medium Low-Profile with 6 vacuum holes	15,000	5*	63642506134
6" Hook & Loop Soft Low-Profile	12,000	5*	63642506130
6" Hook & Loop Medium Low-Profile	15,000	5*	63642506137
6" Hook & Loop Medium Low-Profile with 6 vacuum holes	15,000	5*	63642506138
8" Hook & Loop Medium Low-Profile with 8 vacuum holes, 5 screw	1,500	5*	63642543712
8" Hook & Loop Medium Low-Profile with 8 vacuum holes, 6 screw	1,500	5*	63642543714

* PACKED IN INDIVIDUAL CLAMSHELL



Tapered Pads for Dual Action / Random Orbital Sanders

- Designed with medium density polyurethane foam and a tapered edge for conformability, these pads are firm enough for flat surfaces, yet soft enough for severe curves and contours
- Available with either PSA (vinyl) or hook and loop faces in vacuum or non-vacuum
- The 5" and 6" pads are shock resistant and have a fiberglass backing plate with a riveted 5/16"-24 threaded shank for use on random orbital or dual action sanders
- The 8" pads have a 5/8"-11 threaded female hub

DESCRIPTION	MAX. RPM	STD. PKG.	PART #
Tapered Pads for DA/Random Orbital Sanders			
5" PSA Medium Tapered	15,000	5*	63642506139
5" PSA Medium Tapered with 5 vacuum holes	15,000	5*	63642506140
5" Hook & Loop Medium Tapered	15,000	5*	63642506143
5" Hook & Loop Medium Tapered with 5 vacuum holes	15,000	5*	63642506144
6" PSA Medium Tapered	15,000	5*	63642506141
6" PSA Medium Tapered with 6 vacuum holes	15,000	5*	63642506142
6" Hook & Loop Medium Tapered	15,000	5*	63642506145
6" Hook & Loop Medium Tapered with 6 vacuum holes	15,000	5*	63642506146
8" PSA Medium Tapered	6,000	5*	63642543112
8" Hook & Loop Medium Tapered	3,200	5*	63642543704

* PACKED IN INDIVIDUAL CLAMSHELL



Hook & Loop Foam Interface Pads

- Designed for use with our fine grit hook and loop sanding discs
- Improve both surface finish and cut rate
- Use with hook and loop back-up pads

DESCRIPTION	STD. PKG.	PART #
Foam Hook & Loop Interface Pads		
3" Diameter, 1/2" Thick Interface	10	63642505457
6" Diameter, 1/2" Thick Interface	5	63642542089
5" Diameter, 3/4" Thick Interface	2	63642502161
6" Diameter, 3/4" Thick Interface	2	63642502162



Half Moon Hand Pad

- The unique half moon pad uses a standard 5" hook and loop disc folded in half, which adheres to the hooks on the pad face
- The straight edge of the pad allows the operator to sand corners, contours, narrow crevices and minute imperfections without over-sanding

DESCRIPTION	STD. PKG.	PART #
Half Moon Hand Pad		
5" Hook and Loop	10	63642502768



Polishing Adapter Pad

- Converts your standard hook and loop pad into a soft polishing pad
- The foam adapter is 3/8" thick and is excellent for fine grits where minimal removal is required
- It is ideal for either flat or contour surfaces

DESCRIPTION	MAX. RPM	STD. PKG.	PART #
Polishing Adapter Pad			
5" Hook and Loop Adapter Pad	3,786	10	63642503121



Ergonomic Hand Sanders

- The ergonomic palm sander is uniquely designed to be user-friendly, with finger indentations for the operator
- It quickly converts standard 5" and 6" hook and loop discs into hand sanders for finishing flat surfaces

DESCRIPTION	STD. PKG.	PART #
Ergonomic Hand Sander		
5" Hook and Loop	5	63642503147
6" Hook and Loop	5	63642503726



Disc Hand Pads

- Hand pads eliminate finger sanding
- The ultra-thin 3/16" thick pad is composed of a single layer of neoprene foam and is designed for maximum flexibility – producing excellent finishes
- The 1" thick pad is composed of two layers, neoprene and polyester foam, for excellent conformability and softness, resulting in fine finishes
- Each pad has an elastic hand strap to hold it firmly in place.
- Available with either PSA (vinyl) faces or hook and loop face

DESCRIPTION	STD. PKG.	PART #
Disc Hand Pads		
5" x 3/16" Thick Soft Foam PSA	10	63642503111
5" x 1" Thick Soft Foam PSA	10	63642502842
5" x 1" Thick Soft Foam Hook and Loop	10	63642503117



Panel and Adhesive Cleaner

- Removes adhesives, tar, grease, wax, body sealers, undercoating sprays, and silicone from most surfaces
- Aggressive cleaner is safe to use on most paint applications
- Packaged with squirt dispenser
- Use as directed

DESCRIPTION	STD. PKG.	PART #
Panel and Adhesive Cleaner		
Quart Can	12	07660782780



CATEGORY DEFINITION

For use on random orbital and rotary sanders. The industry's highest performing film and foam finishing discs are engineered for composite, automotive, and other fine finishing applications. Norton microfinishing film discs produce superior finishes dry without sacrificing cut rate while Norton foam finishing discs are used moist to produce a semi-polished surface to reduce buffing time.

- APPLICATIONS:** Film discs: final dry finishing of primed and painted surfaces, varnishes, composites, and gel coats before buffing
 Foam finishing discs: final moist finishing of clear coat, varnishes, composites, and gel coats before buffing
 Compounds and buffing pads: removes swirl marks and sand scratches
- SIZE RANGE:** 3", 5" and 6"
- GRIT RANGE:** Film Discs: P800-P1500
 Foam Discs: P1500, P2000, P3000

FEATURED PRODUCTS



NORTON PURE ICE FINISHING FILM Q175

BEST CHOICE FOR FINAL DRY FINISHING OF PRIMED AND PAINTED SURFACES, VARNISHES, COMPOSITES, AND GEL COATS

- | FEATURES | BENEFITS |
|--|--|
| ■ White aluminum oxide grain and new patented resin system | ■ Better life, cut rate, and finish |
| ■ 3 mil polyester backing | ■ Better flexibility and flatness of discs |
| ■ Hook and loop attachment system | ■ Quick, easy mounting and removal |
| ■ Color-coded backprint by grit size | ■ Easy grit identification |



NORTON ICE FINISHING FOAM Q255

BEST CHOICE FOR MOIST FINISHING OF CLEAR COATS, VARNISHES, COMPOSITES, AND GEL COATS

- | FEATURES | BENEFITS |
|-----------------------------------|---|
| ■ Integrated foam backing | ■ Eliminate pigtails and costly re-work |
| ■ Open mesh design | ■ Conformable to contours |
| ■ Produces a semi-polished finish | ■ Equal pressure distribution for quicker sanding |
| | ■ Uniform scratch pattern |
| | ■ Quick and easy to buff out |

AVAILABILITY

		 BEST TIER: Norton BRAND: PURE ICE Q175 TRADENAME: Aluminum Oxide ABRASIVE: 3 mil Polyester Film BACKING WEIGHT: P-Graded OTHER:			 BEST TIER: Norton BRAND: ICE Q255 TRADENAME: Aluminum Oxide ABRASIVE: Foam BACKING WEIGHT: P-Graded OTHER:	
SIZE	GRIT	COLOR	MIN./STD. PKG.	PART #	MIN./STD. PKG.	PART #
3	P800	Black	50/200	77696088701	6/24 6/24	63642506022 63642506020
	P1000	Red	50/200	77696088702		
	P1200	Green	50/200	77696088703		
	P1500	Blue	50/200	77696088704		
	P3000	Green	50/200	77696088710		
5	P800	Black	50/200	77696088707		
	P1000	Red	50/200	77696088708		
	P1200	Green	50/200	77696088709		
	P1500	Blue	50/200	77696088710		
6	P800	Black	50/200	77696088713	15/60 15/60 15/60	63642506015 63642506014 63642506013
	P1000	Red	50/200	77696088714		
	P1200	Green	50/200	77696088715		
	P1500	Blue	50/200	77696088716		
	P2000	Magenta	50/200			
	P3000	Green	50/200			

Refer to the following page for back-up pads and accessories.



Norton Liquid Ice Extra-Cut Compound

- Water soluble; easy to use and easy to clean up
- Engineered to be used with a selection of 3 pads, depending on the finish required.

DESCRIPTION	STD. PKG.	STD. CASE	PART #
Quart – Norton Liquid Ice Extra-Cut Compound	1	4	63642597116



Norton Liquid Ice Clean-up/Detailer Spray

- The spray detailer easily cleans up excess buffing residue and produces paint protection
- Spray it on and wipe off with a Norton Microfiber cloth (see page 212)

DESCRIPTION	STD. PKG.	STD. CASE	PART #
32 oz. Spray Bottle Clean-up Detailer	1	4	63642542082



Norton Liquid Ice Ultra-Fine Machine Glaze

- Use on its own for fine scratch removal or as Step 3 in place of Norton Liquid Ice Extra-Cut to eliminate swirl marks and produce a high gloss finish
- Ideal for dark-colored vehicles

DESCRIPTION	STD. PKG.	STD. CASE	PART #
Quart – Norton Liquid Ice Ultra-Fine Machine Glaze	1	4	63642506092



8" Hook and Loop Buffing/Polishing Waffle Pads

- These pads can be used with Norton Liquid Ice Extra-Cut.

DESCRIPTION	STD. PKG.	STD. CASE	PART #
8" Orange Waffle Foam pad - Step 1	1	6	63642506379
8" Blue Waffle Foam Pad - Step 2	1	6	63642506380
8" White Waffle Foam Pad - Step 3	1	6	63642506381



8" and 9" Hook and Loop Buffing/Polishing Pads

- These pads can be used with Norton Liquid Ice Extra-Cut following the step numbers

DESCRIPTION	STD. PKG.	STD. CASE	PART #
8" Super Cut Wool Pad - Step 1	1	6	63642542077
9" Blue Cutting Foam Pad - Step 2	1	6	63642542078
9" White Finishing Foam Pad - Step 3	1	6	63642542079



3" Hook and Loop Buffing/Polishing Pads

- For small spot repair.

DESCRIPTION	STD. PKG.	STD. CASE	PART #
3" Super Cut Wool Pad - Step 1	10	40	63642543832
3" Blue Cutting Foam Pad - Step 2	10	40	63642505459
3" White Finishing Foam Pad - Step 3	10	40	63642505460



Black Lambswool Hook and Loop Polishing Pads

- Distributing and applying material evenly and consistently, these dense, durable, lambswool pads are designed to repair clearcoat finishes.

DESCRIPTION	STD. CASE	PART #
3" Pad with Loop – 3/4" nap	40	63642503670
4" Pad with Loop – 3/4" nap	250	63642503671



Low-Profile Back-up Pads for Dual Action / Random Orbital Sanders

- Soft density low-profile pads utilize 1/2" thick foam for fine finish
- Shock-resistant and have a fiberglass backing plate with a riveted 5/16"-24 threaded shank for added strength/increased heat resistance.

DESCRIPTION	MAX. RPM	STD. CASE	PART #
3" Hook and Loop Soft Low-Profile	12,000	10	63642506128
6" Hook and Loop Soft Low-Profile	12,000	5	63642506130



Hook and Loop Back-up Pads for 8" and 9" Buffing Pads

- Black plastic back-up plate with hook and loop face. Moulded in 5/8"-11 threaded female hub.

DESCRIPTION	STD. PKG.	STD. CASE	PART #
8" and 9" Hook and Look Back-up Pad	1	3	63642542080



CATEGORY DEFINITION

Norton PSA (pressure sensitive adhesive) individual cloth discs and disc rolls are used on three different types of machines and the application changes depending on which two they are used on.

- APPLICATIONS:** Electric Random Orbital Sanders – for use on contours or flat surfaces for light- to medium-pressure grinding, blending, leveling, and finishing applications
 Stationary Disc Sanders – used in woodworking and metalworking for stock removal, sanding/grinding flat surfaces, dimensioning and finishing
- SIZE RANGE:** 5" – 24" diameter
- GRIT RANGE:** 24 – 320
- ABRASIVE GRAIN:** Ceramic Alumina, Zirconia Alumina, Aluminum Oxide
- BACK-UP PADS:** Rubber, with hardness variations for different applications, for portable machines. Steel for stationary disc sanders

FEATURED PRODUCTS



NORTON BLAZE R980P

BEST CHOICE FOR ALL HARD-TO-GRIND HIGH ALLOY STEELS

FEATURES

- Norton SG ceramic alumina abrasive
- Durable resin bond
- Self-lubricating supersize treatment
- Strong Y-weight polyester backing

BENEFITS

- Coolest cut; significantly faster cut rate
- Better grain adhesion, edge-fray resistance
- Cool cut on harder-to-grind materials
- Long life and consistent cut



NORTON BLUEFIRE R821P

BETTER CHOICE FOR GRINDING AND DEBURRING STAINLESS STEEL

FEATURES

- Self-sharpening, zirconia alumina abrasive
- Heavy Y-weight backing

BENEFITS

- Cooler cut, extended life over aluminum oxide discs
- Durable; reduced edge wear



NORTON METALITE R228

GOOD CHOICE FOR GENERAL PURPOSE METALWORKING

FEATURES

- Premium aluminum oxide abrasive
- Heavy X-weight backing

BENEFITS

- Long life
- Durable
- Ideal for aggressive stock removal applications
- Resistant to heat



Cloth PSA Discs for Random Orbital Sanders

AVAILABILITY

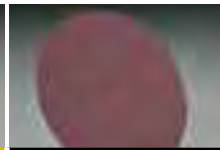

TIER:

BEST

GOOD

GOOD

BRAND:

Norton

Norton

Norton

TRADENAME:

BLAZE R980P

METALITE R228

METALITE R228

ABRASIVE:

Ceramic Alumina

Aluminum Oxide

Aluminum Oxide

ATTACHMENT

PSA Discs

PSA Discs

PSA Discs Roll

SIZE (D)	GRIT	MIN./ STD. PKG.	PART #	PART #	ROLLS/PKG / DISCS/ROLL	PART #
5	36	50/250	66254461506	66261136589		
	40	50/250	66254461507	66261136588		
	50	50/250	66254461508	66261136587	4/100	66261133252
	60	50/250	66254461509	66261136586	4/100	66261133253
	80	50/250	66254461510	66261136585	4/100	66261133254
	100	50/250		66261136584		
	120	50/250	66254461512	66261136583		
	150	50/250		66261136582		
	180	50/250		66261136581		
6	60	50/250		66261136596		
	80	50/250		66261136595		
	100	50/250		66261136594		
	120	50/250		66261136593		
8	180	50/250		66261136592		
	36	50/250		66261136350		
	40	50/250		66261136351		
	50	50/250		66261136352		
	60	50/250		66261136576		
80	50/250		66261136354			
120	50/250		66261136355			

Back-up Pads for Cloth PSA Discs

DESCRIPTION	MAX. RPM	STD. PKG.	PART #
Back-up Pads for Cloth PSA Discs			
5" Diameter – Low Profile – Soft	12,000	5	63642506126
5" Diameter – Low Profile – Medium	12,000	5	63642506131
5" Diameter – Tapered – Medium	12,000	5	63642506139
6" Diameter – Low Profile – Soft	10,000	5	63642506127
6" Diameter – Low Profile – Med	10,000	5	63642506133
6" Diameter – Tapered – Medium	10,000	5	63642506141
8" Diameter – Tapered – Medium	6,000	5	63642543112





Large Diameter Cloth PSA Discs

Used on stationary disc machines for dimensioning and finishing metal workpieces and woodworking. Pressure sensitive adhesive offers fast, convenient mounting. Made without center holes for full-face usage.

AVAILABILITY



TIER:	BEST	BETTER	GOOD
BRAND:	Norton	Norton	Norton
TRADENAME:	BLAZE R980P	BLUEFIRE R821P	METALITE R228
ABRASIVE:	Ceramic Alumina	Zirconia Alumina	Aluminum Oxide
ATTACHMENT:	PSA	PSA	PSA

SIZE (D)	GRIT	MIN./STD. PKG.	PART #	PART #	PART #
10	36	25/50			66261136606
	40	25/50		66261138314	66261136604
	50	25/50			66261136607
	60	25/50		66261138316	66261136602
	80	25/50		66261138317	66261136601
	100	25/50			66261136600
12	24	25/50		66261138318	
	36	25/50	66254416171	66261138319	66261136635
	40	25/50	66254416172	66261138320	66261136630
	50	25/50	66254416173	66261138321	66261136625
	60	25/50	66254416174	66261138322	66261136620
	80	25/50	66254416175	66261138323	66261136615
	100	25/50			66261136614
	120	25/50	66254416176		66261136613
15	36	25/50			66261136666
	40	25/50			66261136665
	50	25/50			66261136714
	60	25/50			66261136663
	80	25/50			66261136662
16	36	25/50			66261136700
	40	25/50			66261136685
	50	25/50		66261138333	66261136684
	60	25/50		66261138334	66261136683
	80	25/50		66261109128	66261136701
18	36	25/50			66261136720
	60	25/50			66261136696
	80	25/50			66261136723
20	36	25/50	66254416165	66261138343	66261136710
	40	25/50		66261138344	66261136709
	50	25/50	66254416167		66261136711
	60	25/50	66254416168	66261138346	66261136712
	80	25/50	66254416169		66261136706
	120	25/50	66254416170		
24	36	10/10			66261136718
	40	10/10			66261136717
	50	10/10			66261136725
	60	10/10			66261136726
	80	10/10			66261136727



CATEGORY DEFINITION

Norton flexible diamond coated discs combine the durability and aggressiveness of diamond, on a flexible backing.

APPLICATIONS: Grinding ceramic, glass, composites, carbide and ceramic coatings, fiberglass, and reinforced plastics; removing rust and scale on other materials; producing metallurgical stamps and coupons

SIZE RANGE: PSA Discs: 2" – 8"
Quick Change TR (Type III): 2" and 3"

GRIT RANGE: 60 – 1800

ABRASIVE TYPES: Diamond

BACKING COLOR: Color-coded backings for easily distinguished grit size selection

FEATURED PRODUCTS



FLEXIBLE DIAMOND COATED PSA DISCS

BETTER CHOICE FOR GRINDING GLASS, CERAMICS AND COMPOSITES, REMOVING RUST AND SCALE, AND PRODUCING METALLURGICAL STAMPS AND COUPONS

FEATURES

- Diamond
- PSA backing

BENEFITS

- Facilitates fast stock removal
- Quick and easy mounting and removal

				TIER: BETTER	
SIZE (D)	COLOR	GRIT	STD. PKG.	PRODUCT #	PART #
Flexible Diamond Coated PSA Discs					
2	Green	60	1	FDD2P60	66260308159
	Black	120	1	FDD2P120	66260307722
	Red	200	1	FDD2P200	66260307723
	Yellow	400	1	FDD2P400	66260308160
	White	800	1	FDD2P800	66260307012
5	Green	60	1	FDD5P60	66260307839
	Black	120	1	FDD5P120	66260307838
	Red	200	1	FDD5P200	66260307019
	Yellow	400	1	FDD5P400	66260307960

				TIER: BETTER	
SIZE (D)	COLOR	GRIT	STD. PKG.	PRODUCT #	PART #
Flexible Diamond Coated PSA Discs					
6	Green	60	1	FDD6P60	66260306381
	Black	120	1	FDD6P120	66260306382
	Red	200	1	FDD6P200	66260306383
	Yellow	400	1	FDD6P400	66260308161
8	Green	60	1	FDD8P60	66260306389
	Black	120	1	FDD8P120	66260306387
	Red	200	1	FDD8P200	66260306388
	Yellow	400	1	FDD8P400	66260311769
	White	800	1	FDD8P800	66260306386
	Blue	1800	1	FDD8P1800	66260306390

SEE COATED ABRASIVE CLOTH PSA DISC SECTION FOR BACK-UP PADS.



FLEXIBLE DIAMOND COATED QUICK-CHANGE TR (TYPE III) DISCS

BETTER CHOICE FOR IMPROVED CUT RATE AND FINISH ON CERAMICS, GLASS, FIBERGLASS, COMPOSITES, CARBIDE, AND OTHER TOUGH METALS AND COATINGS

FEATURES

- Unique abrasive pattern
- TR (Type III) fastener

BENEFITS

- Increased aggressiveness, durability and lower costs versus standard diamond discs
- Rapid, tool-free disc changes mean maximum grind time
- Discs stay firmly locked to back-up pad when in use

				TIER: BETTER	
SIZE (D)	COLOR	GRIT	STD. PKG.	PRODUCT #	PART #
TR (Type III) Diamond Coated Discs					
2"	Green	60	12	FDD2SL60	66260311778
	Black	120	12	FDD2SL120	66260311779
	Red	200	12	FDD2SL200	66260311780
	Yellow	400	12	FDD2SL400	66260311781
	White	800	12	FDD2SL800	66260311782

				TIER: BETTER	
SIZE (D)	COLOR	GRIT	STD. PKG.	PRODUCT #	PART #
TR (Type III) Diamond Coated Discs					
3"	Green	60	12	FDD3SL60	66260311783
	Black	120	12	FDD3SL120	66260311784
	Red	200	12	FDD3SL200	66260311785
	Yellow	400	12	FDD3SL400	66260311786
	White	800	12	FDD3SL800	66260311787

SEE COATED ABRASIVE QUICK-CHANGE DISC SECTION FOR BACK-UP PADS.



CATEGORY DEFINITION

Tool-free, twist-on and -off fastening systems make fast work of disc changes to maximize productivity by minimizing downtime.

- APPLICATIONS:** Fiber and NorKut trimmable hard plastic discs: welding, grinding and blending; heavy metal removal; light deburring and finishing
Cloth discs: light- to medium-pressure grinding; blending, leveling and finishing applications; for use on contours or flat surfaces
- SIZE RANGE:** 3/4" – 4" diameter
- GRIT RANGE:** 24 – 320
- ABRASIVE GRAIN:** Ceramic Alumina, Zirconia Alumina, Aluminum Oxide, Silicon Carbide
- BACKING:** Fiber or cloth
- CLOTH FLEX:** 3-ply (more aggressive), 2-ply (standard), or 1-ply (more flexible) lamination
- ATTACHMENT:** Type TS (II), Type TR (III), and Type TP (I)
- BACK-UP PADS:** Rubber with hardness variations for different applications

COATED ABRASIVE QUICK-CHANGE DISC AVAILABILITY



Fiber

- The most heavy-duty discs with resin over resin construction on heavy-duty vulcanized fiber backing
- Premium grain for applications from heavy stock removal to surface blending



NorKut

- Unique polymer backing resists cracking and breakage and can be cut down up to the 1" core
- Use the cores to grind "pinch" welds and other hard-to-reach areas



Cloth 3-Ply

- These heavy-duty, 3-ply polyester laminate construction discs are the most aggressive and durable cloth discs on the market



Cloth 2-Ply

- Our standard 2-ply laminate construction creates an aggressive and durable cloth disc for flat surfaces



Cloth 1-Ply

- The flexible, 1-ply cotton laminate construction offers added conformability on contoured surfaces or any application where added flexibility is needed

QUICK-CHANGE ATTACHMENT SYSTEMS AND CROSS REFERENCE GUIDE

Each system enables quick, safe disc changes, reducing downtime and operating expenses.

Type TS (Type II)

- Features a turn-on/turn-off style fastener
- Fastener is made of metal
- Equivalent to Standard Abrasives' SocAtt® locking system



Type TR (Type III)

- Features a roll-on/roll-off style fastener
- Fastener is made of plastic
- Equivalent to 3M™ Roloc™ fastening system

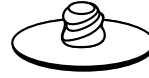

Type TP (Type I)

- Features a snap-on/snap-off style fastener
- Fastener is made of nylon



NORTON

TS

TR

TP

MERIT

Type II

Type III

Type I

3M	Roloc TS/TSM	Roloc TR	Roloc TP
Standard	TS (SocAtt)	TR (Lockit)	TP (ClickOn)
Superior	Type S	Type R	–
Arc	Type S	Type R	Type P
Pferd	Type CD	Type CDR	–
Sait	SAIT-LOK	SAIT-LOK-R	–
Camel	Turn On	Roll On	–
Klingspor	QMC	QRC	–
Garryson	Type S	Type R	–



MATERIAL/APPLICATION-TO-PRODUCT RECOMMENDATION GUIDE

	BEST Highest Productivity – Lowest Total Cost	BETTER Excellent Blend of Performance & Price	GOOD Consistent Performance – Low Initial Price
Stainless Steel / Titanium / Super Alloys	Norton Blaze R980P	Norton BlueFire R884P	Norton Neon R766
Mild Carbon Steel / Welds	Norton Blaze R980P	Norton BlueFire R884P	Norton Neon R766
Ferrous Metals / Cast Iron	Norton Blaze R980P	Norton BlueFire R884P	Norton Neon R766
Brass / Bronze / Aluminum	–	Norton BlueFire R884P	Norton Neon R766
Paint / Glue / Adhesive	–	–	Norton Neon R766
Concrete / Stone / Fiberglass	–	–	Merit Silicon Carbide

APPLICATION/GRIT RECOMMENDATION GUIDE

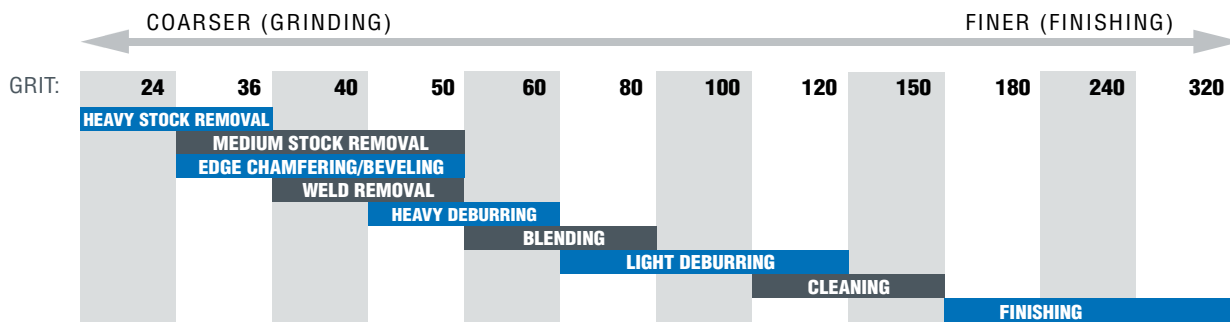

CROSS REFERENCE GUIDE

	TOTAL PERFORMANCE		INITIAL PRICE			
Abrasive	BEST		BETTER	GOOD		
Backing	Ceramic Alumina Full Ratio	Ceramic Alumina Full Ratio	Zirconia Alumina	Aluminum Oxide	Aluminum Oxide	Silicon Carbide
	Fiber	Cloth	Cloth	Cloth	Cloth	Cloth
NORTON	Blaze F980	Blaze R980P	BlueFire R884P	Neon R766	–	–
MERIT	–	–	–	–	Aluminum Oxide	Silicon Carbide
3M	983C, 988C	963G, 977F, 785C, 777F	–	–	361F	461F
Standard	–	Ceramic Pro, Ceramic	Zirconia	A/O Extra, A/O Pro	A/O	Silicon Carbide
Superior	–	Ceramic G.A.	Premium Zirc	A/O with Grinding Aid	Premium A/O, Rigid Kut A/O	–
Arc	–	–	Zirconia/ Y Standard	A/O/X Plus Coolant	A/O/Y Premium	–
Pferd	Ceramic Oxide CO	Ceramic	ZA Z	Aluminum Oxide A-Plus, Aluminum Oxide A-INOX-FORTE	Aluminum Oxide A, A/O A-FORTE	Silicon Carbide SiC
Sait	–	–	Z	3A	2A-H, 2A	–
Camel	–	–	Zirconia A0	–	Aluminum Oxide	–
Klingspor	–	Ceramic	Alumina Zirconia	–	Aluminum Oxide	–
Garryson	–	Ceramic	–	–	Aluminum Oxide	–



FEATURED PRODUCTS



EXPANDED OFFERING

NORTON BLAZE F980 CERAMIC FIBER DISCS

BEST CHOICE FOR TOUGH APPLICATIONS AND STAINLESS STEEL

FEATURES AND BENEFITS

- Norton SG ceramic grain with self-lubricating, supersize treatment provides coolest cut with significantly faster cut rates
- Heaviest fiber backing, greater durability, longest life, and edge-fray resistance



AVAILABILITY

TIER:	BEST
BRAND:	Norton
TRADENAME:	BLAZE F980
ABRASIVE:	Ceramic Alumina
BACKING:	Fiber – Heavy Duty
OTHER:	Supersized
ATTACHMENT:	TR (Type III)



SIZE (D)	GRIT	STD. PKG.	PART #
2	24	25	77696090139
	36	25	66261058704
	50	25	66261058705
	60	25	66261058706
	80	25	66261058707
3	24	25	77696090140
	36	25	66261058708
	50	25	66261058709
	60	25	66261058711
	80	25	66261058712



NORTON NORKUT ZIRCONIA DISCS

BETTER CHOICE FOR HARD-TO-GROUND AREAS WHERE FLEXIBILITY IS NOT REQUIRED

FEATURES AND BENEFITS

- Zirconia alumina grain is resin bonded to a unique polymer backing which resists cracking and breaking and can be trimmed to the 1" core
- Use the cores to grind "pinch" welds and other hard-to-reach areas
- Used with a quick change mandrel: 7/16"-20 threaded for hand-held pneumatic grinders or 1/4" mandrel for automotive drills

AVAILABILITY

TIER:	BETTER
BRAND:	Norton
TRADENAME:	NORKUT
ABRASIVE:	Zirconia Alumina
BACKING:	Extra HD Polymer
ATTACHMENT:	Threaded Hole

SIZE (D)	GRIT	STD. PKG.	PART #
3	24	20	63642503656
	36	20	63642503657
	50	20	63642503658
7/16-20 Mandrel	-	5	63642503659
1/4" Mandrel	-	5	63642503660



NORTON BLAZE R980P CERAMIC CLOTH DISCS

BEST CHOICE FOR TOUGH APPLICATIONS AND STAINLESS STEEL (3-PLY) OR CONTOURED SURFACES (1-PLY)

FEATURES AND BENEFITS

- Next-generation, Norton SG ceramic alumina grain with self-lubricating, supersize treatment provides coolest cut and significantly faster cut rates
- 3-ply heavy-duty laminate discs (Y-weight polyester yellow backing) are more aggressive; for greatest durability, longest life, and edge-fray resistance on tough applications and stainless steel
- NEW! 1-ply laminate discs (black backing) provide durability and long life, but are more conformable and flexible; ideal on contoured surfaces or any application where added flexibility is needed. Used in aircraft and aerospace manufacturing for structural hand polishing.

AVAILABILITY

TIER:	BEST			
BRAND:	Norton			
TRADENAME:	BLAZE R980P			
ABRASIVE:	Ceramic Alumina			
BACKING:	Polyester 3-Ply Heavy Duty	Polyester 1-Ply Conformable	Polyester 3-Ply Heavy Duty	Polyester 1-Ply Conformable
OTHER:	Supersized			
ATTACHMENT:	TS (Type II)	TS (Type II)	TR (Type III)	TR (Type III)

SIZE (D)	GRIT	STD. PKG.	PART #	PART #	PART #	PART #
1-1/2	36	100	66261162307	77696088201	66261162308	
	50	100	66261162309	77696088202	66261162310	
	60	100	66261162311	77696088203	66261162312	
	80	100	66261162313	77696088204	66261162314	
	120	100	66261043379	77696088206	66261043380	
2	36	25	66261162317	77696088207	66261162318	77696088219
	50	25	66261162319	77696088208	66261162320	77696088220
	60	25	66261162321	77696088209	66261162322	77696088221
	80	25	66261162323	77696088210	66261162324	77696088222
	100	25	66261043382	77696088211	66261043383	77696088223
	120	25	66261043384	77696088212	66261043386	77696088224
3	36	25	66261162327	77696088213	66261162328	77696088225
	50	25	66261162329	77696088214	66261162330	77696088226
	60	25	66261162331	77696088215	66261162332	77696088227
	80	25	66261162333	77696088216	66261162334	77696088228
	100	25	66261043389	77696088217	66261043390	77696088229
	120	25	66261043391	77696088218	66261043392	77696088230







NORTON BLUEFIRE R884P ZIRCONIA CLOTH DISCS
 BETTER CHOICE FOR SOFT METALS, WOOD, STAINLESS STEEL, AND CARBON

FEATURES AND BENEFITS

- Premium, versatile, self-sharpening zirconia alumina plus grain provides aggressive cut and up to 30% longer life than competitive zirconia alumina product
- Strong resin bond improves base adhesion and reduces grain shedding
- Advanced grain coating results in longer life and faster cut rate
- Semi-open coat retards loading on soft metals (aluminum, brass, and bronze) and wood, as well as stainless steel and carbon steel
- Durable, Y-wt, 2-ply polyester backing stands up to demanding applications: high-pressure and hard-to-grind exotic alloy

AVAILABILITY

TIER:	BETTER	BETTER
BRAND:	Norton	Norton
TRADENAME:	BLUEFIRE R884P	BLUEFIRE R884P
ABRASIVE:	Zirconia Alumina	Zirconia Alumina
BACKING:	Polyester Standard	Polyester Standard
ATTACHMENT:	TS (Type II) 	TR (Type III) 

SIZE (D)	GRIT	STD. PKG.	PART #	PART #
1	50	100	66261138609	
	60	100	66261138608	
	80	100	66261138607	
1-1/2	36	100	66261138624	66261121041
	50	100	66261138622	
	60	100	66261138621	66261121043
	80	100	66261138620	66261121044
2	24	25	66261138638	66261138672
	36	25	66261138637	66261138671
	50	25	66261138635	66261138670
	60	25	66261138634	66261121048
	80	25	66261138633	66261121049
3	24	25	66261138665	66261138675
	36	25	66261138664	66261138674
	50	25	66261138662	66261138673
	60	25	66261138661	66261121053
	80	25	66261138660	66261121054
4	36	25	66261138683	
	50	25	66261138681	
	60	25	66261137343	
	80	25	66261138679	



Merit Quick-Change Test Kit "D"

- Part # 08834165001
- Includes 150 discs, assorted grits, in 1", 2", and 3" diameters and 3" back-up pads
- Primarily aluminum oxide cloth quick-change discs
- Several zirconia alumina and FlexEdge discs are included



NORTON NEON R766 ALUMINUM OXIDE CLOTH DISCS

GOOD CHOICE FOR DIFFICULT-TO-GRIND MATERIALS THAT REQUIRE AN ECONOMICAL OPTION

FEATURES AND BENEFITS

- Premium abrasive and aluminum oxide blend for aggressive cut and longer life than competitive aluminum oxide discs
- Durable Y-weight 2-ply polyester backing and new grain coating for longer life and faster cut rate on moderately-demanding applications
- Great for difficult-to-grind materials (aluminum, brass, bronze, stainless, carbon steel, and titanium) and applications requiring an economical option
- NEW! vendible packs, ideal for vending machines, small jobs, or carrying to a job site

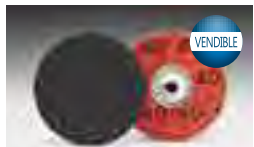

AVAILABILITY

TIER:	GOOD		
BRAND:	Norton		
TRADENAME:	NEON R766		
ABRASIVE:	Aluminum Oxide		
BACKING:	Polyester Standard		
ATTACHMENT:	TS (Type II)	TR (Type III)	TP (Type I)



SIZE (D)	GRIT	STD. PKG.	PART #	PART #	PART #
3/4	36	100			66623318933
	50	100			66623318935
	80	100			66623318937
1	36	100	66623318957		66623318950
	40	100			66623318951
	50	100	66623318959		66623318952
	60	100	66623318960		66623318953
	80	100	66623318961		66623318956
1-1/2	36	100	66623318972	66623318977	66623318967
	40	100	66623318973	66623318978	66623318968
	50	100	66623318974	66623318979	66623318969
	60	100	66623318975	66623318980	66623318970
	80	100	66623318976	66623318981	66623318971
2	24	100	66623319011	66623319013	66623319010
	36	100	66623318999	66623319005	66623318993
	40	100	66623319000	66623319006	66623318994
	50	100	66623319001	66623319007	66623318995
	60	100	66623319003	66623319008	66623318996
	80	100	66623319004	66623319009	66623318997
2	36	40 V	66623341058	66623341059	
	40	40 V	66623341060	66623341061	
	50	40 V	66623341062	66623341063	
	60	40 V	66623341064	66623341065	
	80	40 V	66623341066	66623341067	
3	24	50	66623319020	66623319026	66623319014
	36	50	66623319021	66623319027	66623319015
	40	50	66623319022	66623319028	66623319016
	50	50	66623319023	66623319029	66623319017
	60	50	66623319024	66623319030	66623319018
	80	50	66623319025	66623319031	66623319019
3	36	20 V	66623341072	66623341073	
	40	20 V	66623341074	66623341075	
	50	20 V	66623341076	66623341077	
	60	20 V	66623341078	66623341079	
	80	20 V	66623341080	66623341081	
4	36	50		66623319036	
	60	50			66623319033

V = VENDIBLE PACKAGE. 2" DISCS: 10 DISCS PER PACK / 4 PACKS PER CARTON. ORDER IN MULTIPLES OF 40.

V = VENDIBLE PACKAGE. 3" DISCS: 5 DISCS PER PACK / 4 PACKS PER CARTON. ORDER IN MULTIPLES OF 20.



MERIT ALUMINUM OXIDE CLOTH DISCS

GOOD CHOICE WHEN INITIAL PRICE IS THE PRIMARY CONSIDERATION

FEATURES AND BENEFITS

- Premium abrasive and aluminum oxide blend for aggressive cut and longer life than competitive aluminum oxide discs
- Durable Y-weight 2-ply polyester backing and new grain coating for longer life and faster cut rate on moderately-demanding applications
- Great for difficult-to-grind materials (aluminum, brass, bronze, stainless, carbon steel, and titanium) and applications requiring an economical option



TIER:	GOOD	GOOD	GOOD
BRAND:	Merit	Merit	Merit
ABRASIVE:	Aluminum Oxide	Aluminum Oxide	Aluminum Oxide
BACKING:	Polyester Standard	Polyester Standard	Polyester Standard
ATTACHMENT:	TS (Type II) 	TR (Type III) 	TP (Type I)



AVAILABILITY

SIZE (D)	GRIT	STD. PKG.	PART #	PART #	PART #
3/4	24	100	69957399601	69957399669	69957399737
	36	100	69957399602	69957399670	69957399738
	40	100	69957399603	69957399671	69957399739
	50	100	69957399604	69957399672	69957399740
	60	100	69957399605	69957399673	69957399741
	80	100	69957399606	69957399674	69957399742
	100	100	69957399607	69957399675	69957399743
	120	100	69957399608	69957399676	69957399744
	150	100	69957399609	69957399677	69957399745
	180	100	69957399610	69957399678	69957399746
1	240	100	69957399611	69957399679	69957399747
	320	100	69957399612	69957399680	69957399748
	24	100	69957399613	69957399681	69957399749
	36	100	69957399614	69957399682	69957399750
	40	100	69957399615	69957399683	69957399751
	50	100	69957399616	69957399684	69957399752
	60	100	69957399617	69957399685	69957399753
	80	100	69957399618	69957399686	69957399754
	100	100	69957399619	69957399687	69957399755
	120	100	69957399620	69957399688	69957399756
1-1/2	150	100	69957399621	69957399689	69957399757
	180	100	69957399622	69957399690	69957399758
	240	100	69957399623	69957399691	69957399759
	320	100	69957399624	69957399692	69957399760
	24	100	69957399625	69957399693	69957399761
	36	100	69957399626	69957399694	69957399762
	40	100	69957399627	69957399695	69957399763
	50	100	69957399628	69957399696	69957399764
	60	100	69957399629	69957399697	69957399765
	80	100	69957399630	69957399698	69957399766
2	100	100	69957399631	69957399699	69957399767
	120	100	69957399632	69957399700	69957399768
	150	100	69957399633	69957399701	69957399769
	180	100	69957399634	69957399702	69957399770
	240	100	69957399635	69957399703	69957399771
	320	100	69957399636	69957399704	69957399772
	24	100	69957399637	69957399705	69957399773
	36	100	69957399638	69957399706	69957399774
	40	100	69957399639	69957399707	69957399775
	50	100	69957399640	69957399708	69957399776
60	100	69957399641	69957399709	69957399777	
80	100	69957399642	69957399710	69957399778	
100	100	69957399643	69957399711	69957399779	
120	100	69957399644	69957399712	69957399780	
150	100	69957399645	69957399713	69957399781	
180	100	69957399646	69957399714	69957399782	
240	100	69957399647	69957399715	69957399783	
320	100	69957399648	69957399716	69957399784	

CONTINUED



AVAILABILITY
CONTINUED

		
GOOD	GOOD	GOOD
TIER: Merit	TIER: Merit	TIER: Merit
BRAND: Aluminum Oxide	BRAND: Aluminum Oxide	BRAND: Aluminum Oxide
ABRASIVE: Polyester Standard	ABRASIVE: Polyester Standard	ABRASIVE: Polyester Standard
BACKING: TS (Type II)	BACKING: TR (Type III)	BACKING: TP (Type I)



SIZE (D)	GRIT	STD. PKG.	PART #	PART #	PART #
3	24	50	69957399649	69957399717	69957399785
	36	50	69957399650	69957399718	69957399786
	40	50	69957399651	69957399719	69957399787
	50	50	69957399652	69957399720	69957399788
	60	50	69957399653	69957399721	69957399789
	80	50	69957399654	69957399722	69957399790
	100	50	69957399655	69957399723	69957399791
	120	50	69957399656	69957399724	69957399792
	150	50	69957399657	69957399725	69957399793
	180	50	69957399658	69957399726	69957399794
	240	50	69957399659	69957399727	69957399795
320	50	69957399660	69957399728	69957399796	
4	36	50	69957399661	69957399729	69957399797
	40	50	69957399662	69957399730	69957399798
	50	50	69957399663	69957399731	69957399799
	60	50	69957399664	69957399732	69957399800
	80	50	69957399665	69957399733	69957399801
	100	50	69957399666	69957399734	69957399802
	120	50	69957399667	69957399735	69957399803
	180	50	69957399668	69957399736	69957399804





MERIT SILICON CARBIDE CLOTH DISCS
GOOD CHOICE FOR NON-FERROUS MATERIALS

FEATURES AND BENEFITS

- Sharp, silicon carbide abrasive
- X-weight 2-ply backing
- High initial cut and penetration for nonferrous materials

AVAILABILITY

		
GOOD	GOOD	GOOD
TIER: Merit	TIER: Merit	TIER: Merit
BRAND: Silicon Carbide	BRAND: Silicon Carbide	BRAND: Silicon Carbide
ABRASIVE: Cotton Standard	ABRASIVE: Cotton Standard	ABRASIVE: Cotton Standard
BACKING: TS (Type II)	BACKING: TR (Type III)	BACKING: TP (Type I)



SIZE (D)	GRIT	STD. PKG.	PART #	PART #	PART #
2	40	100	08834165252	08834164275	08834162166
	60	100	08834165254	08834164163	08834162168
	80	100	08834165255	08834166155	08834162169
	120	100	08834165257	08834164837	08834162171
	180	100	08834165259	08834167313	08834162173
3	40	50	08834165267	08834164277	
	60	50	08834165269	08834164850	
	80	50	08834165270	08834166159	08834162188
	120	50	08834165272	08834166160	08834162190
	180	50	08834165274	08834168177	08834164971



Quick-Change Back-up Pads

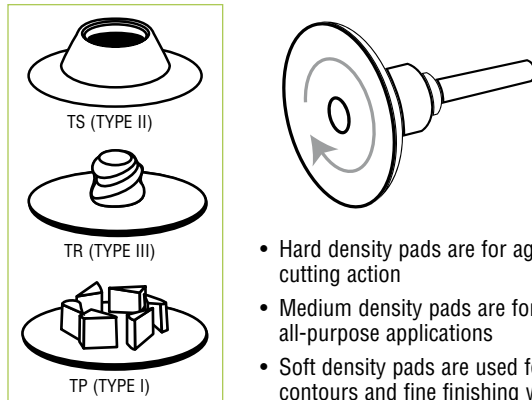

- Hard density pads are for aggressive cutting action
- Medium density pads are for all-purpose applications
- Soft density pads are used for contours and fine finishing work

DIAMETER/RPM	DENSITY	TS (TYPE II)	TR (TYPE III)	TP (TYPE I)
Quick-Change Back-up Pads				
9/16"		66261054014		66261054013
40,000 RPM				
3/4"	Medium	08834164206	08834164038	08834164001
40,000 RPM				
1"	Medium	08834164651	08834164037	08834164002
40,000 RPM				
1-1/2"	Hard	08834164622	08834164640	08834163996
30,000 RPM	Medium	08834164146	08834161174	08834164003
2"	Hard	08834164624	08834164643	08834163997
30,000 RPM	Medium	08834164198	08834164922	08834164004
	Soft	08834161625	08834164641	08834163949
3"	Hard	08834161626	08834164036	08834163998
20,000 RPM	Medium	08834164113	08834164949	08834164005
	Soft	08834164626	08834164644	08834163948
4"	Medium	08834164135	08834164655	08834164006
15,000 RPM				
Vendible Quick-Change Back-up Pads				
2" Vendible	Medium	66623341082	66623341083	
30,000 RPM				
3" Vendible	Medium	66623341084	66623341085	
20,000 RPM				



ALL QUICK-CHANGE BACK-UP PADS HAVE A 1/4" SOLID STEEL SHANK. STD. PKG. = 1 VENDORABLE 2" 10 DISCS/PACK; 3" 5 DISCS/PACK; 2" AND 3" 4 PACKS PER CARTON TO ORDER NORTON QUICK-CHANGE BACK-UP PADS, SEE PAGE 183 (NON-WOVEN DISC SECTION)

Replacement Medium Density Rubber Pads for Quick-Change Back-up Pads

DIAMETER	MODEL #	TP (TYPE I)
Quick-Change Replacement Rubber Back-up Pads		
3/4"	RR75	08834164008
1"	RR10	08834164009
2"	RR20	08834164011
3"	RR30	08834164012
4"	RR40	08834164013

WHEN THE RUBBER PAD HAS WORN AWAY, BUT THE STEEL COMPONENTS OF YOUR QUICK-CHANGE BACK-UP ARE STILL SERVICEABLE, ORDER THESE REPLACEMENT RUBBER PADS. STD. PKG. = 1

Replacement Assemblies and Shanks for Quick-Change Back-up Pad

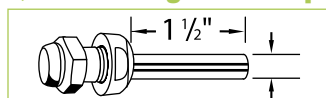

DESCRIPTION	STD. PKG.	PART #
Replacement Mandrels and Nut Assembly		
TP (Type I) Assembly RMN1 for 3/4 - 2	1	08834164015
TP (Type I) Assembly RMN3 for 3 - 4	1	08834164016
TS (Type II) & TR (Type III) Replacement 1/4" Shank	1	08834164303

ASSEMBLIES REPLACE ALL THE STEEL COMPONENTS OF A QUICK-CHANGE BACK-UP PAD. THIS SHANK REPLACES THE SCREW-IN 1/4" SOLID STEEL SHANK ONLY.

Extension Mandrels and Assembly

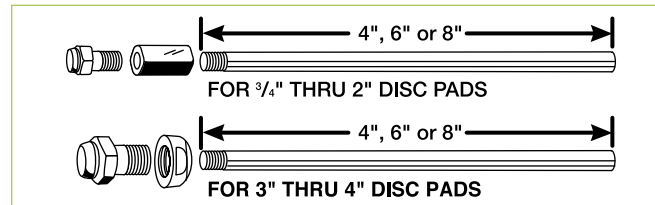

DIAMETER	MODEL #	LENGTH	STD. PKG.	PART #
Extension Mandrels and Assembly – TP (Type I)				
3/4 - 2"	EMN-14	4"	1	08834164017
3/4 - 2"	EMN-16	6"	1	08834164018
3/4 - 2"	EMN-18	8"	1	08834164019
3 - 4"	EMN-34	4"	1	08834164020
3 - 4"	EMN-36	6"	1	08834164026
3 - 4"	EMN-38	8"	1	08834164021

MNA-1 Pad Adapters

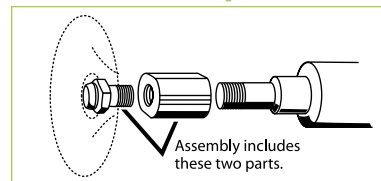

DISC DIAMETER	MODEL NO.	STD. PKG.	PART #
MNA-1 Pad Adapters – TP (Type I)			
3/4 - 2"	MNA 1/4-20 THD.	1	08834161176
3/4 - 2"	MNA 3/8-24	1	08834164055
3/4 - 2"	MNA 5/8-11	1	08834163001
3 - 4"	MNA 1/4-20	1	08834163002
3 - 4"	MNA 3/8-24	1	08834164041
3 - 4"	MNA 5/8-11	1	08834164028

CONVERT A TP (TYPE I) BACK-UP PAD 1/4" DIAMETER SOLID SHANK TO A THREADED SHANK

MNA-23 Pad Adapters

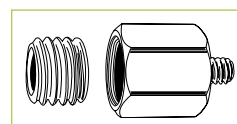

DISC DIAMETER	MODEL #	STD. PKG.	PART #
MNA-23 Pad Adapters – TS (Type II) and TR (type III)			
3/4 - 4"	MNA-23 3/8-24 5/8"-11 THD.	1	08834162764

FOR USE ON A RIGHT ANGLE GRINDER: CONVERT TS (TYPE II) AND TR (TYPE III) BACK-UP PAD 1/4" DIAMETER SOLID SHANKS TO THREADED SHANKS. THE LARGER 5/8-11 ADAPTER (FOR 4-1/2" DISCS) IS USED ALONE TO CONVERT TO A 5/8-11 THREAD. THE 3/8-24 INSERT (FOR 4" DISCS) IS SCREWED INTO THE 5/8-11 ADAPTER TO CREATE A 3/8-24 THREAD ADAPTER.

1/4" Diameter Extension Mandrel

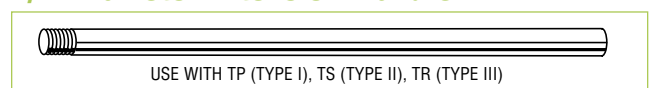

MODEL NO.	LENGTH	STD. PKG.	PART #
1/4" Diameter Extension Mandrel 1/4-20 Thread			
EM-144	4"	1	08834154185
EM-146	6"	1	08834154186
EM-148	8"	1	08834154187



CATEGORY DEFINITION

Paper sheets and rolls are engineered for optimum performance when sanding metal, wood, composites and painted surfaces. The sheets are packed in protective packaging to eliminate waste and permit easy, neat storage.

- CATEGORIES:** All purpose, wood sanding, stearated (non-loading), waterproof, and heavyweight
- APPLICATIONS:** Light-duty metal sanding, primer sanding, defect removal from painted surfaces, filler sanding, sanding and finishing of composites and fiberglass, bare wood sanding, sanding between sealer coats
- SIZE RANGE:** Full Sheets, Cut Sheets, File Strips and Rolls
- GRIT RANGE:** 36 – 2500
- ABRASIVE GRAIN:** Ceramic Alumina, Zirconia Alumina, Aluminum Oxide, Silicon Carbide, and Garnet
- PAPER WEIGHTS:** Heavy-weight – E; Light-weight – A and D

MATERIAL-TO-PRODUCT RECOMMENDATION GUIDE

	BEST Highest Productivity – Lowest Total Cost	BETTER Excellent Blend of Performance & Price	GOOD Consistent Performance – Low Initial Price
Unfinished Metal	A275	–	PB273
Primed / Painted Surfaces / Between Coats	A275	A475	PB273
Fiberglass / Composites	A275	A475	PB273
Bare Wood	A275	–	A511, A513, A514
Clear Coat Sanding	T214, T401	–	T461
Sealer Sanding	A275	A475	PB273
Lacquer Sanding	T214, T401	T414	T461
Wet Sanding	T214, T401	T414	T461
Paint Stripping	A275, A259 (3X)	A475	A290
All Purpose Dry Sanding	A275, A259 (3X)	–	A212, A213, A211

APPLICATION/GRIT RECOMMENDATION GUIDE

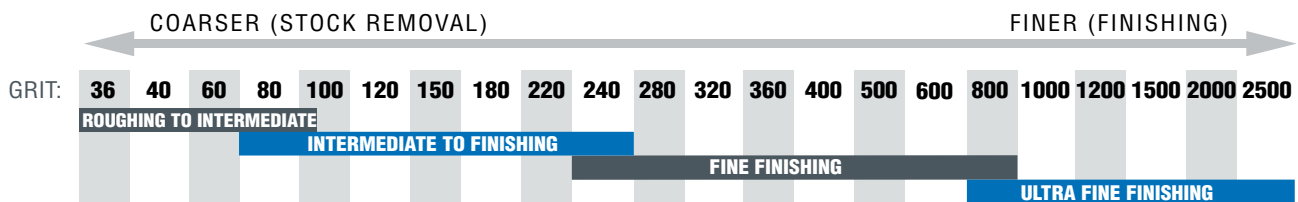

RECOMMENDED BACKING WEIGHT

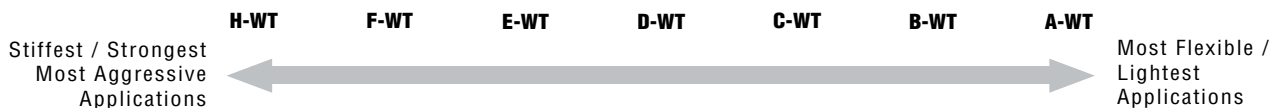

CROSS REFERENCE GUIDE

NORTON	3M	Hermes	Klingspor	Mirka	SIA	VSM
Steartated (Non-Loading)						
A975	734U, 735U, 765L, 334U	-	-	-	1950 siaspeed	-
A275 / A259 (3X)	216U, 334U	HC133	PS33	Royal, Royal Micro	1950 siaspeed	-
A475	405N, 414N, 415N/U	PSF-LL, SA168	PL35	Carat Flex, FineFlex	1701 sialac 1748 siarexx fine	CP131A
A290	236U	HCAB-LL	PS33, PL36	Bulldog Gold	1960 siarexx cut	KP911
PB273	Red, NX	-	PL36	GoldFlex	-	-
Waterproof						
T214	213Q	WAFlex28B	PS12	-	1913 siawat	-
T401	401Q	WSFlex16	PS11, PS14	Waterproof (A)	-	CP918A
T414	413Q	WSFlex16	PS11, PS14	Waterproof (A)	-	CP918A
T461	438Q, 431Q	WSFlex18C	PS11, PS14	-	1727 siawat	CP918C
All Purpose/Wood						
A211	230U, 240N, 346U	-	-	-	-	KP31C
A212	210N	HFB	PL31	-	-	-
A213	230N	HFB	PL31	-	-	KP31B
A511	110N	-	-	-	1400 sianor	-
A513	130N	GCAB	-	-	-	-
A514	140N	GCAB	-	-	-	-
Heavyweight Paper						
H875P	750U, 751U, 740I, 745I	-	-	Royal Coarse Cut	-	KP510E, KP709

Aluminum Oxide All-Purpose Sanding and Garnet Wood Sanding 9" x 11" Paper Sheets

AVAILABILITY
9 X 11
PAPER SHEETS

SIZE (W x L)	GRIT	MIN./STD. PKG.	PART #	PART #	PART #	PART #	PART #	PART #	PART #
9 x 11	36	25/125	66261100335						
	40	25/125	66261100330						
	50	50/250	66261100325						
	60	50/250		66261100320			66261101560		
	80	50/250		66261100315			66261101555	66261101505	07660701584*
	100	100/500		66261100295			66261101535	66261101500	07660701583*
	120	100/500		66261100290			66261101530	66261101495	07660701582*
	150	100/500		66261100285			66261101525	66261101490	07660701581*
	180	100/500			66261100245		07660700355*	66261101489	07660701580*
	220	100/500			07660700156		07660700354*	66261101488	07660701579*
	240	100/500							
	280	100/500							
	Asst•	100/500					07660700365*		

* PACKAGING STANDARDS: JOB PACKS: 25 SHEETS PER PACK / 10 PACKS PER STANDARD PACKAGE FOR A TOTAL OF 250 SHEETS
• ASSORTED CONTAINS 6 EACH OF 60, 100, 150 GRIT AND 7 EACH OF 220 GRIT



Stearated (Non-Loading) Aluminum Oxide and Silicon Carbide 9" x 11" Sheets

FEATURED PRODUCTS



NO-FIL NORTON ADALOX A275

THE BEST CHOICE FOR SANDING PAINTED SURFACES, COMPOSITES, PLASTICS OR ANY MATERIAL THAT TENDS TO LOAD

FEATURES

- Premium P-graded, heat-treated aluminum oxide abrasive
- Unique fiber-reinforced, B-weight latex-saturated backing
- Water-based stearate, non-pigmented, No-Fil coating
- Full resin adhesive bond

BENEFITS

- Superior life, fast cut rate, consistent finish
- 50-60% improvement in tear strength
- Exceptional flexibility, can be folded without cracking
- Provides maximum load resistance and extended life: no color transfer to work
- Provides exceptional resistance to abrasive grain shedding especially when folding to sand into corners; long life



NO-FIL NORTON DURITE A475

THE BETTER CHOICE FOR GEL COATS, HARD COMPOSITE SUBSTRATES, ABRASION-RESISTANT COATINGS, AND WOODWORKING APPLICATIONS

FEATURES

- P-graded, silicon carbide abrasive
- Water-based stearate, non-pigmented, No-Fil coating
- Fiber-reinforced, latex paper backing

BENEFITS

- Easy penetration of the hardest surfaces
- Resists loading for longest usable product life, no color transfer to work
- Provides flexibility and resistance to tearing

AVAILABILITY 9 X 11 PAPER SHEETS



TIER:	BEST	BEST	BETTER	GOOD
BRAND:	Norton	Norton	Norton	Merit
CAP CODE:	A275 NO-FIL	A259 (3X) NO-FIL	A475 NO-FIL	PB273 NO-FIL
ABRASIVE:	Aluminum Oxide	Aluminum Oxide	Silicon Carbide	Aluminum Oxide
BACKING WEIGHT:	B-Weight	B-Weight	B-Weight	B-Weight
OTHER:	P-Graded	P-Graded	P-Graded	P-Graded

SIZE (W x L)	GRIT	MIN./STD. PKG.	PART #	PART #	PART #	PART #
9 x 11	60	50/250		07660702642*		
	80	50/250	66261131634	07660702641*	66254487393	66623311878
	100	100/500	66261131633	07660702640*	66254487394	66623311877
	120	100/500	66261131632	07660702639*	66254487395	66623311876
	150	100/500	66261131631	07660702638*	66254487396	66623311875
	180	100/500	66261131630	07660702637*	66254487397	66623311874
	220	100/500	66261131629	07660702636*	66254487398	66623311873
	240	100/500	66261131628		66254487399	66623311879
	280	100/500	66261131627			
	320	100/500	66261131626	07660702633*	66254487400	66623311871
	400	100/500	66261131624	07660702632*		66623311870
	500	100/500	66261131623			
	600	100/500	66261131622			
	800	100/500	66261131621			
	1000	100/500	66261131620			
	1200	100/500	66261131619			
1500	100/500	66261131618				

* PACKAGING STANDARDS: A259 (3X) JOB PACKS: 20 SHEETS PER PACK / 10 PACKS PER STANDARD PACKAGE FOR A TOTAL OF 200 SHEETS



Waterproof Aluminum Oxide and Silicon Carbide 9" x 11" Sheets

FEATURED PRODUCTS



NORTON BLACK ICE T214 AND T401 WATERPROOF BEST CHOICE FOR ALL WET APPLICATIONS

FEATURES

BENEFITS

- | | |
|---|---|
| ■ T214: Premium, P-graded, heat-treated aluminum oxide abrasive | ■ Ultimate cut and life in wet applications |
| ■ T401: Premium, ultra fine (1000 – 2500 JIS graded) silicon carbide abrasive | ■ Ultimate finish in wet applications |
| ■ Improved resin bond system | ■ Long life in wet applications |
| ■ High-strength B-weight high-latex, waterproof paper backing | ■ Ultimate flexibility, with wet-curl resistance |
| | ■ Environmentally stable, resists humidity-caused curling |

AVAILABILITY
9 X 11
PAPER SHEETS

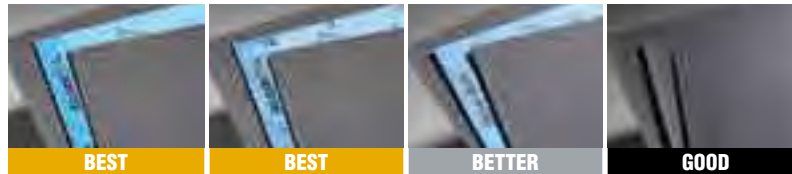

TIER:	BEST	BEST	BETTER	GOOD
BRAND:	Norton	Norton	Norton	Norton
CAP CODE:	T214	T401	T414	T461
ABRASIVE:	Aluminum Oxide	Silicon Carbide	Silicon Carbide	Silicon Carbide
BACKING WEIGHT:	B-Weight	B-Weight	B-Weight	C-Weight
OTHER:	P-Graded	JIS Graded	CAMI Graded	CAMI Graded

SIZE (W x L)	GRIT	MIN./STD. PKG.	PART #	PART #	PART #	PART #
9 x 11	60	50/250				66261101175
	80	50/250				66261101170
	100	50/250				66261101165
	120	50/250				66261101160
	150	50/250				66261101155
	180	50/250				66261101150
	220	50/250	66261139389		66261139367	
	240	50/250	66261139388		66261139366	66261130331
	280	50/250			66261139365	
	320	50/250	66261139386		66261139364	66261130332
	360	50/250			66261139363	
	400	50/250	66261139385		66261139362	66261130333
	500	50/250	66261139384		66261139361	
	600	50/250	66261139383		66261139360	66261130334
	800	50/250	66261139382			
	1000	50/250		66261139381		
	1200	50/250		66261139380		
	1500	50/250		66261139379		
	2000	50/250		66261139378		
	2500	50/250		66261139377		

Waterproof Sanding Blocks – with “grabbing” power

Dual Density Wet Sanding Block

- No adhesive required: simply wrap a 5-1/2" x 9" (9" x 11" cut in half) sheet around the block
- The dense side is for more aggressive blocking, while the soft side is for color sanding
- Equalizes sanding pressure for fine grit applications

Holey Block

- No adhesive required: simply wrap a 5-1/2" x 9" (9" x 11" cut in half) sheet around the block
- A rugged, semi-rigid, multi-purpose sanding block engineered for flat to medium curved surfaces
- A tactical hole pattern side provides numerous cutting edges to create a 30% faster cut rate
- The plain side provides firmness and a comfortable, easy-to-hold surface

DESCRIPTION	STD. PKG.	PART #
Wet Sanding Block	12	63642503728
Holey Block	8	63642503729

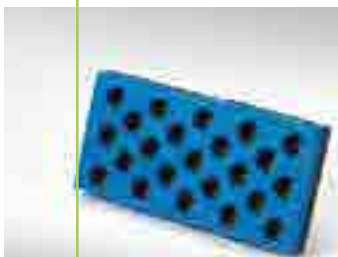



File Strips / Hand Sanding Cut Sheets / Rolls

FEATURED PRODUCTS



NORTON BLUEFIRE H875P

EXCELLENT FOR SOFT MATERIAL APPLICATIONS

FEATURES

- Patented zirconia abrasive
- Strong E-weight paper, latex impregnated
- Open coat design

BENEFITS

- Extended life over original NorZon products
- Increased durability and chip resistance, flexible
- Reduced loading; ideal for body filler, fiberglass, composite sanding

AVAILABILITY PAPER FILE STRIPS

TIER:	BEST	BEST	BEST	BEST	BETTER	BETTER	BETTER
BRAND:	Norton	Norton	Norton	Norton	Norton	Norton	Norton
CAP CODE:	A275 NO-FIL	A275 NO-FIL	A275 NO-FIL	A275 NO-FIL	H875P	H875P	H875P
ABRASIVE:	A/O	A/O	A/O	A/O	Z/A	Z/A	Z/A
BACKING WEIGHT:	B-Weight	B-Weight	B-Weight	B-Weight	E-Weight	E-Weight	E-Weight
BACKING ATTACHMENT:	Non-PSA	PSA	Hook/Loop	Hook/Loop Vac	Non-PSA	PSA	Hook/Loop
OTHER:	P-Graded	P-Graded	P-Graded	P-Graded			

SIZE (W x L)	GRIT	MIN/STD. PKG.	PART #	PART #	PART #	PART #	MIN/STD PKG	PART #	PART #	MIN/STD PKG	PART #
2-3/4 x 16	100	50/500				66261131657					
	120	50/500				66261131656					
	180	50/500				66261131654					
2-3/4 x 16-1/2	36						50/250		66261123610	25/125	66261123616
	40						50/250		66261123609	25/125	66261123615
	80	50/500		66261131640	66261131646		50/250		66261123608	25/125	66261123614
	100	50/500		66261131639	66261131645						
	120	50/500			66261131644						
	150	50/500		66261131637	66261131643						
	180	50/500		66261131636	66261131642						
2-3/4 x 17-1/2	36						50/250	66261123622			
	40						50/250	66261123621			
	80	50/500	66261131652				50/250	66261123620			
	100	50/500	66261131651				50/250	66261126512			
	120	50/500	66261131650								
	150	50/500	66261131649								
	180	50/500	66261131648				50/250	66261126511			
220	50/500	66261131647									



VACUUM HOLE PATTERN FOR 2-3/4 X 16 FILE STRIPS

Sanding Boards

PSA/Non-PSA Sanding Board

- This sanding board has a cushioned surface
- Spring clips mounted at each end securely hold 2-3/4" x 16-1/2" PSA file strips and 2-3/4" x 17-1/2" non-PSA file strips

Hook and Loop and Non-PSA Sanding Board

- Lightweight, rugged design for easy sanding of plastic fillers
- Spring clips mounted at each end securely hold 2-3/4" x 16-1/2" hook and loop file strips and 2-3/4" x 17-1/2" non-PSA file strips
- Air file shoe eliminates the need for clips. The quick-change backing positively locks and unlocks for fast use.

DESCRIPTION	STD. PKG.	PART #
Hook and Loop/Non-PSA File Strip Sanding Board	5	63642552836
Hook and Loop Air File Shoe	5	63642552835
PSA/Non-PSA File Strip Sanding Board	6	63642542724





**AVAILABILITY
PAPER CUT SHEETS**



TIER:	GOOD	GOOD
BRAND:	Norton	Norton
CAP CODE:	A290 NO-FIL	A213
ABRASIVE:	Aluminum Oxide	Aluminum Oxide
BACKING WEIGHT:	C-Weight	C-Weight
OTHER:	P-Graded	P-Graded

SIZE (W x L)	GRIT	MIN./STD. PKG.	PART #	PART #
3-2/3 x 9	60	100/1000		66261102925
	80	100/1000	66261101119	66261102920
	100	100/1000		66261102900
	120	100/1000		66261102895
	180	100/1000	66261101124	
	220	100/1000	66261101123	



Rubber Hand Sanding Blocks

- Resilient rubber blocks that conform well to mild contours and flat surfaces

DESCRIPTION	STD. PKG.	PART #
2-3/4 x 5	5	07660701889

**AVAILABILITY
PSA AND
HOOK AND LOOP
PAPER ROLLS**



TIER:	BEST	BEST	BEST	BETTER	BETTER	BETTER	BETTER	BEST	GOOD
BRAND:	Norton	Norton	Norton	Norton	Norton	Norton	Norton	Norton	Merit
CAP CODE:	A975 NO-FIL	A975 NO-FIL	A975 NO-FIL	A275 NO-FIL	A275 NO-FIL	A275 NO-FIL	A275 NO-FIL	A975 NO-FIL	PB273 NO-LOAD
ABRASIVE:	Ceramic Alumina	Ceramic Alumina	Ceramic Alumina	Aluminum Oxide	Aluminum Oxide	Aluminum Oxide	Aluminum Oxide	Ceramic Alumina	Aluminum Oxide
BACKING WEIGHT:	C-Wt.	C-Wt.	B-Wt.	B-Wt.	B-Wt.	B-Wt.	B-Wt.	B-Wt.	B-Wt.
BACKING ATTACHMENT:	PSA	PSA	PSA	PSA	PSA	PSA	PSA	Hook & Loop*	Hook & Loop•
OTHER:	P-Graded	P-Graded	P-Graded	P-Graded	P-Graded	P-Graded	P-Graded	P-Graded	P-Graded
SIZE:	2-3/4" x 25yd	2-3/4" x 30yd	2-3/4" x 45yd	2-3/4" x 25yd	2-3/4" x 30yd	2-3/4" x 45yd	4-1/2" x 10 yd	2-3/4" x 13 yd	3" x 12 yd

GRIT	MIN./STD. PKG.	PART #	PART #	PART #	PART #	PART #	PART #	PART #	MIN/STD PKG	PART #	PART #
80	1/5	66261149566			66261131691			66261131697	1/4	63642506261	66623345609
100	1/5					66261131690		66261131696			
120	1/5		66261149564			66261131689		66261131695	1/4	63642506259	66623334493
150	1/5			66261149563			66261131688	66261131694	1/4	63642506258	66623334494
180	1/5			66261149562			66261131687	66261131693	1/4	63642506257	66623334495
220	1/5			66261149561			66261131686	66261131692	1/4	63642506256	66623345611
240	1/5						66261131685				
320	1/5			66261149558			66261131683		1/4	63642506255	66623335601
400	1/5			66261149557			66261131681		1/4	66623329518	66623345612
500									1/4	66623329547	
600	1/5						66261131679		1/4	66623329548	

* THE 2-3/4" WIDE HOOK AND LOOP PAPER ROLL IS PERFORATED AT 2-3/4" WHICH ALLOWS USE ON ALL STANDARD LENGTHS OF HAND BLOCKS AND FILE BOARDS.

• THE 3" WIDE HOOK AND LOOP PAPER ROLL IS PERFORATED AT 4-1/4" TO ALLOW FOR USE ON DYNABRADE® "DYNABUG II®" TOOL.

Roll Accessories



PSA Roll Dispenser

- Heavy-duty wire dispenser has a vinyl coating to protect the work surface
- Accommodates two 2-3/4" PSA rolls; stackable for multi-grit operations. Attach to wall or mount on cabinet



PSA/Hook & Loop Sanding Blocks

- Ergonomically-shaped flexible foam blocks used with 2-3/4" rolls, fit comfortably in your hand
- Firm block produces a truly flat surface
- The soft block is designed for flat surfaces and contours

DESCRIPTION	STD. PKG.	PART #
PSA Roll Dispenser	1	63642542773

SIZE	BACKING ATTACHMENT:		PSA		HOOK & LOOP	
	DESCRIPTION	STD. PKG.	PART #	PART #		
2-3/4 x 5	Soft	5	63642542090	63642542092		
2-3/4 x 5	Firm	5	63642542091	63642542093		
2-3/4 x 7-3/4	Soft	5		63642542095		
2-3/4 x 7-3/4	Firm	5	63642542094			



Rotolo Foam Sanding Pads

APPLICATION/GRIT RECOMMENDATION GUIDE

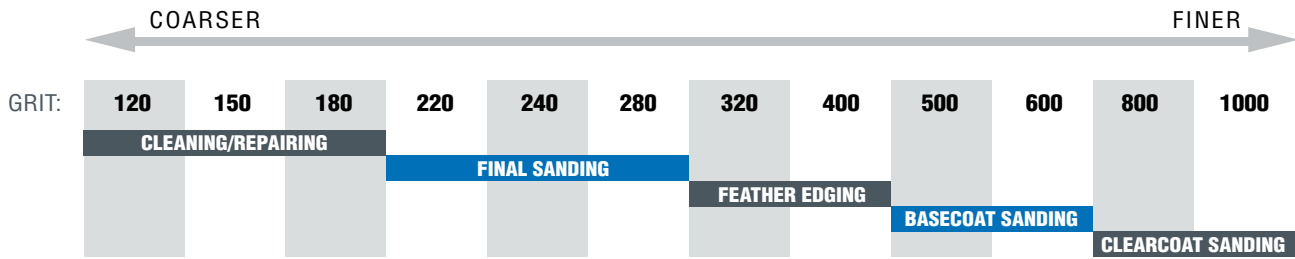

FEATURED PRODUCTS



NO-FIL NORTON ADALOX A275 ROTOLO FOAM ROLLS

THE BETTER CHOICE FOR FINE SANDING FLAT AND CURVED SURFACES

FEATURES

- A275 (premium P-graded, aluminum oxide grain with No-Fil coating) on Rotolo foam backing
- 4-1/2" wide x 82' long roll perforated every 5-1/2"
- Convenient dispensing box

BENEFITS

- Perfect for hand sanding without leaving finger marks
- Provides outstanding finish on wood, metal, composites, primers, sealers, and top coats
- Fast cut and long life without loading
- Compatible with all coatings
- 50% – 60% improvement in tear strength
- Standard 1/4 sheet size for hand or machine sanding
- 178 sheets per roll
- Protects A275 Rotolo foam from damage

AVAILABILITY

TIER:	BETTER
BRAND:	Norton
TRADENAME:	ROTOLO
ABRASIVE:	Aluminum Oxide

SIZE (W x L)	GRIT SIZE	ROLLS/STD. PKG.	PART #
4-1/2" x 82'	P120	2	63642535316
	P150	2	63642557584
	P180	2	63642557599
	P220	2	63642557600
	P240	2	63642557602
	P280	2	63642557604
	P320	2	63642557606
	P400	2	63642557608
	P500	2	63642557611
	P600	2	63642557612
	P800	2	63642557613
	P1000	2	63642557616





CATEGORY DEFINITION

Engineered for flexibility and fast cutting, cloth sheets and rolls have a longer life than paper. They tear cleanly and straight without shedding and are packed in a protective dispenser to eliminate waste and damage.

- CATEGORIES:** All purpose, fine finishing, and screen-back
- APPLICATIONS:** Scouring and light deburring, scale and rust removal, blending and fine sanding, polishing lathe turnings, rolls and cylinders, and blending machine tool marks
- SIZE RANGE:** Sheets: 9" x 11"
Rolls: 1" x 10 yds., 1-1/2" – 2" x 25 yds., 1" – 4" x 50 yds.
- GRIT RANGE:** 40 – 600, extra coarse, coarse, medium, fine
- ABRASIVE GRAIN:** Aluminum Oxide, Silicon Carbide, Emery

CROSS REFERENCE GUIDE

NORTON	GOOD			
	Metalite K224/K225	Metalite K227	Emery K622	Screen-Bak Q421
3M	311T Three-M-lte BG 211K Electrocut	211K Three-M-lte 311K Three-M-lte	011k Crystal Bay	481Q
Hermes	RB317LX	RB232J	–	–
Klingspor	CS310X	KL361	KL371	–
Sait	DA-F	EA-F	–	Saitscreen
SIA	–	2947J	C680J	–
VSM	KK504X	KK504J, KK504X	–	–

APPLICATION/STARTING RECOMMENDATION GUIDE

Durability/Stock Removal Fast Cut	Conformability Excellent Finish	Slower Cut Fine Finish	Waterproof Load Resistant
Metalite K224/K225	Metalite K227	Emery K622	Screen-Bak Durite Q421

**AVAILABILITY
CLOTH SHEETS**

SIZE (W x L)	GRIT	MIN./STD. PKG.	GOOD			MIN./STD. PKG.	PART #
			METALITE K224/K225	METALITE K227	EMERY K622		
9 x 11	40	25/125	66261058713				
	50	25/125	66261101862				
	60	25/125	66261101861				
	80	25/125	66261126340	66261101750		25/125	66261100960
	100	50/250	66261126339	66261101745		25/125	66261100955
	120	50/250	66261126338	66261101740		25/125	66261100950
	150	50/250	66261126337	66261101735		25/125	66261100945
	180	50/250	66261126336	66261101730		25/125	66261100940
	220	50/250	66261126335			25/125	66261100935
	240	50/250	66261126334				
	280	50/250	66261126333	66261101720			
	320	50/250	66261126332	66261101710		25/125	66261100920
	400	50/250	66261126331	66261101705		25/125	66261100915
	500	50/250		66261101700			
	600	50/250	66261126330				
	Extra Coarse	25/125			66261101255		
	Coarse	25/125			07660701307		
	Medium	50/250			07660701309		
	Fine	50/250			07660701308		



AVAILABILITY CLOTH ROLLS



TIER:	GOOD	GOOD	GOOD	GOOD	GOOD
BRAND:	Norton	Norton	Norton	Norton	Norton
TRADENAME:	METALITE K224/K225	METALITE K224/K225	METALITE K224/K225	METALITE K224/K225	METALITE K224/K225
ABRASIVE:	Aluminum Oxide	Aluminum Oxide	Aluminum Oxide	Aluminum Oxide	Aluminum Oxide
SIZE:	1" x 10 yds	1" x 50 yds	1-1/2" x 50 yds	2" x 50 yds	4" x 50 yds
OTHER:	P-Graded	P-Graded	P-Graded	P-Graded	P-Graded

GRIT	MIN./STD. PKG.	PART #	PART #	PART #	PART #	PART #
40	1/5		66261058716	66261058715	66261058714	
50	1/5		66261127728	66261127730	66261127732	
60	1/5		66261127729	66261127731	66261127733	
80	1/5	66261134298	66261126276	66261126288	66261126299	
100	1/5	66261134299	66261126275	66261126287	66261126298	
120	1/5	66261134300	66261126274	66261126286	66261126297	66261127285*
150	1/5	66261134301	66261126273	66261126285	66261126296	
180	1/5	66261134302	66261126272	66261126284	66261126295	
220	1/5		66261126271	66261126283	66261126294	
240	1/5	66261134303	66261126270	66261126282	66261126293	
280	1/5		66261126269	66261126281	66261126292	
320	1/5	66261134304	66261126268	66261126280	66261126291	
400	1/5		66261126267	66261126279	66261126290	
600	1/5		66261126266	66261126278	66261126289	

* PACKAGING STANDARDS: 4" ROLL MIN. /STD. PKG.: 6

AVAILABILITY CLOTH ROLLS



TIER:	GOOD	GOOD	GOOD	GOOD	GOOD
BRAND:	Norton	Norton	Norton	Norton	Norton
TRADENAME:	METALITE K227	METALITE K227	METALITE K227	SCREEN-BAK Q421	SCREEN-BAK Q421
ABRASIVE:	Aluminum Oxide	Aluminum Oxide	Aluminum Oxide	Silicon Carbide	Silicon Carbide
SIZE:	1" x 50 yds	1-1/2" x 50 yds	2" x 50 yds	1-1/2" x 25 yds	2" x 25 yds
OTHER:	P-Graded	P-Graded	P-Graded	P-Graded Waterproof	P-Graded Waterproof

GRIT	MIN./STD. PKG.	PART #	PART #	PART #	PART #	PART #
80	1/5	66261109180	66261109255	66261109335	66261107275*	
100	1/5	66261058721	66261058719	66261109330		
120	1/5	66261109170	66261109245	66261109325	66261107270*	66261149811*
150	1/5	66261058720	66261058717	66261109320		
180	1/5	66261109160	66261109235	66261109315	66261107265*	
280	1/5	66261109150	66261109225	66261109305		
320	1/5	66261109140	66261109215	66261109295		

* PACKAGING STANDARDS: MIN. /STD. PKG.: (Q421) 1/10

FastTrack Service – Cloth Rolls

FastTrack delivery is available on made-to-order aluminum oxide R228 and K225 50-yard rolls with 5-day lead-time. Contact your local distributor for details and prices.

Availability

- Width: 2" – 12"
- Length: 50 yards

FastTrack Roll Quantity Availability

WIDTH	MINIMUM QTY.	MAXIMUM QTY.
2" to 9"	5 Rolls	10 Rolls
> 9" to 11"	4 Rolls	8 Rolls
>11" to 12"	3 Rolls	6 Rolls

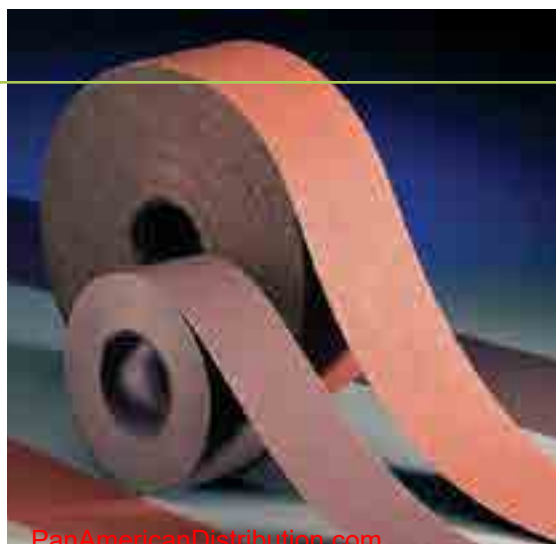



CATEGORY DEFINITION

Flexible, abrasive sanding sponges for a wide variety of curved, contoured or flat surface applications on wood, metal, paint, plastic, ceramics and drywall.

APPLICATIONS: Light stock removal, sanding sealer and wash-coats, touch-up or repair of primer, sanding contours and intricate shapes, and finishing

BENEFITS: Can be used wet or dry
 Clog resistant, washable, reusable
 Easy to use, can be folded without cracking
 Conformable
 Generate a consistent surface finish

WHY CHOOSE ABRASIVE SPONGES VERSUS CONVENTIONAL SHEETS?



Eliminate Clogging

- The combination of flexible foam backing material and abrasive grit adhesion continually releases sanded material
- Any clogging can be washed out

Pressure Control

- Foam backing allows optimum pressure distribution to prevent sanding through surfaces
- Pressure spots are eliminated providing even surface pattern

Adapt to Contours

- Flexible foam allows adaptability to contours, shapes or areas of limited access
- No folding or buckling results in an even pattern without scratching

SURFACE FINISHING CHART – CONTOUR SPONGES VERSUS SHEETS

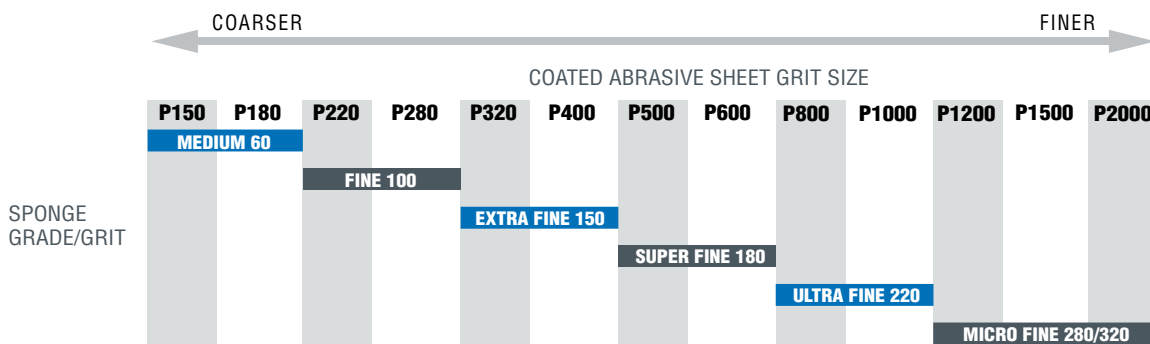

SURFACE FINISHING CHART – SPONGE PADS VERSUS SHEETS

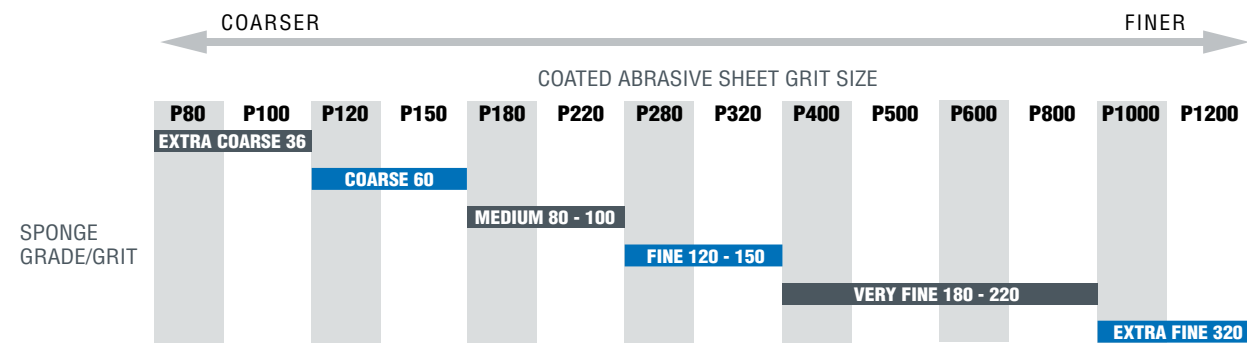

CROSS REFERENCE GUIDE

	BETTER	GOOD	GOOD	GOOD	GOOD	GOOD
	SoftTouch	Contour	Small Area	Profile	Sealer Sanding	Flexible
NORTON	Softback	Contour	Full Size	High Flexibility	Woodworking	Pro Pads
3M	Single Side	–	Four Sided	–	Two Sided	–
Hermes	–	–	–	–	Foam Sanding Pad	–
Klingspor	–	–	–	–	Standard Pad	–
SIA	Flat Pad	–	Standard Block	–	–	–

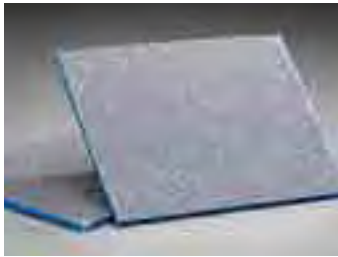

FEATURED PRODUCTS AND AVAILABILITY

**BETTER SOFTTOUCH CONTOUR SPONGES – COATED 1 SIDE**

- Superior flexibility; for hand-sanding or finishing flat, curved, contoured and hard-to-reach areas on wood, metal, composites, paint and solid surfaces
- Premium foam substrate provides for an extremely smooth and uniform sanded surface

SIZE (W x L x T)	GRIT	STD. PKG.	PART #
4-1/2 x 5-1/2 x 3/16	60 Medium	80	07660703074
	100 Fine	80	07660703075
	180 Super Fine	80	07660703076
	220 Ultra Fine	80	07660703077
	280 Micro Fine	80	07660703078

**GOOD CONTOUR SPONGES – COATED 1 SIDE**

- Thin, flexible; good for sanding small diameters and contours such as ceramics, spindles, turnings and railings

SIZE (W x L x T)	GRIT	STD. PKG.	PART #
4-1/2 x 5-1/2 x 3/16	100 Fine	100	07660702257
	150 Extra Fine	100	07660702256
	220 Ultra Fine	100	07660702255

**GOOD SMALL AREA GENERAL PURPOSE SPONGES – COATED 4 SIDES**

- Good for a wide variety of materials and sanding applications where moderate flexibility is needed
- Medium to firm density open cell polyurethane foam provides uniform support and moderately aggressive cutting action while generating a smooth surface

SIZE (W x L x T)	GRIT	STD. PKG.	PART #	BULK PKG.	PART #
4 x 2-3/4 x 1	36/80	24	07660749505	250	07660704735
	Ex. Coarse/Med				
	80/80	24	07660749507	250	07660701875
	Med/Med				
	80/120	24	07660749504	250	07660702600
	Med/Fine				
	120/120	24	07660749506		
	Fine/Fine				

**GOOD PROFILE SPONGES – COATED 3 SIDES**

- Good for corners and flat surfaces on wood, metal, plastic and paint
- Ideal for cabinet sanding of raised profile doors

SIZE (W x L x T)	GRIT	STD. PKG.	PART #
4 x 2-3/4 x 1/2	100 Medium	500	63642536313

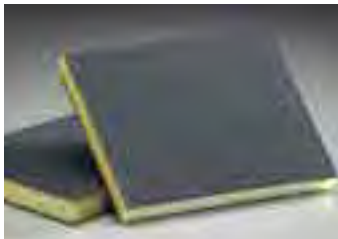
**GOOD SEALER SANDING SPONGES – COATED 2 SIDES**

- Very flexible; silicon carbide abrasive for sanding primers, sealers and between coats on furniture and cabinets

SIZE (W x L x T)	GRIT	BULK PKG.	PART #
4-3/4 x 3-3/4 x 1/2	80 Medium	250	63642502538
	100 Medium	250	63642552870
	150 Fine	250	63642552869
	220 Very Fine	250	63642552868

**GOOD FLEXIBLE ABRASIVE SPONGES – COATED 1 SIDE**

- Ideal for final sanding of surfaces, primer sanding, and between coats sanding
- Best initial price point for abrasive sponges

SIZE (W x L x T)	GRIT	STD. PKG.	PART #	BULK PKG.	PART #
3 x 4 x 1/2	60 Coarse	48	07660704068	108	07660701110
	80 Medium	48	07660704067	108	07660704070
	100 Medium	48	07660704066	108	07660700950
	150 Fine	48	07660704065	108	07660700949
	220 Very Fine			108	07660704069



CATEGORY DEFINITION

Norton flexible diamond coated hand pads combine the durability and aggressiveness of diamond, with a flexible backing.

APPLICATIONS: Diamond coated hand pads: Shaping, rapid stock removal, touch-up and repair on ceramics, stone, marble, glass, composites and hard materials; polishing of dies and molds.

Quadroflex diamond hand pads: Surface conditioning, repairs, and removing flash and burrs on aircraft composites and windmill blades.

SIZE RANGE: 3-1/2" x 2-1/8"

GRIT RANGE: 60 – 1500

ABRASIVE TYPES: Diamond

FEATURED PRODUCTS



FLEXIBLE DIAMOND COATED HAND PADS – CONVENTIONAL AND QUADROFLEX CURVED

BETTER CHOICE FOR SHAPING, RAPID STOCK REMOVAL, SURFACE CONDITIONING, TOUCH-UP, REPAIR, AND POLISHING

FEATURES	BENEFITS
<ul style="list-style-type: none"> Lightweight conformable backing 	<ul style="list-style-type: none"> Adaptable to a variety of shapes and conditions Durable, long life Uniform finishes; improved surface quality Can be used wet or dry No dressing required
<ul style="list-style-type: none"> Color coded 	<ul style="list-style-type: none"> Eases identification
<ul style="list-style-type: none"> Conventional hand pads: precision dot pattern 	<ul style="list-style-type: none"> Aggressive, consistent, fast cut rate, reduces dust and loading
<ul style="list-style-type: none"> Quadroflex curved hand pad 	<ul style="list-style-type: none"> Ergonomic advantages, overall lower cost

AVAILABILITY

SIZE (L x W)	COLOR	GRIT	STD. PKG.	TIER		TIER	
				BETTER		BETTER	
				DIAMOND COATED HAND PADS		QUADROFLEX CURVED DIAMOND COATED HAND PADS	
				Diamond		Diamond	
TRADENAME:	ABRASIVE:		PRODUCT NO.	PART #	PRODUCT NO.	PART #	
3-1/2 x 2-1/8	Green	60	1	HP60	66260306360	QHP60	69014121517
	Black	120	1	HP120	66260306361	QHP120	69014121518
	Red	200	1	HP200A	66260306362	QHP200	69014123529
	Yellow	400	1	HP400	66260305852	QHP400	69014123530
	White	800	1	HP800	66260306363	QHP800	69014123531
	Blue	1500	1	HP1500	66260306364		
	Kit (one each of above)		1	HPK-6	66260307720		



CATEGORY DEFINITION

Portable file belt sanders have replaced tedious hand filing and sanding. First introduced in pneumatic, they are now available in electric. Increasingly, tool manufacturers are introducing additional fixtures for an increasing number of applications. The belts listed are popular stock sizes, but additional sizes, specifications, backing materials, and edge scallops are available made-to-order.

- APPLICATIONS:** Light weld removal and blending, shape and contour sanding, surface preparation prior to coating and plating, removing cutting tool marks from molds and dies, general clean-up and finishing
- SIZE RANGE:** 1/8" to 1" wide, 12" to 30" long
- GRIT RANGE:** 40 – 120
- ABRASIVE GRAIN:** Ceramic Alumina, Zirconia Alumina, Aluminum Oxide

CROSS REFERENCE GUIDE

	BEST Blaze R980P	BEST Norton SG R981	BETTER BlueFire R887P/R823P	GOOD Metalite R283	GOOD Neon R766
NORTON					
3M	984F, 977F	963G, 967F	577F, 777F	241E	363F
Hermes	CR456	–	RB486 44 Z	RB317J, RB316EJ RB303 Flex	SB 378 YR
Klingspor	CS610YY	–	CS411YX, CS 409Y	CS310XF	CS412
SIA	–	–	–	933A, 936A	–
VSM	SK840X, SK750X	–	KK715X	KK711T, KK511J	KK711

MATERIAL-TO-PRODUCT RECOMMENDATION GUIDE

	HEAVY-DUTY		GENERAL-DUTY
	BEST Highest Productivity – Lowest Total Cost.	BETTER Excellent Blend of Performance & Price	GOOD Consistent Performance – Low Initial Price
Carbon Steel	Norton Blaze R980P	Norton BlueFire R887P/R823P	Norton Neon R766
Stainless Steel / Alloys	Norton Blaze R980P	Norton BlueFire R887P/R823P	Norton Neon R766
Cast Iron	Norton Blaze R980P	Norton BlueFire R887P/R823P	Norton Neon R766
Brass/Bronze	–	Norton BlueFire R887P/R823P	Norton Neon R766
Aluminum	–	Norton BlueFire R887P/R823P	Norton Neon R766

FEATURED PRODUCTS



NORTON BLAZE R980P

BEST FOR STAINLESS, COBALT, CHROME, INCONEL, TITANIUM, MILD AND CARBON STEEL

FEATURES

- Next-generation cooler cutting Norton SG ceramic alumina grain
- Y-weight polyester waterproof cloth backing
- Improved resin bond system
- Advanced "supersize" grinding lubricant

BENEFITS

- Lasts 50% to 200% longer on mild and carbon steel, stainless, cobalt, chrome, Inconel and titanium
- Better metal integrity
- Edge-fray resistance
- Improved body-retention during use for more consistent grinding throughout belt life
- Significantly improved belt life due to exceptional grain adhesion
- Cooler cutting during the life of the belt
- Improved part finish and integrity



FEATURED PRODUCTS



NORTON BLUEFIRE R887/R823P
THE BETTER CHOICE FOR STAINLESS AND CARBON STEEL

FEATURES

BENEFITS

- High-performance, self-sharpening zirconia alumina abrasive
- High-performance resin bond
- Strong Y-weight polyester backing - R887P
- Flexible X-weight polyester backing - R823P
- Industry-leading cut rate and life
- Strong grain adhesion, longer life
- For heavy-duty stock removal applications
- For moderate- to light-pressure applications



NORTON NEON R766
THE BETTER CHOICE FOR DIFFICULT-TO-GROUND MATERIALS (ALUMINUM, BRASS, BRONZE, STAINLESS, CARBON STEEL, TITANIUM, ETC.)

FEATURES

BENEFITS

- Premium abrasive and aluminum oxide blend
- Resin bond system
- Y-weight waterproof polyester backing
- Ideal when purchasing criteria is a good-performing, economically priced, general purpose belt
- Improved edge retention and 30% + improvement in life vs. key competitors
- Withstands light- to moderately-demanding applications
- Extended life on dry grinding applications

AVAILABILITY

TIER:	BEST	BEST	BETTER	GOOD	GOOD
BRAND:	Norton	Norton	Norton	Norton	Norton
TRADENAME:	BLAZE R980P	NORTON SG R981	BLUEFIRE R887/R823P	METALITE R283	NEON R766
ABRASIVE:	Ceramic Alumina	Ceramic Alumina	Zirconia Alumina	Aluminum Oxide	Premium A/O Blend
BACKING:	Y-wt. Polyester	Y-wt. Polyester	Y-wt./X-wt. Polyester	X-wt. Rayon	Y-wt. Polyester
OTHER:	Supersize				

SIZE (W x L)	GRIT	STD. PKG.	PART #	PART #	PART #	PART #	PART #
12" Belts							
1/8 x 12	40	50	66254491518	66254491521	66254492520	66254491536	66623390000
	60	50	66254405345	66254491522	66261093029	66254491537	66623390001
	80	50	66261089479	66254491523	66261093030	66254491538	66623390002
	120	50	66254491519	66254491524	66254491533	66254491539	66623390003
1/4 x 12	40	50	66254491520	66254491525	78072758896	78072727557	66623390004
	60	50	66261196480	78072760823	66623373744	66254491540	66623390005
	60	25 ✓			78072782621	78072727555	
	80	50	66261063617	66254491526	66623373745	78072727554	66623390009
	8	25 ✓			78072782622		
	120	50	66261063632	66254491527	66623373746	78072763175	
1/2 x 12	40	50	69957398018	66254491528	66254492522	78072727557	66623390006
	50	50	66261043759	78072718700	66254492523	66254491540	66623390007
	60	50	69957398019	78072718701	78072728745	78072727555	66623390008
	60	25 ✓			66623373753		
	80	50	69957398020	78072718702	78072728744	78072727554	66623390009
	80	25 ✓			66623373754		
	100	50	66261081180	66254491529	66254491534	78072727553	
	120	50	66261042909	78072700518	78072728742	78072727552	
1 x 12	60	50	66261063641		66623373755	78072773813	66623390010
	120	25 ✓			78072753073		
13" Belts							
3/8 x 13	60	50	69957345359	78072745459	78072740295	78072732112	66623390011
	80	50	69957392150	78072774916	78072736062	78072771323	66623390012
18" Belts							
1/8 x 18	40	50	66254475211		66254492524	66254491541	66623390013
	60	50	66261080010		66254491535		66623390014
	80	50	66261089120	78072789083	78072760595	63642594761	66623390015
	120	50	66254475215	78072789084	63642595221	66254491542	

CONTINUED



AVAILABILITY

TIER:	BEST	BEST	BETTER	GOOD	GOOD
BRAND:	Norton	Norton	Norton	Norton	Norton
TRADENAME:	BLAZE R980P	NORTON SG R981	BLUEFIRE R887/R823P	METALITE R283	NEON R766
ABRASIVE:	Ceramic Alumina	Ceramic Alumina	Zirconia Alumina	Aluminum Oxide	Premium A/O Blend
BACKING:	Y-wt. Polyester	Y-wt. Polyester	Y-wt./X-wt. Polyester	X-wt. Rayon	Y-wt. Polyester
OTHER:	Supersize				



SIZE (W x L)	GRIT	STD. PKG.	PART #	PART #	PART #	PART #	PART #
18" Belts (continued)							
1/4 x 18	40	50	66261027923	66261198953	66254492525	66254491543	66623390016
	60	50	69957347249	78072774684	78072743583	78072771000	66623390017
	60	25 ✓			66623373747		
	80	50	69957346155	78072703284	78072753075	78072773921	66623390018
	80	25 ✓			66623373748		
	120	50	66261085071	78072785655	78072773764		
1/2 x 18	40	50	69957398021	78072766018	66254444193	78072727561	66623390019
	60	50	69957398022	78072718704	78072728569	78072727560	66623390020
	60	25 ✓			66623373756		
	80	50	69957398023	78072718705	78072728568	78072727559	66623390021
	80	25 ✓			66623373757		
	120	50	66261041384	78072718706	78072728567	78072727558	
3/4 x 18	40	50	69957398027	78072762476	66254492526	78072781797	66623390022
	60	50	69957398028	78072745691	78072709590	78072739966	66623390023
	60	25 ✓			66623373762		
	80	50	69957398029	78072756309	78072758953	78072732289	66623390024
	80	25 ✓			66623373763		
	120	25 ✓			66623373764		
20-1/2" Belts							
3/4 x 20-1/2	40	50	69957398030	78072714398	66254457869	78072727573	66623390025
	50	50	69957344982	78072718714	66254492527	66254491544	66623390026
	60	50	69957398031	78072718715	78072728560	78072727571	66623390027
	60	25 ✓			66623373765		
	80	50	69957398032	78072718716	78072728559	78072727570	66623390028
	80	25 ✓			66623373766		
	100	50	66261055516	78072771151	66261038911	78072727569	
	120	50	66261044755	78072727380	78072728557	78072727575	
	120	25 ✓			66623373767		
24" Belts							
1/4 x 24	40	50	66261198631	78072747823	66254473499	66254401929	66623390029
	60	50	69957345451	78072756534	78072728552	78072727548	66623390030
	60	25 ✓			66623373750		
	80	50	63642596940	78072718340	78072767713	66261085068	66623390031
	80	25 ✓			66623373751		
	120	50	66261080367	78072770718	78072728550	66261085069	
1/2 x 24	40	50	69957398024	78072760092	66254492528	78072727568	66623390032
	50	50	66261043757	78072718707	66254452237	78072727567	66623346910
	60	50	69957398025	78072718708	78072728564	78072727566	66623390033
	60	25 ✓			66623373759		
	80	50	69957398026	78072718709	78072728566	78072727565	66623390034
	80	25 ✓			66623373760		
	100	50	66261042203	78072745021	78072753076	66254491545	
	120	50	66261042565	78072718710	78072728565	78072727564	
	120	25 ✓			66623373761		
1 x 24	40	50	69957350019	66254491531	66254492529	66254491546	66623390035
	50	50	69957344889	78072710374	66254492530	66254491547	66623390036
	60	50	69957353375	78072737318	78072798720	66254491548	66623390037
	80	50	69957345419	78072772209	78072776498	66261085068	66623334206
	120	50	66261085067	66254491532	78072730029	66261085069	
30" Belts							
1 x 30	40	50	66261053470	78072765229	66254478257	66261189958	66623390038
	60	50	69957345985		78072728583	66254491549	66623390039
	80	50	69957346105	78072764439	78072728582	78072727579	66623390040
	120	50	66261193676	78072781197	78072766992	78072727577	

ADDITIONAL SIZES, GRITS AND SCALLOPED EDGE BELTS ARE AVAILABLE MTO (MADE-TO-ORDER). PLEASE CONTACT YOUR LOCAL NORTON DISTRIBUTOR TO CHECK AVAILABILITY. 40 AND 50 GRIT BLUEFIRE BELTS ARE FURNISHED IN BLUEFIRE R887 (Y-WT POLYESTER); 60-120 GRITS ARE SUPPLIED IN BLUEFIRE R823P (X-WT. POLYESTER). JOINTS AND FLEXES – ALL BELTS ARE PG JOINTED; A BUTT JOINT JOINED WITH FLEXIBLE TAPE FOR CONTOUR GRINDING.

✓ = VENDIBLE PACKAGE. IDEAL FOR VENDING MACHINES AND SMALL JOBS. 5 BELTS PER PACK / 5 PACKS PER CARTON. ORDER IN MULTIPLES OF 25.



CATEGORY DEFINITION

Portable belts are ideal for all your metal and woodworking applications. Choose 36 – 50 grits for rough/heavy-duty applications, 60 – 100 for intermediate, and 100 – 220 for finishing/polishing applications.

- APPLICATIONS:** Grinding and finishing all metals, blending welds, sanding and finishing wood, glass seaming, and polishing
- SIZE RANGE:** 3" to 4" wide, 15-1/2" to 24" long
- GRIT RANGE:** 36 – 220
- ABRASIVE GRAIN:** Ceramic Alumina, Zirconia Alumina, Aluminum Oxide

CROSS REFERENCE GUIDE

	BEST Norton SG R981	BETTER BlueFire R831	GOOD Metalite R215/R228/R255
NORTON			
3M	977F, 967F, 963G	777F, 577F	241D, 340D
Hermes	RB346MX	RB484Z	RB316XOP
Klingspor	CS610YY	CS411Y	CS311YX, CS310X, LS309XH
Sait	–	ZH	AOX, IAX
SIA	–	–	2903XO, 2905X, 2920X
VSM	SK855X	ZK713X	KK511X, KK711X, KK504X

MATERIAL-TO-PRODUCT RECOMMENDATION GUIDE

	HEAVY-DUTY	GENERAL-DUTY	
	BEST Highest Productivity – Lowest Total Cost	BETTER Excellent Blend of Performance & Price	GOOD Consistent Performance – Low Initial Price
Wood	–	Norton NorZon R831	Norton Metalite R215/R255
Stainless Steel / Carbon Steel	Norton SG R981	Norton NorZon R831	Norton Metalite R228
Brass / Bronze / Aluminum	–	Norton NorZon R831	Norton Metalite R215/R255

FEATURED PRODUCTS



NORTON SG R981
EXCEPTIONAL PERFORMANCE, ESPECIALLY ON HARD-TO-GRIND ALLOYS

FEATURES	BENEFITS
■ Norton SG ceramic abrasive	■ Exceptional life and value, especially on hard-to-grind alloys
■ Grinding-aid enhanced	■ Longer life, cooler cut
■ Strong Y-weight polyester, waterproof cloth backing	■ Improved grain adhesion, reduced edge-fray, and better body retention result in longer life and product consistency



NORTON BLUEFIRE R831
THE BETTER CHOICE FOR STAINLESS STEEL AND WOOD

FEATURES	BENEFITS
■ Premium, self-sharpening zirconia alumina	■ Aggressive abrasive, rapid cut rate, long life
■ Reversible butt splice	■ Use in either direction for longer life
■ Open-coat design, strong Y-weight cotton backing	■ Reduced loading, extended life
■ Packaged in convenient job packs	■ Ideal for small jobs, carrying cleanly to job sites, and mounting on showroom displays





Portable Belts for Belt Sanders

Portable electric belt sanders are used on wood, metal, and other materials, for applications ranging from stock removal to finishing. They consist of an electrical motor that turns a pair of drums on which an abrasive belt is mounted.

Belt sanders can be either hand-held, where the sander is moved over the material, or stationary (fixed), where the material is brought to the sanding belt.

AVAILABILITY

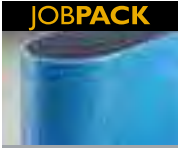
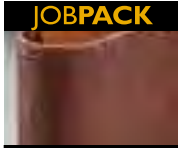

			
TIER:	BETTER	GOOD	GOOD
BRAND:	Norton	Norton	Norton
TRADENAME:	BLUEFIRE R831	METALITE R255	METALITE R255
ABRASIVE:	Zirconia Alumina	Aluminum Oxide	Aluminum Oxide
JOINT:	Plyweld	Plyweld	Plyweld
GRAIN COATING:	Open Coat	Open Coat	Open Coat
OTHER:			UPC Bar Coded





SIZE (W x L)	GRIT	STD. PKG.	PART #	PART #	STD. PKG.	PART #
3 x 18	36				5	78072780447
	50	5*	07660749259	07660700964	10	78072727994
	80	5*	07660749258	07660700968	10	78072727993
	120	5*	07660749256	07660700969	10	78072727992
3 x 21	36	5*	07660749266	07660701741		
	40				10	78072727927
	50	5*	07660749265	07660701740	10	78072727926
	60				10	78072727925
	80	5*	07660749264	07660702064	10	78072727924
	100	5*	07660749263		10	78072727923
	120	5*	07660749262	07660702062	10	78072727922
	220	5*		07660705287		
3 x 24	36	5*	07660749272	07660701743	5	78072781847
	40				10	78072727937
	50	5*	07660749271	07660701742	10	78072727936
	60				10	78072727935
	80	5*	07660749270	07660702067	10	78072727934
	100	5*	07660749269	07660702066	10	78072727933
	120	5*	07660749268	07660702065	10	78072727932
4 x 24	36	5*	07660749278	07660701745	5	78072780438
	40				10	78072727947
	50	5*	07660749277	07660701744	10	78072727946
	60				10	78072727945
	80	5*	07660749276	07660702069	10	78072727944
	100	5*	07660749275		10	78072727943
	120	5*	07660749274	07660702068	10	78072727942
	180	5*		07660705285		

*JOB PACK PACKING STANDARDS: 5 BELTS/JOB PACK; 5 JOB PACKS PER CARTON. ORDER BY NUMBER OF PACKS, IN MULTIPLES OF 5 PACKS.

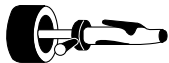
Portable Belts for Pneumatic In-Line Drum Sanders

AVAILABILITY



				
TIER:	BEST	BETTER	GOOD	GOOD
BRAND:	Norton	Norton	Norton	Norton
TRADENAME:	SG R981	BLUEFIRE R823P	METALITE R215	METALITE R228
ABRASIVE:	Ceramic Alumina	Zirconia Alumina	Aluminum Oxide	Aluminum Oxide
JOINT:	Plyweld	Plyweld	Plyweld	Plyweld
GRAIN COATING:	Close Coat/Supersize	Close Coat	Open Coat	Closed Coat

SIZE (W x L)	GRIT	STD. PKG.	PART #	PART #	PART #	PART #
3-1/2 x 15-1/2	36	10	78072700783		78072721997	
	60	10	78072718750		78072722000	
	80	10	78072718751	78072753074		78072721995
	120	10	78072718753			



CATEGORY DEFINITION

A wide selection of sizes and grits for most dimensioning, intermediate grinding and polishing applications.

APPLICATIONS: Benchstand and Backstand Belts: grinding and deburring of all metals, heavy stock removal, blending, dimensioning and shaping, polishing.

Centerless, Conveyor and Platen Belts: intermediate grinding stainless and carbon, moderate-pressure applications, dimensioning and finishing.

SIZE RANGE: 1" to 10" wide, 36" to 132" long

GRIT RANGE: 36 – 320

ABRASIVE GRAIN: Ceramic Alumina, Zirconia Alumina, Aluminum Oxide

CROSS REFERENCE GUIDE

	BEST Blaze R980P	BEST Norton SG R981	BETTER BlueFire R887P	BETTER BlueFire R821P	BETTER BlueFire R823P	BETTER BlueFire R884P	GOOD Metalite R228
NORTON 3M	987F1, 977F, 777F, 967F, 963G, 963H, 984F	987F1, 977F, 777F, 967F, 963G, 963H	577F, 567G, 777F, 977F	561D	561F Y, 551E XE, 741A, 741E, 761D	561D, 561F, 563F, 741A, 741E, 761D, 761F	240DZ OPK, 270DZ OPK, 241D, 248D, 251D, 341I Imperial, 351D
Hermes	CR456	CR456	RB486X, RB486Y, RB426-23MX	–	RB486 X, RB346-23MX, RB426-23MX, RB484TY, RB486XF	RB484TY, RB486Y, RB346-23MX, RB426-23MX, RB480-21MX, CB440Y, RB486XY	RB3160P, RB317LX, RB346MX
Klingspor	CS612YY, CS610YY	CS612YY, CS610YY	CS409Y	CS411Y	CS411X	CS411Y	CS311X, CS310, CS410
SIA	–	–	–	–	–	2800, 2803, 2929	2903XO, 2905X, 2920X
VSM	SK840X, SK750X	SK840X, SK750X	KK815Y, ZK744X	–	KK715X	KK716Y, ZK713X	KK511X, KK711

MATERIAL-TO-PRODUCT RECOMMENDATION GUIDE

	BEST Highest Productivity. Lowest Total Cost.	BETTER Excellent Blend of Performance & Price.	GOOD Consistent Performance. Low Initial Price.
Aluminum	–	Norton BlueFire R884P/R823P	Norton Neon R766
Cast Iron	Norton Blaze R980P	Norton BlueFire R823P	Norton Neon R766
Brass / Bronze	–	Norton BlueFire R884P/R823P	Norton Neon R766
Die Castings	Norton Blaze R980P	Norton BlueFire R823P	Norton Neon R766
Carbon Steel	Norton Blaze R980P	Norton BlueFire R823P	Norton Neon R766
Glass / Ceramics	Norton Blaze R980P	Norton BlueFire R821P	Norton Neon R766
Stainless Steel and Alloys	Norton Blaze R980P	Norton BlueFire R823P/R887P	Norton Neon R766
Wood	–	Norton BlueFire R831/R884P	Norton Neon R766

GRIT SELECTION RECOMMENDATION GUIDE

STOCK REMOVAL	INTERMEDIATE	FINISHING
36 – 50 grit	60 – 100 grit	120 – 320 grit



FEATURED PRODUCTS

**NORTON BLAZE R980P**

BEST FOR MILD AND CARBON STEEL, STAINLESS, COBALT, CHROME, INCONEL, TITANIUM

FEATURES

- Cooler cutting Norton SG ceramic abrasive grain
- Y-weight polyester waterproof cloth backing
- Durable resin bond system
- Advanced "supersize" grinding lubricant

BENEFITS

- Lasts 50% to 200% longer on mild and carbon steel, stainless, cobalt, chrome, Inconel and titanium versus aluminum oxide belts
- Cuts 20% faster than the current generation of grinding belts
- Longer belt life
- Better metal integrity
- Greater productivity; lowest total grinding costs
- Edge-fray resistance
- Excellent body retention during use for more consistent grinding throughout belt life
- Significantly improved belt life due to better grain adhesion
- Cooler cutting during the life of the belt
- Improved part finish and integrity

**NORTON SG R981**

EXCEPTIONAL PERFORMANCE, ESPECIALLY ON HARD-TO-GRIND ALLOYS

FEATURES

- Norton SG ceramic abrasive
- Grinding-aid enhanced
- Strong Y-weight polyester, waterproof cloth backing

BENEFITS

- Exceptional life and value, especially on hard-to-grind alloys
- Longer life, cooler cut
- Improved grain adhesion, reduced edge-fray and better body retention, result in longer life and product consistency



EXPANDED OFFERING

NORTON BLUEFIRE R884P/R823P

BETTER CHOICE FOR HEAVIEST-PRESSURE APPLICATIONS

FEATURES

- Premium self-sharpening zirconia alumina abrasive
- R884P – Durable Y-weight polyester, waterproof cloth backing
- R823P – Strong X-weight polyester backing; waterproof

BENEFITS

- Aggressive, rapid cut rate
- Excellent grain adhesion, reduced edge-fray and better body retention, result in longer life and product consistency
- More flexible than R884P
- Available in finer grit sizes

**NORTON NEON R766**

THE BETTER CHOICE FOR DIFFICULT-TO-GRIND MATERIALS (ALUMINUM, BRASS, BRONZE, STAINLESS, CARBON STEEL, TITANIUM, ETC.)

FEATURES

- Premium abrasive and aluminum oxide blend
- New resin bond system
- Y-weight waterproof polyester backing

BENEFITS

- Ideal when purchasing criteria is a good-performing, economically priced, general purpose belt
- Improved edge retention and 30% + improvement in life versus key competitors
- Withstands light- to moderately-demanding applications
- Extended life on dry grinding applications

TECHtip

TROUBLESHOOTING GUIDE

PROBLEM**Loading****Shedding****Belt breakage****CORRECTION**

Decrease infeed pressure or belt speed

Reduce applied pressure

Use a less aggressive contact wheel

Dress contact wheel if worn or damaged

Use entire surface of belt

Reduce belt tension

Use less aggressive contact wheel

Check tracking mechanism for belts tracking erratically



1" to 6" wide, 36" to 72" long

AVAILABILITY



TIER:	BEST	BETTER	BETTER	GOOD	GOOD
BRAND:	Norton	Norton	Norton	Norton	Norton
TRADENAME:	BLAZE R980P	BLUEFIRE R821P	BLUEFIRE R823P	NEON R766	METALITE R228
ABRASIVE:	Ceramic Alumina	Zirconia Alumina	Zirconia Alumina	Premium A/O Blend	Aluminum Oxide
BACKING:	Y-wt. Polyester	Y-wt. Cotton	X-wt. Polyester	Y-wt. Polyester	X-wt. Cotton

SIZE (W x L)	GRIT	STD. PKG.	PART #	PART #	PART #	PART #	PART #
1 x 42	36	50	66254476825				78072791710
	40	50	69957345887	78072726905		66623390041	78072720910
	50	50	66254476826	78072726904		66623390042	78072720905
	60	50	69957345486	78072726903	78072728596	66623334502	78072720900
	80	50	66261041539	78072726902	78072728594	66623390043	78072720895
	100	50	66261043462		78072728592		78072720890
	120	50	66261038660		78072728590		78072720885
	150	50			78072728588		78072720880
	180	50			78072728586		78072720875
	220	50			78072700001		78072720871
	240	50					78072720870
	320	50					78072720865
1-1/2 x 60	36	10	69957345578				78072721060
	40	10	63642595003				
	50	10	69957345664			66623390044	78072787807
	60	10	69957345631			66623390045	
	80	10	69957345579			66623390046	
	100	10			78072765077		69957351736
	120	10	66261056493		78072726984		
	220	10			78072758464		
2 x 48	24	10					78072756615
	36	10	63642592057	78072727103		66623390047	78072726130
	40	10	69957345193	78072727102		66623390048	78072721255
	50	10	69957346716	78072727101		66623390049	78072721250
	60	10	69957344423	78072727100	78072728621	66623390050	78072721245
	80	10	69957345100	78072727099	78072728619	66623390051	78072721240
	100	10	66261052522		78072728617		78072721235
	120	10	66261052520		78072728615		78072721230
	150	10			78072728615		78072721225
	180	10			78072728613		78072721225
	220	10			78072728611		78072721223
	320	10			78072728609		78072763677
2 x 60	24	10					78072746387
	36	10	69957345196			66623390052	66261054787
	40	10	69957394425	78072727124		66623390053	78072701170
	50	10	69957346149			66623390054	78072721300
	60	10	69957344901	78072727122		66623390055	78072762537
	80	10	63642592574	78072727121		66623390056	78072721290
	100	10	66261052222		66261082976		78072721285
	120	10	66261042738		78072761958		78072721280
	150	10					78072744018
	180	10			78072702695		78072720441
	220	10			78072706282		78072744020
	320	10					78072761862
2 x 72	24	10	66254433969				78072702825
	36	10	69957345460	78072727147		66623390057	78072721335
	40	10	69957346729	78072727146		66623390058	78072721332
	50	10	69957344966	78072727145		66623390059	78072784894
	60	10	69957345157	78072727144	78072728645	66623390060	78072721325
	80	10	69957344961	78072727142	78072728643	66623334237	78072721320
	100	10	66261041897		66261025537		78072723235
	120	10	66261044095		78072728639		78072721318
	150	10			78072761770		78072761973
	180	10			78072763853		78072718488
	220	10			78072728633		78072765601
	320	10					78072721308

CONTINUED...



1" to 6" wide, 36" to 72" long CONTINUED

AVAILABILITY



TIER:	BEST	BETTER	BETTER	BETTER	GOOD	GOOD
BRAND:	Norton	Norton	Norton	Norton	Norton	Norton
TRADENAME:	BLAZE R980P	BLUEFIRE R821P	BLUEFIRE R823P	BLUEFIRE R884P	NEON R766	METALITE R228
ABRASIVE:	Ceramic Alumina	Zirconia Alumina	Zirconia Alumina	Zirconia Alumina	Premium A/O Blend	Aluminum Oxide
BACKING:	Y-wt. Polyester	Y-wt. Cotton	X-wt. Polyester	Y-wt. Polyester	Y-wt. Polyester	X-wt. Cotton

SIZE (W x L)	GRIT	STD. PKG.	PART #	PART #	PART #	PART #	PART #	PART #
2-1/2 x 48	36	10						66623390061
	40	10						66623390062
	50	10						66623390063
	60	10						66623390064
	80	10						66623390065
2-1/2 x 60	24	10				78072737759		78072708296
	36	10	69957344963	78072727235			66623390066	78072721610
	40	10	69957346523	78072727234			66623390067	78072721605
	50	10	69957345300	78072727233			66623390068	78072721600
	60	10	69957345002	78072727232	78072728692	78072721383	66623390069	78072721595
	80	10	69957346095	78072727231	78072728690		66623390070	78072721590
	100	10			78072768991			78072721585
	120	10			78072728686			78072721580
	150	10						78072710118
	180	10			78072728682			78072721570
220	10			78072778217			78072721565	
4 x 36	36	10					66623390071	78072722110
	40	10					66623390072	78072722105
	50	10		78072727475			66623390073	78072722100
	60	10			78072728827		66623390074	78072722095
	80	10		78072727473	78072728825		66623390075	78072722090
	100	10			78072728823			78072722085
	120	10			78072728821			78072722080
	150	10						78072722079
	180	10						78072722075
	240	10						78072722926
320	10						78072722071	
4 x 54	36	10	69957346358				66623390076	78072722185
	40	10	63642594113				66623390077	78072722180
	50	10	66254469595				66623390078	78072722175
	60	10	66261063419	78072727518	78072725116		66623390079	78072722170
	80	10	69957345139		78072782996		66623390080	78072722165
	100	10						78072722160
	120	10	66261088705		78072728847			78072722155
	150	10						78072728381
180	10						78072759243	
220	10						78072762536	
4 x 60	24	10	66254461488					78072772342
	36	10	69957345298			78072737955		78072705189
	40	10	69957391732					78072744693
	50	10	69957346715					78072761630
	60	10	63642594485		78072774790			78072762861
	80	10	69957345099		78072765086			78072784685
	100	10						78072763161
	120	10	66254416188		78072766229			78072787840
	150	10						78072704878
	180	10			78072709820			78072728393
220	10			78072702594			78072790168	
4 x 72	36	10				78072725984		
6 x 48	36	10	69957345143	78072727698			66623390081	78072722590
	40	10		78072727697			66623390082	
	50	10		78072727696			66623390083	78072722580
	60	10	69957344422	78072727695*	78072728937*		66623390084	78072722570
	80	10		78072727694*	78072728935*		66623390085	78072722565
	100	10			78072728933*			78072722560
	120	10			78072728931*			78072722555
	150	10			78072770042			78072722550
	180	10						78072722546
	220	10						78072722545
	240	10						78072722543
	320	10						

* STD. PKG. = 20 BELTS

CONTINUED...



1" to 6" wide, 36" to 72" long CONTINUED

AVAILABILITY

SIZE (W x L)	GRIT	STD. PKG.	PART #	PART #	PART #	PART #	PART #	PART #
6 x 54	60	10				78072746982		
6 x 60	36	10						78072722680
	40	10		78072727762				78072722679
	60	10	69957345149	78072728957*				78072722665*
	80	10			78072728955			78072722660*
	100	10	66254477452					
	120	10						78072763882



TIER:	BEST	BETTER	BETTER	BETTER	GOOD	GOOD
BRAND:	Norton	Norton	Norton	Norton	Norton	Norton
TRADENAME:	BLAZE R980P	BLUEFIRE R821P	BLUEFIRE R823P	BLUEFIRE R884P	NEON R766	METALITE R228
ABRASIVE:	Ceramic Alumina	Zirconia Alumina	Zirconia Alumina	Zirconia Alumina	Premium A/O Blend	Aluminum Oxide
BACKING:	Y-wt. Polyester	Y-wt. Cotton	X-wt. Polyester	Y-wt. Polyester	Y-wt. Polyester	X-wt. Cotton

* STD. PKG. = 20 BELTS

Belt Cleaning Stick



- This solid, rubber cleaning stick is designed to remove wood and other non-metallic materials that build up on belt surface during use.
- Apply it to the face of the belt, while running, to remove unwanted materials and prolong the overall life of the belt up to 10 times.

DESCRIPTION	STD. PKG.	PART #
1-3/8 x 1-3/8 x 6	10	07660701717

TECHtip

A light bodied grease applied to a benchstand belt surface will reduce loading and greatly enhance the belt life and performance when grinding soft, malleable nonferrous materials such as aluminum, brass, bronze and copper.

FastTrack Belt Service



For non-stock belts, FastTrack Service Centers offer all the benefits of an ISO 9001 quality manufacturer and the advantages of a coated abrasives express belt service. As the industry's leading producer of abrasive material and backings, our FastTrack service offers an extensive range of Norton made-to-order belts including Norton SG ceramic alumina, BlueFire zirconia alumina, and versatile aluminum oxide and silicon carbide belts.

Manufacturing lead-time is two days for narrow belts (1/2"- 12" widths) and three days for wide belts =>14" width. Please see the FastTrack Service belt section for complete availability and lead-times.





2" to 10" wide, over 70" Long

AVAILABILITY



TIER:	BEST	BEST	BETTER	BETTER	GOOD	GOOD
BRAND:	Norton	Norton	Norton	Norton	Norton	Norton
TRADENAME:	BLAZE R980P	SG R981	BLUEFIRE R884P	BLUEFIRE R823P	NEON R766	METALITE R228
ABRASIVE:	Ceramic Alumina	Ceramic Alumina	Zirconia Alumina	Zirconia Alumina	Premium A/O Blend	Aluminum Oxide
BACKING:	Y-wt. Polyester	Y-wt. Polyester	Y-wt. Polyester	X-wt. Polyester	Y-wt. Polyester	X-wt. Cotton

SIZE (W x L)	GRIT	STD. PKG.	PART #	PART #	PART #	PART #	PART #	PART #
2 x 132	36	10		78072753086	78072750016		66623347337●	
	40	10			78072750015		66623390089●	
	50	10		78072740771	78072750013		66623390090●	
	60	10			78072750011		66623390091‡	78072721445
	80	10		78072701958	78072750008		66623390092‡	78072721440
	120	10				78072728662		
3 x 79	50	10	66261090276		78072748280			
	60	10			78072731833			
3 x 90	24	10						
	36	10	69957346319					78072785831
3 x 132	24	10	69957344962●		78072750140			
	36	10	69957344710●	78072753087	78072750138 RR		66623390093	78072721900
	36	10			78072750139 L			
	40	10	69957344964●	78072701614			66623390094●	
	50	10	69957344763●	78072703709	78072750135		66623390095●	78072721890
	60	10	69957344958‡			78072728794	66623390096‡	78072721885
	80	10	69957344764‡			78072728792	66623390097‡	78072721880
	100	10				78072728790		
	120	10				78072728789		78072721870
	150	10						78072721865
4 x 79	36	10		66261022622				78072721860
	40	10			78072774955			
4 x 100	80	10			78072731327			
	36	10			78072768679			
4 x 132	24	10			78072750289			
	36	10	69957343852●	78072739662	78072750287		66623326093	
	40	10					66623390098	
	60	10			78072750281		66623335394‡	
	80	10			78072750279		66623343488‡	78072722385
	120	10						78072722375
6 x 78-3/4	40	10			78072725150			
6 x 79	36	10			78072738105			
	40	10			78072760469			
	80	10			78072779322			
8 x 107	36	10					66623390099	78072722795
	50	10					66623390100	78072749887
	60	10					66623347341	78072722780*
	80	10					66623329182	78072722775*
	100	10						
10 x 70-1/2	36	10					66623347342	78072722840
	40	10					66623347343	78072722835
	50	10					66623347344	78072722830
	60	10					66623347345	78072722825
	80	10					66623347346	78072722820

* STD. PKG. = 20 BELTS
 ● STD. PKG. = 25 BELTS
 ‡ STD. PKG. = 50 BELTS



CATEGORY DEFINITION

A small selection of stock products in popular sizes are available for wide belt woodworking and metalworking applications.

APPLICATIONS: Metalworking wide belts are used for plate dimensioning, slag grinding, machining, deburring, and other general metalworking applications. They are usually cloth and are closed coat.

Cloth woodworking wide belts are used for rough stock removal and dimensioning; paper woodworking belts are used to upgrade the finish on furniture and other wood components.

SIZE RANGE: Stock: 25" – 52" wide, 48" to 103" long

GRIT RANGE: Stock: 36 – 220

ABRASIVE GRAIN: Ceramic Alumina, Zirconia Alumina, Aluminum Oxide

AVAILABILITY: Due to the wide varieties of machines and applications, the majority of wide belts are non-stock. Our FastTrack belt service is available on the majority of products with 3-day lead-time on orders up to two standard packages.

METALWORKING CLOTH BELT RECOMMENDATION GUIDE/CROSS REFERENCE

	TOTAL PERFORMANCE ←					→ INITIAL PRICE		
	BEST HIGHEST PRODUCTIVITY LOWEST TOTAL COST		BETTER EXCELLENT BLEND OF PERFORMANCE & PRICE			GOOD CONSISTENT PERFORMANCE LOW INITIAL PRICE		
	H-wt. Poly	Y-wt. Poly	H-wt. Poly	Y-wt. Poly	X-wt. Poly	Y-wt. Poly	X-wt. Poly	X-wt. Cotton
NORTON	R940P	R980P	R840P	R887P/R884P	R823P	R247	R249	R228
MERIT		SY965		SY695	SX695	SY395	SX395	KX375
3M	963G,H	977F, 967F		577F, 777F		361F	353F	241D, 341D
Ekamant				UZA0X	UZA0X	UA0X	UA0X	MX, RKX
Hermes	CB441Z	CR456	SB488Y OP	RB484TY	RB486	RB376TY	RB376TY	RB346MX
Klingspor		CS610YY	CS414YY	CS411Y	CS411Y	CS412Y	CS412Y	CS310X
SIA			C888 DP	2800, 2803		2982		2920, 2912
VSM	SK770X, SK847Y,	SK840X	KK717Y	KK716Y	KK715X	KK711Y	KK711X	KK511X

WOODWORKING CLOTH BELT RECOMMENDATION GUIDE/CROSS REFERENCE

	TOTAL PERFORMANCE ←				→ INITIAL PRICE		
	BEST HIGHEST PRODUCTIVITY LOWEST TOTAL COST		BETTER EXCELLENT BLEND OF PERFORMANCE & PRICE		GOOD CONSISTENT PERFORMANCE LOW INITIAL PRICE		
	Y-wt. Cotton Dust-Less	F-wt. Paper Dust-Less	Y-wt. Cotton	Y-wt. Cotton Dust-Less	X-wt. Cotton	F-wt. Paper Dust-Less	F-wt. Paper Dust-Less
NORTON	R963	H975	R831	R216	R215	H295	H275
MERIT			KY685		KX395	P55F	P55FOP
3M	970DZ	961UZ	777F	240D, 248D, 370DZ	240DZ, 340D	260UZ	241
Ekamant					PKX, RKX		PKFO, APKFO
Hermes		CB115	RB484TY, RB346MX	RB316YOP, RB372YOP	RB316XOP	BW112	BW114
Klingspor			CS414Y, SMT624	CS412, CS311Y	CS3110C	PS26	PS20
SIA	2829	1919	2803, 2820, 2829	2918, 2920, 2928	2928, 2920	1919FO	1939
VSM			KK716X	KK711Y, KK524Y	KK504X	KK508E	KP709

FEATURED PRODUCTS



NORTON BLUEFIRE R884P/R831/R823P CLOTH BELTS

BETTER CHOICE FOR ALL METAL AND WOOD APPLICATIONS DUE TO THE CUT RATE AND LIFE OF THE PROPRIETARY NORTON BLUEFIRE GRAIN

FEATURES

BENEFITS

- | | |
|---|---|
| ■ Newest generation, patented self-sharpening zirconia alumina abrasive | ■ Aggressive cut and 30% longer life than competitive zirconia alumina |
| ■ R884P – Durable Y-weight polyester, waterproof cloth backing | ■ Long life on high-pressure, dry or wet, heavy-duty metal applications |
| ■ R823P – Strong X-weight polyester, waterproof cloth backing | ■ Moderate flexibility, dry or wet, fine grit applications |
| ■ R831 – Y-weight cotton cloth backing | ■ Durable open coat cotton belt designed for excellent stock removal on wood with limited loading |



NORTON METALITE R215 CLOTH BELTS

GOOD CHOICE FOR ABRASIVE PLANING AND DIMENSIONING OF GLUED-UP STOCK AND BANDED PARTICLEBOARD

FEATURES

BENEFITS

- | | |
|----------------------------------|--|
| ■ Strong X-weight cotton backing | ■ Aggressive cutting, resistant to heat |
| ■ Open coat design | ■ Resists loading |
| | ■ Value product for wood and soft metals |

TECHtip

- 36" wide belts can be used on machines that normally use 37" wide belts.



FastTrack Belt Service



For non-stock belts, FastTrack Service Centers offer all the benefits of an ISO 9001 quality manufacturer and the advantages of a coated abrasives express belt service. As the industry's leading producer of abrasive material and backings, our FastTrack service offers an extensive range of Norton made-to-order belts including Norton SG ceramic alumina, BlueFire zirconia alumina, and versatile aluminum oxide and silicon carbide belts.

Manufacturing lead-time is two days for narrow belts (1/2"- 12" widths) and three days for wide belts =>14" width. Please see the FastTrack Service belt section for complete availability and lead-times.

AVAILABILITY
CLOTH WIDE BELTS

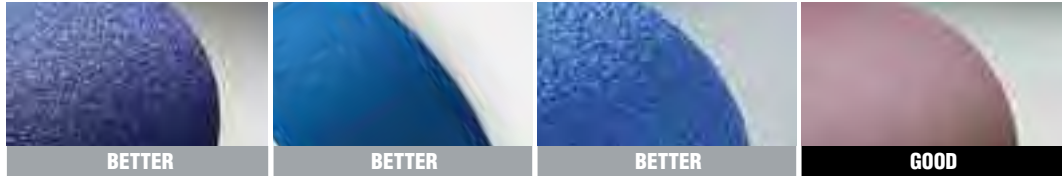

			BETTER	BETTER	BETTER	GOOD
<i>TIER:</i>			Norton	Norton	Norton	Norton
<i>BRAND:</i>			BLUEFIRE R884P	BLUEFIRE R823P	BLUEFIRE R831	METALITE R215
<i>TRADENAME::</i>			Zirconia Alumina	Zirconia Alumina	Zirconia Alumina	Aluminum Oxide
<i>ABRASIVE:</i>			Y-wt. Polyester Cloth	X-wt. Polyester Cloth	Y-wt. Polyester Cloth	X-wt. Cotton Cloth
<i>BACKING:</i>			Plyweld, RR	Plyweld, RR	Plyweld, RR	Plyweld, RR
<i>JOINT/FLEX:</i>						
SIZE (W x L)	GRIT	STD. PKG.	PART #	PART #	PART #	PART #
25 x 48	80	3		69957344781		
25 x 60	80	3		69957328117		
	120	5		69957328115		
25 x 75	120	5		69957344791		
36 x 60	120	5		69957311276		
36 x 75	36	2	69957350934			
	50	3				
	60	3	69957350931			
	80	3				
	120	5		69957329014		69957323870
37 x 60	180	5		69957344869		
	50	3	69957306219			
	80	3		69957329019		69957325709
	100	5		69957328103		69957325708
	120	5		69957329018		69957325707
	150	5		69957328102		69957302955
37 x 75	180	5		69957328101		
	220	5		69957328100		
	36	2	69957350959			69957325957
	50	3	69957305107			69957323880
	80	3	69957350955			69957325760
	100	5		69957307358		69957305737
50 x 103	120	5		69957307358		
	150	5		69957306734		
	180	5				
	36	2			69957328383	
52 x 75	60	3				
	80	3				
	120	5		69957313510		





CATEGORY DEFINITION

NORaX layered belts outlast conventional abrasive belts with 2 - 5 times longer life. Longer life, higher quality finishes, faster cut rates, and the ability to skip finishing steps all drive down the costs of your finishing processes.

- APPLICATIONS:** Polishing and finishing
- SIZE RANGE:** Stock: 1/4" to 1" wide, 12" to 30" long
- GRIT RANGE:** Stock: X200 and X100
- ABRASIVE GRAIN:** Stock: Ceramic Alumina

FEATURED PRODUCTS



NORaX U936 BELTS

BEST FOR HIGH-PRESSURE PRECISION APPLICATIONS

FEATURES

- Unique, engineered quad surface pattern
- 100% high-performance, micron-graded, cool-cutting Norton SG ceramic alumina abrasive grain
- Improved resin bond system
- Premium, Y-weight polyester waterproof backing
- Fray-resistant backing

BENEFITS

- More abrasive contact area
- Higher cut rates while maintaining more consistent finishes
- Up to more than 2X the life vs. competitive engineered ceramic belts
- Lower specific grinding energy
- Increased durability
- Durable; stands up to high-pressure, coolant applications
- Shred-free

AVAILABILITY

<i>TIER:</i>	BEST	BEST
<i>BRAND:</i>	Norton	Norton
<i>TRADENAME:</i>	NORaX U936	NORaX U936
<i>ABRASIVE:</i>	Ceramic Alumina	Ceramic Alumina
<i>BACKING:</i>	Y-wt. Polyester W/P	Y-wt. Polyester W/P
<i>JOINT/FLEX:</i>	Plyweld, TF	Plyweld, TF
<i>GRIT SIZE:</i>	X200 (80)	X100 (150)

SIZE (W x L)	STD. PKG.	PART #	PART #
1/4 x 12	50	66623300249	66623300261
1/2 x 12	50	66623300245	66623300258
1 x 12	50	66623300240	66623300255
1/4 x 18	50	66623300250	66623300262
1/2 x 18	50	66623300247	66623300259
3/4 x 18	50	66623300253	66623300264
3/4 x 20-1/2	50	66623300254	66623300265
1/4 x 24	50	66623300252	66623300263
1/2 x 24	50	66623300248	66623300260
1 x 24	50	66623300243	66623300256
1 x 30	50	66623300244	66623300257

Call your local Norton distributor or sales representative for information on additional NORaX belt sizes and specifications.

NORaX VERSUS FEPA GRADING

NORaX engineered abrasives perform over a wider range of traditional grit sequences.

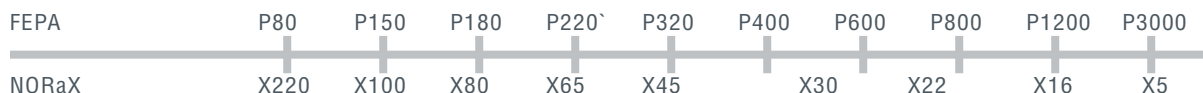



CATEGORY DEFINITION

For many non-stock belts, our FastTrack belt service centers offer all the benefits of an ISO 9001 quality manufacturer and the advantages of a coated abrasives express belt service. As the industry leader of abrasive belts, our FastTrack belt service has an extensive range of Norton made-to-order belts including Norton SG ceramic alumina, BlueFire zirconia alumina, versatile aluminum oxide, and silicon carbide belts.

Manufacturing lead-time is two days for narrow belts (1/2" – 12" wide) and three days for wide belts (14 – 52" wide). Please see the FastTrack belt service chart below for complete details on availability and lead-times.

FASTTRACK AVAILABILITY AND LEAD-TIME INFORMATION

WIDTH*	GRIT SIZE	MINIMUM ORDER QUANTITY	CASE QUANTITY	MAXIMUM ORDER QUANTITY (EQUALS 2 CASES)	CONVERSION LEAD-TIMES
Narrow Belts					
1/2" through 1"	All	50	200	400	2
Over 1" through 5"	All	10	50	100	2
Over 5" through 9"	All	10	20	40	2
Over 9" through 14"	All	10	10	20	2
Wide Belts					
Over 14" through 20"	All	5	10	20	3
Over 20" through 52"	36 & coarser	2	2	4	3
Over 20" through 52"	40-80	3	3	6	3
Over 20" through 52"	100 & finer	5	5	10	3

* FASTTRACK BELT SERVICE APPLIES TO BELTS 25" AND GREATER IN LENGTH



HOW TO PLACE A FASTTRACK BELT ORDER





- Check the FastTrack belt availability
- Include a full description of belt: quantity, size, Norton CAP code, and grit size
- Send order electronically, fax, or phone to customer service
- When ordering a belt that does not have an existing part number, please call Customer Service to expedite part number creation





BELT SPECIFICATIONS AND AVAILABILITY

TIER	PRODUCT CAP CODE	SHAPE AVAILABILITY	GRIT SIZE	ABRASIVE GRAIN	BACKING	APPLICATIONS
Metalworking						
Norton						
Best	R980P	Narrow, Wide	24-120	Norton Blaze Ceramic Alumina	Y-wt. Polyester	Latest-generation Norton SG grain, supersized and designed for high-performance grinding on stainless and other alloys
Best	R984	Narrow, Wide	36-120	Norton SG Ceramic Alumina	Y-wt. Polyester	Norton SG grain for medium-pressure grinding and finishing heat-sensitive alloys
Better	R884P	Narrow, Wide	24, 36-80	Norton BlueFire Zirconia Alumina	Y-wt. Polyester	High-performance zirconia alumina grain designed for medium- to high-pressure grinding
	R887D	Narrow, Wide	24, 36-120	Norton BlueFire Zirconia Alumina	Y-wt. Polyester	NEW! Significantly improved-performance zirconia alumina grain, supersized and designed for medium- to high-pressure grinding of heat-sensitive alloys
Better	R823P	Narrow, Wide	60-220	Norton BlueFire Zirconia Alumina	X-wt. Polyester	High-performance zirconia alumina grain on lighter backing designed for light to medium grinding
Good	R766	Narrow	P24-80	Aluminum Oxide Blend	Y-wt. Polyester	Premium aluminum oxide blend product designed for a variety of applications including soft metals to hard-to-grind stainless and carbon steel
	R766X	Narrow, Wide	P60-P400	Norton Neon Aluminum Oxide	X-wt. Polyester	NEW! Quality, P-graded aluminum oxide and broad grit range for stock removal to finer finishing
Good	MX240	Narrow, Wide	P60-P150	Aluminum Oxide	X-wt. Poly/Cotton	P-graded, heat-treated aluminum oxide X-weight cloth with strong, but flexible, cotton/ polyester backing making it an ideal multi-purpose product
Good	R245	Narrow	P80-P240, P320, P400	Aluminum Oxide	J-wt. Polyester	Aluminum oxide on flexible, lightweight polyester backing for moderate- to light- pressure applications on mild steel
Good	KF376	Narrow	P80-P320, P400, P600	Aluminum Oxide	J-wt. Cotton	P-graded, heat-treated aluminum oxide with ceramic coating on a very flexible backing for use wherever flexibility and conformability are needed
Good	R445	Narrow	60-220	Silicon Carbide	X-wt. Polyester	Sharp, silicon carbide grain on medium polyester backing for grinding very hard materials – glass, stone, solid surface
Good	U243	Narrow, Wide to 12"	X80, X65, X45, X30, X22, X16	NORaX Aluminum Oxide	J-wt. Cotton	High-performance, multi-layered NORaX grain on very flexible backing for dry polishing applications

TIER	PRODUCT CAP CODE	SHAPE AVAILABILITY	GRIT SIZE	ABRASIVE GRAIN	BACKING	APPLICATIONS
Woodworking						
Norton						
Best	R963	Narrow, Wide	24-60, P80 100-150	Norton SG Ceramic Alumina	Y-wt. Polyester	Norton SG ceramic alumina grain with anti-static coating for forest product applications (MDF, particleboard, plywood)
Best	R955	Narrow	P36-P120	Norton Red Heat Ceramic Alumina	Y-wt. Cotton	100% ceramic alumina abrasive with Y-weight cloth backing for dimensioning, intermediate sanding of wood
Better	R831	Narrow, Wide	24, 36-120	Norton BlueFire Zirconia Alumina	Y-wt. Cotton	Norton BlueFire open-coat product recommended for dry low-pressure applications or where loading is a problem
Good	R215	Narrow, Wide	50-180	Aluminum Oxide	X-wt. Cotton	Initial starting specification for all woodworking applications where loading is a problem
Good	R490	Narrow, Wide	P36-P150	Silicon Carbide	Y-wt. Polyester	Anti-static product for forest product applications (MDF, particle board, plywood) where loading is an issue
Good	R422	Narrow	50-120	Silicon Carbide	X-wt. Cotton	Initial starting specification for all woodworking applications where loading is not an issue
	H975	Narrow, Wide	60-220	Norton Red Heat Ceramic Alumina	F-wt. Paper	NEW! Ceramic alumina grain, antistatic coating, and open coat; the best choice for applications where loading is a problem (soft woods, etc.)
	H831	Narrow, Wide	24,36-120	Norton BlueFire Zirconia Alumina	F-wt. Paper	NEW! Durable zirconia alumina grain, antistatic coating, and open coat: the better choice for applications where loading is a problem (soft woods, etc.)
	H275B	Narrow, Wide	P60-P220	Norton Adalox Aluminum Oxide	F-wt. Paper	NEW! Quality aluminum oxide grain, antistatic coating, and open coat make these an economical choice for all heavy-weight paper belt jobs
	H475	Narrow, Wide	P120-P400	Norton Onyx Silicon Carbide	F-wt. Paper	NEW! Sharp silicon carbide and antistatic coating create finer finishes on hard materials and veneers where finish is critical



CATEGORY DEFINITION

Flap wheels are an ideal choice for a wide variety of blending, deburring and finishing applications common in the metal fabrication, welding and polishing industries. Flap wheels are conformable to intricate shapes and contours. Designed to deliver a consistent finish with a uniform rate of cut, flap wheels wear away, continually exposing fresh abrasives.

- APPLICATIONS:** Used for a wide range of metal fabrication and welding applications including stock removal, blending, deburring, cleaning, finishing, and polishing
- SIZE RANGE:** Flap wheels with mounted steel shanks: 3/8" - 3" diameter
Flap wheels with mounted 1/4"-20 thread: 1" - 3" diameter
Flap wheels with arbor holes: 3-1/2" - 16" diameter
- GRIT RANGE:** 40 - 320
- ABRASIVE GRAIN:** Ceramic Alumina/Aluminum Oxide Blend, Aluminum Oxide

SHAPE RECOMMENDATION GUIDE

SHAPE

DESCRIPTION/APPLICATION

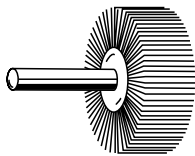

Flap Wheels with Mounted Steel Shanks

Wheels are designed with a 1/8" or 1/4" steel shank as an integral part of each wheel. These shanks run through the wheel creating better balance, a reduction of chatter, and reduced operator fatigue. They also permit quick changes on air tools when using other abrasive products.



Flap Wheels with Mounted 1/4-20 Thread

Wheels are designed with a 1/4"-20 thread and flange as an integral part of the wheel. These threads facilitate the quickest changes on air tools using flap wheels exclusively, as there are no special tools needed to change the flap wheel. Also allow extended reach with accessory mandrels.



Flap Wheels with Arbor Holes

For use on larger portable and fixed-base tools where the wheel must fit on an existing arbor.

APPLICATION/GRIT RECOMMENDATION GUIDE

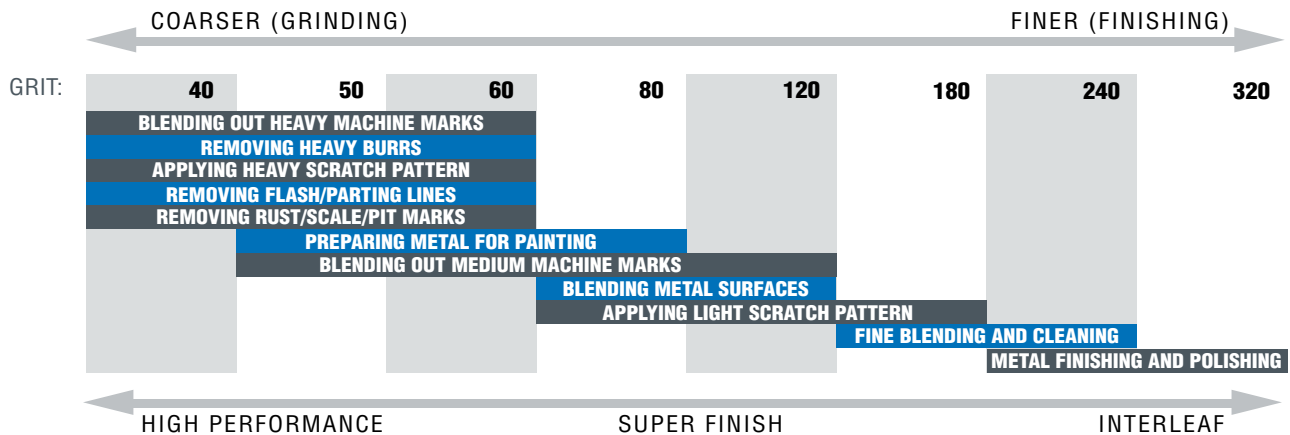

SEE NON-WOVEN FLAP WHEEL SECTION FOR INTERLEAF FLAP WHEELS



FEATURED PRODUCTS



MERIT HIGH PERFORMANCE

GOOD CHOICE FOR MORE DURABLE FLAP WHEEL APPLICATIONS WHERE AGGRESSIVE CUT AND SUPERIOR LIFE ARE REQUIRED

FEATURES

- Long-lasting ceramic alumina/aluminum oxide abrasive grain blend
- Heavy cotton backing

BENEFITS

- Aggressive cut and 2 to 3 times longer life
- Extended durability for added life and reduced edge wear



MERIT SUPER FINISH

GOOD CHOICE WHERE SUPERIOR FINISH IS REQUIRED, OR ON LOW-PRESSURE APPLICATIONS

FEATURES

- Long-lasting premium aluminum oxide abrasive blend
- Premium flexible cotton backing

BENEFITS

- Excellent cut rate on low-pressure finishing operations
- Softer acting with more flexibility for improved finishing



MERIT METAL

GOOD CHOICE WHEN INITIAL PRICE IS THE MAIN CONSIDERATION

FEATURES

- Quality aluminum oxide abrasive
- Engineered, low-cost cotton backing
- Competitive initial price point

BENEFITS

- Good cut rate and life
- Longer life and wear resistance
- Best starting specification for end-user unable to measure total performance





Micro-Mini Flap Wheels with 1/8" Mounted Steel Shanks

- The smallest flap wheels, ranging from 3/8" to 1-3/16" diameter, mounted on a 1/8" diameter steel shank
- Provide fast polishing and light deburring of internal workpieces with holes or grooves as small as 1/2"

AVAILABILITY

TIER:	GOOD
BRAND:	Merit
TRADENAME:	MICRO-MINI
ABRASIVE:	Aluminum Oxide

TIER:	GOOD
BRAND:	Merit
TRADENAME:	MICRO-MINI
ABRASIVE:	Aluminum Oxide

SIZE (D x W x SK.)	GRIT	MAX. RPM	STD. PKG.	PART #	
3/8 x 3/8 x 1/8	60	40,000	10	08834137470	
	80	40,000	10	08834137471	
	120	40,000	10	08834137472	
	180	40,000	10	08834137473	
	240	40,000	10	08834137474	
5/8 x 5/8 x 1/8	320	40,000	10	08834137475	
	5/8 x 5/8 x 1/8	60	37,000	10	08834137480
		80	37,000	10	08834137481
		120	37,000	10	08834137482
		180	37,000	10	08834137483
240		37,000	10	08834137484	
5/8 x 3/4 x 1/8	320	37,000	10	08834137485	
	80	37,000	10	08834137541	
	120	37,000	10	08834137542	
	180	37,000	10	08834137543	
	240	37,000	10	08834137544	
3/4 x 3/16 x 1/8	320	37,000	10	08834137545	
	60	35,000	10	08834137550	
	80	35,000	10	08834137551	
	120	35,000	10	08834137552	
	180	35,000	10	08834137553	
3/4 x 3/8 x 1/8	240	35,000	10	08834137554	
	320	35,000	10	08834137555	
	60	35,000	10	08834137560	
	80	35,000	10	08834137561	
	120	35,000	10	08834137562	
3/4 x 1/2 x 1/8	180	35,000	10	08834137563	
	240	35,000	10	08834137564	
	320	35,000	10	08834137565	
	60	35,000	10	08834137570	
	80	35,000	10	08834137571	
	120	35,000	10	08834137572	
	180	35,000	10	08834137573	
	240	35,000	10	08834137574	
	320	35,000	10	08834137575	

SIZE (D x W x SK.)	GRIT	MAX. RPM	STD. PKG.	PART #
3/4 x 5/8 x 1/8	60	35,000	10	08834137580
	80	35,000	10	08834137581
	120	35,000	10	08834137582
	180	35,000	10	08834137583
	240	35,000	10	08834137584
3/4 x 3/4 x 1/8	320	35,000	10	08834137585
	60	35,000	10	08834137590
	80	35,000	10	08834137591
	120	35,000	10	08834137592
	180	35,000	10	08834137593
1-3/16 x 1/8 x 1/8	240	35,000	10	08834137594
	320	35,000	10	08834137595
	80	30,000	10	08834137491
	120	35,000	10	08834137492
	180	35,000	10	08834137493
1-3/16 x 3/16 x 1/8	240	35,000	10	08834137494
	320	35,000	10	08834137495
	60	30,000	10	08834137508
	80	35,000	10	08834137501
	120	35,000	10	08834137502
1-3/16 x 3/8 x 1/8	180	35,000	10	08834137503
	240	35,000	10	08834137504
	320	35,000	10	08834137505
	80	30,000	10	08834137511
	120	35,000	10	08834137512
	180	35,000	10	08834137513
	240	35,000	10	08834137514
	320	35,000	10	08834137515

SOME MERIT PART NUMBERS ARE NON-STOCK. ASK YOUR NORTON/MERIT REPRESENTATIVE FOR STOCK/MTO STATUS.



Flap Wheel Test Kits

Micro-Mini Test Kit "MMC"

- Part # 08834131493
- Includes five wheels, 3/8" to 1-3/16" diameter in various grits, mounted on a 1/8" diameter hardened steel shank
- The "MMC" kit is ideal for fast polishing and light deburring of internal holes or grooves as small as 1/2"



Shank-Mounted Mini Test Kit "CMM"

- Part # 08834138004
- Includes ten wheels, 1" to 3" diameter in various grits mounted on a 1/4" diameter hardened steel shank

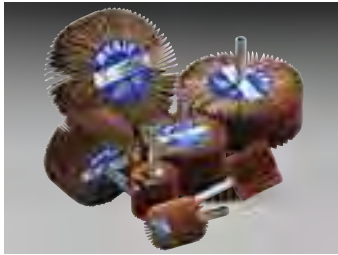

Mini Flap Wheels with 1/4" Mounted Steel Shanks

- Small flap wheels, ranging from 1" to 3" diameter, mounted on a 1/4" diameter steel shank
- Very durable, long-lasting mini flap wheels for demanding, heavy stock removal applications

AVAILABILITY



TIER: **GOOD**
 BRAND: Merit
 TRADENAME: **HIGH PERFORMANCE**
 ABRASIVE: Ceramic Alumina/
 Aluminum Oxide Blend

SIZE (D x W x SK.)	GRIT	MAX. RPM	STD. PKG.	PART #	PART #	PART #
1 x 1/2 x 1/4	60	30,000	10			08834149800
	80	30,000	10			08834149801
	120	30,000	10			08834149802
1 x 5/8 x 1/4	40	30,000	10	08834137105		
	60	30,000	10	08834137100	08834130754	
	80	30,000	10	08834137101	08834130755	
	120	30,000	10	08834137102	08834130756	
	180	30,000	10	08834131536	08834130757	
	240	30,000	10	08834137104	08834130758	
	320	30,000	10	08834137357	08834130759	
1 x 1 x 1/4	40	30,000	10	08834131259		08834149803
	50	30,000	10	08834137309		
	60	30,000	10	08834137310	08834130760	08834149804
	80	30,000	10	08834137311	08834130761	08834149805
	120	30,000	10	08834137312	08834130762	08834149806
	180	30,000	10	08834137313	08834130763	08834149807
	240	30,000	10	08834137114	08834130764	08834149808
1-3/16 x 1/4 x 1/4	60	25,000	10	08834137315	08834130765	08834149809
	80	25,000	10		08834137600	
	120	25,000	10		08834137601	
1-3/16 x 1/2 x 1/4	60	25,000	10		08834137602	
	80	25,000	10		08834137810	
	120	25,000	10		08834137811	
1-3/8 x 5/8 x 1/4	60	30,000	10	08834137320		
	80	30,000	10	08834137321		
	120	30,000	10	08834137322		
	180	30,000	10	08834137323		
	240	30,000	10	08834137324		
1-1/2 x 1/2 x 1/4	60	25,000	10		08834137130	08834149810
	80	25,000	10		08834137131	08834149811
	120	25,000	10		08834137132	08834149812
	180	25,000	10		08834137133	
	240	25,000	10		08834137134	
1-1/2 x 1 x 1/4	40	25,000	10	08834135140		
	60	25,000	10	08834137340	08834130766	08834149816
	80	25,000	10	08834137141	08834130767	08834149817
	120	25,000	10	08834137142	08834130768	08834149818
	180	25,000	10	08834137343	08834130769	08834149819
	240	25,000	10	08834132101	08834130770	
	320	25,000	10	08834137145	08834130771	
1-1/2 x 1-1/2 x 1/4	40	25,000	10	08834130642		
	60	25,000	10	08834130643		
	80	25,000	10	08834130644		
	120	25,000	10	08834130641		
	180	25,000	10	08834130695		
2 x 1/2 x 1/4	40	25,000	10			08834149820
	60	25,000	10		08834137350	08834149821
	80	25,000	10		08834137151	08834149822
	120	25,000	10		08834137152	08834149823
	180	25,000	10		08834137353	
	240	25,000	10		08834137354	
	320	25,000	10		08834137355	



Mini Flap Wheels with 1/4" Mounted Steel Shanks CONTINUED

AVAILABILITY

TIER:
 BRAND:
 TRADENAME:
 ABRASIVE:

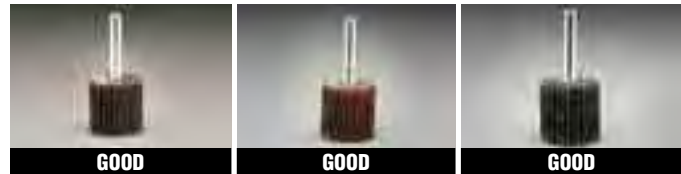

GOOD	GOOD	GOOD
Merit	Merit	Merit
HIGH PERFORMANCE	SUPER FINISH	METAL
Ceramic Alumina/ Aluminum Oxide Blend	Aluminum Oxide	Aluminum Oxide

SIZE (D x W x SK.)	GRIT	MAX. RPM	STD. PKG.	PART #	PART #	PART #
2 x 3/4 x 1/4	40	25,000	10	08834137158		
	60	25,000	10	08834137160	08834130772	
	80	25,000	10	08834137161	08834130773	
	120	25,000	10	08834137162	08834130774	
	180	25,000	10	08834137163	08834130775	
2 x 1 x 1/4	40	25,000	10	08834137377		08834149824
	50	25,000	10	08834137169		
	60	25,000	10	08834137370	08834130778	08834149825
	80	25,000	10	08834137371	08834130779	08834149826
	120	25,000	10	08834137372	08834130780	08834149827
	180	25,000	10	08834137373	08834130781	08834149828
	240	25,000	10	08834137374	08834130782	
	320	25,000	10	08834137375	08834130783	
2 x 1-1/2 x 1/4	40	25,000	10	08834137183		
	60	25,000	10	08834137380	08834130784	
	80	25,000	10	08834137381	08834130785	
	120	25,000	10	08834137382	08834130786	
	180	25,000	10	08834137383		
	240	25,000	10	08834137384		
	320	25,000	10	08834137319		
2-1/2 x 1 x 1/4	40	20,000	10	08834137408		
	60	20,000	10	08834137410	08834130790	
	80	20,000	10	08834137411	08834130791	
	120	20,000	10	08834137412	08834130792	
	180	20,000	10	08834137413	08834130793	
	240	20,000	10	08834137633	08834130794	
	320	20,000	10	08834137415	08834130795	
2-1/2 x 1-1/2 x 1/4	60	20,000	10	08834137420		
	80	20,000	10	08834137421		
	120	20,000	10	08834137422		
3 x 1/2 x 1/4	40	20,000	10			08834149833
	60	20,000	10		08834137230	08834149834
	80	20,000	10		08834137231	08834149835
	120	20,000	10		08834131610	
	180	20,000	10		08834137433	
	240	20,000	10		08834137235	
	320	20,000	10		08834137287	
3 x 3/4 x 1/4	60	20,000	10	08834137440	08834130796	
	80	20,000	10	08834137441	08834130797	
	120	20,000	10		08834130798	
3 x 1 x 1/4	40	20,000	10	08834137456		08834149836
	60	20,000	10	08834137450	08834130802	08834149837
	80	20,000	10	08834137451	08834130803	08834149838
	120	20,000	10	08834137252	08834130804	08834149839
	180	20,000	10	08834137253	08834130805	08834149840
	240	20,000	10	08834135339	08834130806	
	320	20,000	10	08834135341	08834130807	
3 x 2 x 1/4	40	12,000	10	08834137460		
	60	12,000	10	08834137260		
	80	12,000	10	08834137261		
	120	12,000	10	08834137262		
	180	12,000	10	08834137263		
3 x 2 x 3/8	60	12,000	10	08834135050		
	80	12,000	10	08834135051		
	120	12,000	10	08834135052		

SOME FLAP WHEEL PART NUMBERS ARE NON-STOCK. ASK YOUR NORTON/MERIT REPRESENTATIVE FOR STOCK/MTO STATUS.



Mini Flap Wheels with 1/4"-20 Thread

- Mini flap wheels ranging from 1" to 3" diameter, mounted on a 14-20 thread that allows you to quickly spin the wheels on and off with no tools
- Designed for polishing and finishing intricate surfaces; cost-effective replacement for brushes, rubber points, and felt bobs

AVAILABILITY



TIER:	GOOD	GOOD
BRAND:	Merit	Merit
TRADENAME:	HIGH PERFORMANCE	SUPER FINISH
ABRASIVE:	Ceramic Alumina/ Aluminum Oxide Blend	Aluminum Oxide

SIZE (D x W x THD.)	GRIT	MAX. RPM	STD. PKG.	PART #	PART #
1 x 5/8 x 1/4-20	60	30,000	10	08834131001	08834130814
	80	30,000	10	08834131002	08834130701
	120	30,000	10	08834131003	08834130702
	180	30,000	10		08834130703
1 x 1 x 1/4-20	40	30,000	10	08834131027	
	60	30,000	10	08834131008	08834130706
	80	30,000	10	08834131009	08834130707
	120	30,000	10	08834131010	08834130708
	180	30,000	10	08834131011	08834130709
	240	30,000	10	08834131012	08834130710
1-3/8 x 5/8 x 1/4-20	60	30,000	10	08834132001	
	80	30,000	10	08834132002	08834130834
	120	30,000	10	08834132003	
1-5/8 x 1/2 x 1/4-20	60	25,000	10		08834132008
	80	25,000	10		08834132009
	120	25,000	10		08834132010
	180	25,000	10		08834132011
1-5/8 x 1 x 1/4-20	40	25,000	10	08834132051	
	60	25,000	10	08834132015	08834130712
	80	25,000	10	08834132016	08834130713
	120	25,000	10	08834132017	08834130714
	180	25,000	10	08834132018	08834130715
	320	25,000	10	08834132020	
2 x 1/2 x 1/4-20	60	25,000	10		08834133001
	80	25,000	10		08834133002
	120	25,000	10		08834133003
	180	25,000	10		08834133004
	320	25,000	10		08834133006
2 x 3/4 x 1/4-20	60	25,000	10	08834133008	08834130718
	80	25,000	10	08834133009	08834130719
	120	25,000	10	08834133010	08834130720
	180	25,000	10	08834133011	
2 x 1 x 1/4-20	40	25,000	10	08834133044	
	60	25,000	10	08834133015	08834130724
	80	25,000	10	08834133016	08834130725
	120	25,000	10	08834133017	08834130726
	180	25,000	10	08834133018	08834130727
	240	25,000	10	08834133019	08834130728
	320	25,000	10	08834133020	08834130729
2 x 1-1/2 x 1/4-20	60	25,000	10	08834135201	08834130730
	80	25,000	10	08834135202	08834130731
	120	25,000	10	08834135203	08834130732
	180	25,000	10	08834135204	
2-1/2 x 1/4 x 1/4-20	60	20,000	10		08834134001
	80	20,000	10		08834134002
	120	20,000	10		08834134003
	180	20,000	10		08834134004
	240	20,000	10		08834134005
2-1/2 x 3/8 x 1/4-20	60	20,000	10		08834134008
	80	20,000	10		08834134009
	120	20,000	10		08834134010
2-1/2 x 1/2 x 1/4-20	60	20,000	10		08834134015
	80	20,000	10		08834134016
	120	20,000	10		08834134017
	180	20,000	10		08834134018

FOR ADAPTERS FOR FLAP WHEELS WITH 1/4"-20 THREAD, SEE THE END OF THIS SECTION

CONTINUED

SOME FLAP WHEEL PART NUMBERS ARE NON-STOCK. ASK YOUR NORTON/MERIT REPRESENTATIVE FOR STOCK/MTO STATUS.



Mini Flap Wheels with 1/4"-20 Thread CONTINUED

AVAILABILITY

TIER:	GOOD	GOOD
BRAND:	Merit	Merit
TRADENAME:	HIGH PERFORMANCE	SUPER FINISH
ABRASIVE:	Ceramic Alumina/ Aluminum Oxide Blend	Aluminum Oxide



SIZE (D x W x THD.)	GRIT	MAX. RPM	STD. PKG.	PART #	PART #
2-1/2 x 1 x 1/4-20	40	20,000	10	08834134061	
	60	20,000	10	08834134022	08834130736
	80	20,000	10	08834134023	08834130737
	120	20,000	10	08834134024	08834130738
	180	20,000	10	08834134025	
3 x 1/2 x 1/4-20	60	20,000	10		08834135001
	80	20,000	10		08834135002
	120	20,000	10		08834135003
	180	20,000	10		08834135004
3 x 3/4 x 1/4-20	60	20,000	10	08834135008	08834130742
	80	20,000	10	08834135009	
	120	20,000	10	08834135010	08834130744
3 x 1 x 1/4-20	40	20,000	10	08834135230	
	60	20,000	10	08834135015	08834130748
	80	20,000	10	08834135016	08834130749
	120	20,000	10	08834135017	08834130750
	180	20,000	10	08834135018	08834130751
	240	20,000	10	08834135019	08834130752
	320	20,000	10		08834130753

FOR ADAPTERS FOR FLAP WHEELS WITH 1/4"-20 THREAD, SEE THE END OF THIS SECTION
SOME FLAP WHEEL PART NUMBERS ARE NON-STOCK. ASK YOUR NORTON/MERIT REPRESENTATIVE FOR STOCK/MTO STATUS.



Cup-Type Mini Flap Wheels with 1/4" Mounted Steel Shanks

- Primarily used for bottom or side-wall type sanding where conventional tools do not reach
- Cup-type mini flap wheels will not mar your workpiece while reaching flush into areas where other wheels cannot reach

AVAILABILITY

TIER:	GOOD
BRAND:	Merit
ABRASIVE:	Aluminum Oxide

D x W x SK.	MAX. RPM	GRIT	STD. PKG.	PART #
2-1/2 x 1-1/2 x 1/4	20,000	60	10	08834144463

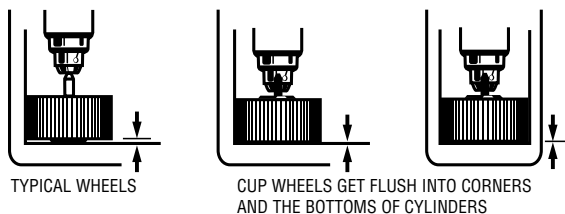

Flap Wheel Test Kits

Merit Mini 1/4"-20 Thread Test Kit "CQ"

- Part # 08834138001
- Includes ten, 1" to 3" diameter, 1/4"-20 thread mini flap wheels
- Each kit includes a 1/4"-20 QC-4 quick-change adapter

Merit Mini Grind-O-Flex Test Kit "CMM"

- Part # 08834138004
- Includes ten wheels, 1" to 3" diameter in various grits
- Each wheel comes with a 1/4" steel mandrel permanently mounted

Merit Micro Mini GOF Test Kit "MMC"

- Part # 08834131493
- Includes 5 wheels, 3/8" to 1-3/16" in diameter
- The flap wheels are mounted on a 1/8" diameter hardened steel shank
- Ideal for fast polishing and light deburring of holes or grooves



3-1/2" – 8" Flap Wheels with Arbor Holes

- Flap wheels ranging from 3-12" to 8" diameter with arbor holes
- Heavy cotton backing and premium abrasive grains combine to provide superior life with aggressive cut on a wide range of polishing and finishing applications



AVAILABILITY

TIER:	GOOD
BRAND:	Merit
TRADENAME:	HIGH PERFORMANCE
ABRASIVE:	Ceramic Alumina/ Aluminum Oxide Blend

SIZE (D x W x H)	GRIT	MAX. RPM	STD. PKG.	PART #
3-1/2 x 1 x 5/8	40	12,000	10	08834122001
	50	12,000	10	08834122002
	60	12,000	10	08834122003
	80	12,000	10	08834122004
	120	12,000	10	08834122006
	180	12,000	10	08834122007
	240	12,000	10	08834122008
3-1/2 x 1-1/2 x 5/8	320	12,000	10	08834122009
	40	12,000	10	08834122011
	50	12,000	10	08834122012
	60	12,000	10	08834122013
	80	12,000	10	08834122014
	120	12,000	10	08834122016
	150	12,000	10	08834122017
3-1/2 x 2 x 5/8	180	12,000	10	08834122018
	320	12,000	10	08834122020
	40	12,000	10	08834122022
	60	12,000	10	08834122024
	80	12,000	10	08834122025
4 x 1 x 5/8	120	12,000	10	08834122027
	180	12,000	10	08834122028
	40	12,000	10	08834122032
	50	12,000	10	08834122033
	60	12,000	10	08834122034
	80	12,000	10	08834122035
	120	12,000	10	08834122037
4 x 1-1/2 x 5/8	180	12,000	10	08834122038
	240	12,000	10	08834122039
	320	12,000	10	08834122040
	40	12,000	10	08834122042
	50	12,000	10	08834122043
	60	12,000	10	08834122044
	80	12,000	10	08834122045
4 x 2 x 5/8	120	12,000	10	08834122047
	240	12,000	10	08834122050
	40	12,000	10	08834122053
	50	12,000	10	08834122054
	60	12,000	10	08834122055
	80	12,000	10	08834122056
	120	12,000	10	08834122058
5 x 1-1/2 x 5/8	180	12,000	10	08834122059
	240	12,000	10	08834122060
	320	12,000	10	08834122061
	40	12,000	10	08834122063
	50	12,000	10	08834122064
	60	12,000	10	08834122065
	80	12,000	10	08834122066
5 x 2 x 5/8	120	12,000	10	08834122068
	180	12,000	10	08834122070
	240	12,000	10	08834122071
	320	12,000	10	08834122072

FOR FLAP WHEEL WITH ARBOR HOLE ADAPTERS AND BUSHINGS, SEE THE END OF THIS SECTION
 A SET OF REDUCING BUSHING WILL BE INCLUDED FOR 1" CENTER HOLE WHEELS AT NO CHARGE WHEN PURCHASED WITH FLAP WHEELS AND SPECIFIED ON THE ORDER. REFER TO REDUCING BUSHING FOR ADDITIONAL INFORMATION.
 SOME FLAP WHEEL PART NUMBERS ARE NON-STOCK. ASK YOUR NORTON/MERIT REPRESENTATIVE FOR STOCK/MTO STATUS.

CONTINUED



3-1/2" – 8" Flap Wheels with Arbor Holes CONTINUED

AVAILABILITY



TIER:	GOOD	GOOD	GOOD
BRAND:	Merit	Merit	Merit
TRADENAME:	HIGH PERFORMANCE	SUPER FINISH	METAL
ABRASIVE:	Ceramic Alumina/ Aluminum Oxide Blend	Aluminum Oxide	Aluminum Oxide

SIZE (D x W x H)	GRIT	MAX. RPM	STD. PKG.	PART #	PART #	PART #
6 x 1/2 x 1	40	6,000	10	08834123001		
	60	6,000	10	08834123003		
	80	6,000	10	08834123004		
	120	6,000	10	08834123005		
	150	6,000	10	08834122198		
	180	6,000	10	08834123006		
	240	6,000	10	08834123007		
	320	6,000	10	08834122137		
6 x 1 x 1	40	6,000	5	08834123009		08834120167
	50	6,000	5	08834123010		08834120168
	60	6,000	5	08834123011	08834121002	08834120169
	80	6,000	5	08834123012	08834121003	08834120170
	100	6,000	5			08834120171
	120	6,000	5	08834123014	08834121005	08834120172
	150	6,000	5	08834123015	08834121006	
	180	6,000	5	08834123016	08834121007	08834120174
	240	6,000	5	08834123017	08834121008	08834120176
	320	6,000	5	08834123018	08834121009	08834120177
6 x 1-1/2 x 1	40	6,000	5	08834123020		
	50	6,000	5	08834123021		
	60	6,000	5	08834123022	08834121023	
	80	6,000	5	08834123023	08834121024	
	120	6,000	5	08834123025	08834121025	
	150	6,000	5	08834123026	08834121106	
	180	6,000	5	08834123027	08834121026	
	240	6,000	5	08834123028		
	320	6,000	5	08834123029	08834121109	
	6 x 2 x 1	40	6,000	5	08834123031	
50		6,000	5	08834123032		
60		6,000	5	08834123033	08834121030	08834120191
80		6,000	5	08834123034	08834121031	08834120192
100		6,000	5			08834120198
120		6,000	5	08834123036	08834121032	08834120194
180		6,000	5	08834123038	08834121033	08834120197
240		6,000	5	08834123039	08834121034	08834120199
320		6,000	5	08834123040	08834121035	08834120493
6 x 3 x 1		40	6,000	3	08834123053	
	50	6,000	3	08834123054		
	60	6,000	3	08834123055		
	80	6,000	3	08834123056		
	120	6,000	3	08834123058		
	150	6,000	3	08834122544		
	180	6,000	3	08834123060		
	240	6,000	3	08834123061		
	320	6,000	3	08834122329		
	8 x 1 x 1	40	4,500	3	08834123070	
50		4,500	3	08834123071		
60		4,500	3	08834123072		
80		4,500	3	08834123073		
120		4,500	3	08834123075		
180		4,500	3	08834123077		
240		4,500	3	08834123078		
320		4,500	3	08834123079		
8 x 2 x 1	40	4,500	3	08834123092		
	50	4,500	3	08834123093		
	60	4,500	3	08834123094		
	80	4,500	3	08834123095		
	120	4,500	3	08834123097		
	180	4,500	3	08834123099		
	240	4,500	3	08834123100		
	320	4,500	3	08834123101		

FOR FLAP WHEEL WITH ARBOR HOLE ADAPTERS AND BUSHINGS, SEE THE END OF THIS SECTION
 A SET OF REDUCING BUSHING WILL BE INCLUDED FOR 1" CENTER HOLE WHEELS AT NO CHARGE WHEN PURCHASED WITH FLAP WHEELS AND SPECIFIED ON THE ORDER. REFER TO REDUCING BUSHING FOR ADDITIONAL INFORMATION.



10" – 16" Large Flap Wheels with Arbor Holes

Wide range of applications:

- For polishing/grinding jobs in production work as well as clean-up and maintenance jobs
- Work on metals, plastic, rubber and wood

Easy to operate:

- No adjustments, dressing, or preparation required before or during operation

Fewer rejected parts:

- More forgiving than other abrasive products
- Reduce the possibility of flattening, gouging and surface deformation

AVAILABILITY

TIER:	GOOD
BRAND:	Merit
TRADENAME:	HIGH PERFORMANCE
ABRASIVE:	Ceramic Alumina/ Aluminum Oxide Blend

SIZE (D x W x H)	GRIT	MAX. RPM	STD. PKG.	PART #
10 x 1 x 1-3/4	40	4,000	4	08834122223
	60	4,000	4	08834124002
	80	4,000	4	08834124003
	120	4,000	4	08834124005
	150	4,000	4	08834124006
	180	4,000	4	08834124007
	320	4,000	4	08834122889
10 x 1-1/2 x 1-3/4	60	4,000	4	08834124022
	80	4,000	4	08834124023
	120	4,000	4	08834124025
	180	4,000	4	08834124027
10 x 2 x 1-3/4	60	4,000	2	08834124042
	80	4,000	2	08834124043
	120	4,000	2	08834124045
	180	4,000	2	08834124047
10 x 3 x 1-3/4	60	4,000	2	08834124077
	80	4,000	2	08834122316
	120	4,000	2	08834122131
	180	4,000	2	08834122132
12 x 1 x 1-3/4	60	3,000	4	08834124085
	80	3,000	4	08834122349
	120	3,000	4	08834122311
	180	3,000	4	08834122315
12 x 2 x 1-3/4	40	3,000	2	08834122248
	50	3,000	2	08834122249
	60	3,000	2	08834122250
	80	3,000	2	08834122267
	120	3,000	2	08834122269
	150	3,000	2	08834122270
	180	3,000	2	08834122271
	240	3,000	2	08834122273
320	3,000	2	08834122275	
12 x 4 x 1-3/4	50	2,400	1	08834120013
	80	2,400	1	08834120015
	120	2,400	1	08834120016
	180	2,400	1	08834120017
	240	2,400	1	08834120019
14 x 1 x 1-3/4	60	2,400	1	08834120020
	120	2,400	1	08834120022
14 x 1-1/2 x 1-3/4	60	2,400	1	08834120024
	80	2,400	1	08834120025
	120	2,400	1	08834120026
	180	2,400	1	08834120027

AVAILABILITY

TIER:	GOOD
BRAND:	Merit
TRADENAME:	HIGH PERFORMANCE
ABRASIVE:	Ceramic Alumina/ Aluminum Oxide Blend

SIZE (D x W x H)	GRIT	MAX. RPM	STD. PKG.	PART #
14 x 2 x 1-3/4	60	2,400	1	08834120028
	80	2,400	1	08834123215
	120	2,400	1	08834122907
	240	2,400	1	08834120032
14 x 3 x 1-3/4	60	2,400	1	08834120033
	80	2,400	1	08834120034
	120	2,400	1	08834120035
14 x 4 x 1-3/4	240	2,400	1	08834120036
	60	2,000	1	08834120037
	80	2,000	1	08834122829
16 x 1 x 1-3/4	120	2,000	1	08834122502
	240	2,000	1	08834120041
	60	2,400	1	08834120042
	80	2,400	1	08834120043
16 x 1 x 1-3/4	120	2,400	1	08834120044
	180	2,400	1	08834120045
	240	2,400	1	08834120046
	60	2,400	1	08834120047
16 x 2 x 1-3/4	80	2,400	1	08834120049
	120	2,400	1	08834120050
	180	2,400	1	08834120051
	240	2,400	1	08834120052
16 x 3 x 1-3/4	60	2,400	1	08834120053
	80	2,400	1	08834120054
	120	2,400	1	08834120055
	180	2,400	1	08834120056
16 x 4 x 1-3/4	240	2,400	1	08834120057
	60	2,000	1	08834120058
	120	2,000	1	08834120060
	240	2,000	1	08834122435
16 x 6 x 1-3/4	80	2,000	1	08834120068
	120	2,000	1	08834120069
	180	2,000	1	08834120070
	240	2,000	1	08834120071

FOR FLAP WHEEL WITH ARBOR HOLE ADAPTERS AND BUSHINGS, SEE THE END OF THIS SECTION FOR ADDITIONAL INFORMATION.

SOME FLAP WHEEL PART NUMBERS ARE NON-STOCK. ASK YOUR NORTON/MERIT REPRESENTATIVE FOR STOCK/MTO STATUS.



Adapter and Bushings for Flap Wheels with Arbor Holes

WHEEL DIAMETER	ADAPTERS	PART #
Shank Adapters		
3-1/2	1/4 Shank	08834125001
3-1/2	3/8 Shank	08834125007
4-8	1/4 Shank	08834125003
Threaded Mounting Adapters		
4-8	5/8-11 Thread	08834125027
Reducing Bushings		
6-8	1 to 3/8	08834125016
	1 to 1/2	08834125017
	1 to 5/8	08834125018
	1 to 3/4	08834125019
	1 to 7/8	08834125020
10-16	1 to 5/8	08834122069

STANDARD PACKAGES = 1 ADAPTER, 1 PAIR OF BUSHINGS
 FOR ADDITIONAL ALUMINUM REDUCING BUSHINGS SEE NON-WOVEN CONVOLUTE WHEEL SECTION PAGE 198



08834125001



08834125007



08834125003



08834125027



08834125016

Adapters for 1/4"-20 Thread Mini and Arbor Hole Flap Wheels

MODEL #	DESCRIPTION	PART #
Adapters		
ADAPT C	Fits 3 x 2 x 3/8 arbor flap wheel	08834137009
MA-100	Fits A.H. Mini Wheel	08834137007
QC-8	1/8 x 5/8	08834137002
QC-4	1/4 SK. Dia. x 5/8 SK. L.	08834137001
QC-44	1/4 x 4	08834137003
QC-46	1/4 x 6	08834137004
QC-48	1/4 x 8	08834137005
QC-T	1/4-20 Thread	08834137012
QC-T	3/8-24 Thread	08834137010

STANDARD PACKAGE = 1 ADAPTER
 OTHER THREAD SIZES AVAILABLE FOR QUOTATION



QC-4

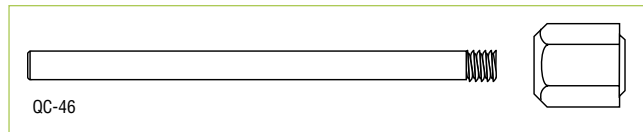

QC-46

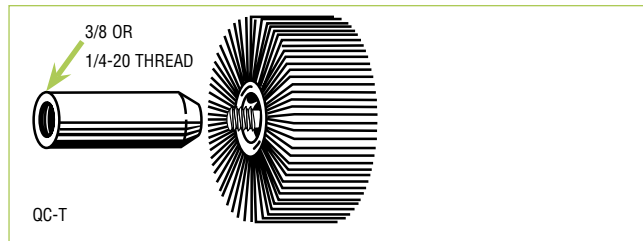

QC-T



Sand-O-Flex Wheels

With their firm cushioning brushes, Sand-O-Flex's abrasive strips are forced into, around and over corners, hollow and fluted surfaces, and small openings. Pressure is distributed evenly over the surface to prevent loss of detail and the flattening of rounded areas; for sanding metals, woods, plastics, rubber and ceramic.

Sand-O-Flex wheels eliminate the need to hand-sand and are designed to fit most standard equipment. They load quickly and easily by turning the index knob as needed, allowing you to change grit size in minutes. Sand-O-Flex refills are available both scored (for finer, less aggressive work) and unscored. And, with the use of Merit adapters, Sand-O-Flex wheels will fit most electric bench grinders.



Sand-O-Flex Wheel – Model 350-RP

- Diameter: 6-1/2" overall, 4" diameter high-impact plastic body
- 1" wide abrasive strips backed by 8 cushioning brushes
- 1/4" diameter steel shank
- Weight: 9-1/2 oz.
- Maximum operating speed: 2,400 RPM
- Special adapter required for bench grinder use
- Some assembly required



AVAILABILITY

TIER:	GOOD
BRAND:	Merit
TRADENAME:	SAND-O-FLEX
ABRASIVE:	Aluminum Oxide

MODEL #	GRIT	STD. PKG.	PART #
Sand-O-Flex Wheel			
350-RP		1	08834111051
Comes assembled with 80 grit A/O resin bond scored refill and brushes			
Sand-O-Flex Accessories			
Bench Grinder Adapter 350-RP 1/4 shank to 1/2 shank		1	08834111055
Replacement Brushes for 350-RP; 8 per set		1 set	08834113003
Resin Bond Refills			
350-RP SCORED	60	10	08834111052
	80	10	08834111053
	100	10	08834112114
	120	10	08834111054
	180	10	08834111057
Glue Bond Refills			
350-RP SCORED	80	10	08834112054
	100	10	08834112055
	120	10	08834112056
	180	10	08834112058
350-RP UNSCORED	80	10	08834112044
	180	10	08834112048





CATEGORY DEFINITION

Best product for blending and polishing contours when smooth running is a primary concern. Used for finishing hard-to-reach areas, removing parting lines, imperfections, and burrs on all surfaces.

- BENEFITS:**
- Spiral construction avoids shadow marks and provides smooth, chatter-free cutting action
 - Achieves close tolerances when finishing curved, contoured, and hard-to-reach areas
 - Fast cutting and removes toughest metal
 - Bands are easily removed and replaced
- GRIT RANGE:** 24 - 320
- ABRASIVE GRAIN:** Aluminum Oxide
- OTHER:** Use with rubber expanding drum

APPLICATION/GRIT RECOMMENDATION GUIDE

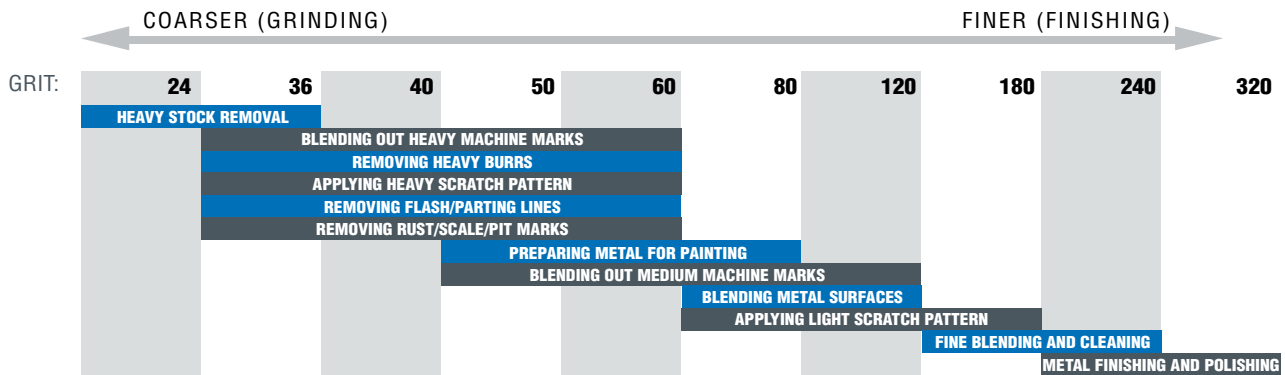

AVAILABILITY

BRAND: ABRASIVE:	GOOD							
	Merit Aluminum Oxide							

GRIT	1/4 x 1/2	1/4 x 1	3/8 x 1/2	3/8 x 1	1/2 x 1/2	1/2 x 1	1/2 x 1-1/2	1/2 x 2
24	-	-	-	-	-	08834196712	-	-
36	-	-	-	08834197674	08834196619	08834196591	08834196237	08834196758
40	08834196614	-	-	-	08834196234	08834196174	-	08834196825
50	08834196292	08834196785	08834196386	-	08834196228	08834196214	08834197111	08834196548
60	08834196342	08834196886	08834196829	08834196999	08834196068	08834196212	08834196053	08834196549
80	08834196269	08834196733	08834196512	08834196645	08834196179	08834196215	08834196646	08834196669
100	08834196511	08834196734	08834196513	-	08834196189	08834196534	08834196540	08834196735
120	08834196217	08834197004	08834196747	08834196218	08834196069	08834196210	08834196324	08834196736
150	08834196327	-	-	-	08834196211	08834196772	-	-
180	08834196490	-	08834196504	-	08834196209	08834196713	-	-
240	-	-	08834196481	-	08834196564	08834196814	-	-
320	08834196865	-	08834196830	-	08834196505	08834196487	-	-
PKG. QTY. STOCK	100/box	100/box	100/box	100/box	100/box	100/box	100/box	100/box
MOQ NON-STOCK	400	400	300	300	300	300	300	200
Expanding Rubber Drums								
	1/8 Shank	NA	1/8 Shank	1/8 Shank	1/4 Shank	1/4 Shank	1/4 Shank	1/4 Shank
	30,000 RPM		30,000 RPM	18,000 RPM	30,000 RPM	15,000 RPM	12,000 RPM	10,000 RPM
	08834196030		08834196944	08834196011	08834196904	08834196906	08834196907	08834196908

SOME MERIT SPECIALTY PART NUMBERS ARE NON-STOCK. ASK YOUR NORTON/MERIT REPRESENTATIVE FOR STOCK/MTO STATUS.



AVAILABILITY

GOOD								
Merit								
Aluminum Oxide								
GRIT	3/4 x 1/2	3/4 x 3/4	3/4 x 1	3/4 x 1-1/2	3/4 x 2	1 x 1/2	1 x 1	1 x 1-1/2
24	-	08834196613	08834196776	08834196596	-	-	08834196563	08834196708
36	08834196769	08834196609	08834196261	08834196238	08834196953	08834196058	08834196072	08834196525
40	08834196605	08834196236	08834196517	08834196227	08834196826	-	08834196073	08834196546
50	08834196608	08834196183	08834196515	08834196500	08834196757	-	08834196184	08834196078
60	08834196578	08834196168	08834196070	08834196554	08834196745	08834196580	08834196075	08834196060
80	08834196255	08834196161	08834196071	08834196249	08834196756	08834196647	08834196074	08834196162
100	08834196567	08834196230	08834196502	08834196501	08834196766	08834196157	08834196167	08834196257
120	08834196579	08834196226	08834196219	08834196057	08834196746	08834197592	08834196177	08834196677
150	08834196631	08834196231	08834196822	-	08834197283	-	08834196686	08834197639
180	08834197116	08834196056	08834196565	08834196851	-	-	08834196059	08834196790
240	08834196603	08834196859	08834196668	-	66254410751	08834197287	08834196178	08834196526
320	08834196806	-	08834196624	08834199664	-	-	08834196789	08834197700
PKG. QTY. STOCK	100/box	100/box	100/box	100/box	100/box	100/box	100/box	100/box
MOQ NON-STOCK	300	300	300	300	200	200	300	200
Expanding Rubber Drums								
	1/4 Shank 27,000 RPM 08834196909	1/4 Shank 24,000 RPM 08834196910	1/4 Shank 17,000 RPM 08834196911	1/4 Shank 10,000 RPM 08834196912	1/4 Shank 10,000 RPM 08834196913	1/4 Shank 20,000 RPM 08834196914	1/4 Shank 18,000 RPM 08834196916	1/4 Shank 10,000 RPM 08834196917

SOME MERIT SPECIALTY PART NUMBERS ARE NON-STOCK. ASK YOUR NORTON/MERIT REPRESENTATIVE FOR STOCK/MTO STATUS.

GOOD								
Merit								
Aluminum Oxide								
GRIT	1 x 2	1 x 3	1-1/2 x 1	1-1/2 x 1-1/2	1-1/2 x 2	1-1/2 x 3	2 x 1	2 x 1-1/2
24	08834196709	08834197806	08834196684	08834196220	08834196539	-	08834196841	08834196700
36	08834196267	08834196665	08834196222	08834196164	08834196657	08834197063	08834196233	08834196509
40	08834196689	-	08834196223	08834196171	08834196598	-	08834196109	08834196514
50	08834196588	08834197688	08834196185	08834196176	08834196252	-	08834196186	08834196527
60	08834196506	08834196676	08834196503	08834196091	08834196067	08834196703	08834196232	08834196978
80	08834196268	08834196195	08834196254	08834196165	08834196533	08834196809	08834196166	08834196259
100	08834196750	08834196445	08834196216	08834196182	08834196543	08834196522	08834196508	08834196521
120	08834196507	08834196197	08834196707	08834196066	08834196079	08834196343	08834196595	08834196586
150	08834197664	-	08834196989	08834197750	08834197376	-	-	-
180	08834196987	08834196356	-	08834196535	-	08834197869	08834196661	08834196536
240	-	-	08834196491	08834196260	08834197709	-	08834197983	-
320	-	-	08834196063	08834197647	-	-	-	-
PKG. QTY. STOCK	100/box	100/box	100/box	100/box	100/box	100/box	100/box	100/box
MOQ NON-STOCK	200	100	300	200	200	100	200	200
Expanding Rubber Drums								
	1/4 Shank 8,000 RPM 08834196918	NA	1/4 Shank 12,000 RPM 08834196921	1/4 Shank 10,000 RPM 08834196922	1/4 Shank 8,000 RPM 08834196923	NA	1/4 Shank 11,000 RPM 08834196926	1/4 Shank 8,000 RPM 08834196927

SOME MERIT SPECIALTY PART NUMBERS ARE NON-STOCK. ASK YOUR NORTON/MERIT REPRESENTATIVE FOR STOCK/MTO STATUS.

GOOD							
Merit							
Aluminum Oxide							
GRIT	2 x 2	2 x 3	2-1/4 x 3	3 x 1	3 x 1-1/2	3 x 2	3 x 3
24	08834196516	08834197903	-	08834196795	-	08834196263	08834196256
36	08834196110	08834196827	08834197140	08834196717	08834196802	08834196545	08834196262
40	08834196172	08834196151	08834197158	08834196755	-	08834196090	08834196555
50	08834196187	08834196152	08834196620	-	-	08834196264	08834196253
60	08834196173	08834196175	-	08834196150	08834196719	08834196530	08834196188
80	08834196181	08834196198	08834196270	08834196524	08834196633	08834196265	08834196159
100	08834196193	08834196199	-	08834196831	-	-	08834196250
120	08834196585	08834196200	08834196729	08834196089	-	08834196531	08834196572
150	08834196629	-	08834195857	-	-	-	08834196452
180	08834196306	-	-	-	-	-	08834196131
240	08834196375	-	-	-	-	-	08834196574
320	08834196628	-	08834195825	-	-	-	08834197968
PKG. QTY. STOCK	100/box	100/box	100/box	100/box	100/box	100/box	100/box
MOQ NON-STOCK	200	100	100	200	200	100	100
Expanding Rubber Drums							
	1/4 Shank 6,000 RPM 08834196928	NA	NA	3/8 Shank 3,000 RPM 08834196929	NA	3/8 Shank 3,000 RPM 08834196930	3/8 Shank 3,000 RPM 08834196931

SOME MERIT SPECIALTY PART NUMBERS ARE NON-STOCK. ASK YOUR NORTON/MERIT REPRESENTATIVE FOR STOCK/MTO STATUS.



CATEGORY DEFINITION

Cartridge, spiral rolls and cone points are strips of abrasive cloth rolled and glued to form a solid shape that is designed to break down during use and reveal the next layer of abrasive.

APPLICATIONS: Used on inside surfaces and inside corners where other abrasive shapes cannot reach. Typically these are used on high-speed air grinders and are always mounted on a mandrel. Ideal for flash removal, polishing, or removing machine tool marks, and edge breaking.

SHAPES: Cartridge rolls, spiral rolls (full taper, half taper, and sidewall taper), and tapered cone points

GRIT RANGE: 36 - 320

ABRASIVE GRAIN: Ceramic Alumina, Aluminum Oxide, Silicon Carbide

BACKING: Cotton Cloth

MAXIMUM RPM: 1/8" to 1/2" – 23,000
5/8" to 1" – 18,000
1" to 1-1/2" – 15,000

APPLICATION/GRIT RECOMMENDATION GUIDE

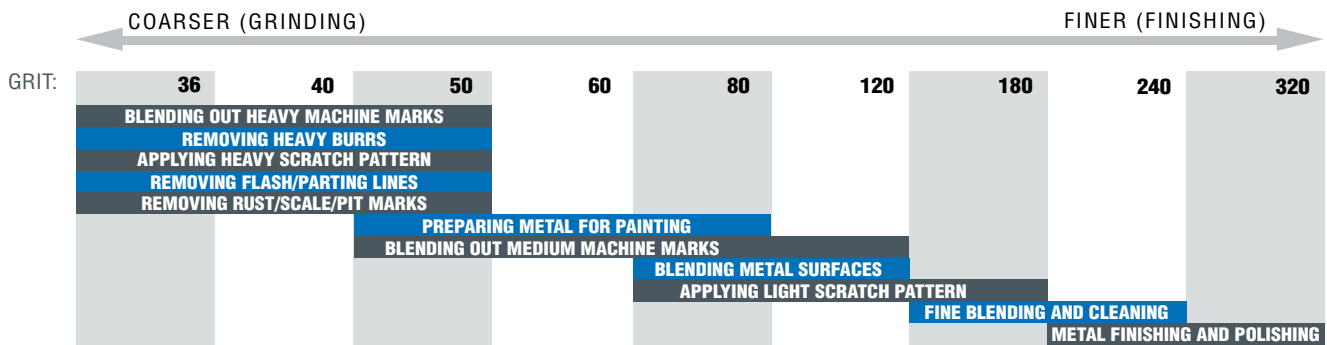

Cartridge Rolls

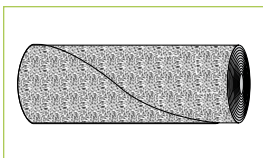

- Effective for flash removal
- Polishing or removing machine tool marks
- Edge breaking
- Valuable abrasive tool for reaching into corners, where larger diameter tools cannot work
- All cartridge roll part numbers shown are resin bond, half-glued
- Quarter and full glue are also available for quotation as made-to-order products

Refer to the back of this section for mandrels.

FEATURED PRODUCTS



MERIT CERAMIC ALUMINA CARTRIDGE ROLLS

BEST CHOICE FOR HARD-TO-GRIND MATERIALS – STAINLESS STEEL, COBALT, INCONEL, AND TITANIUM

FEATURES

- Next-generation ceramic alumina abrasive grain
- Advanced grinding aid
- Improved resin bond system
- Strong X-weight cotton backing

BENEFITS

- Greatest productivity with significantly faster cut rates
- Resists wear, resulting in 50% – 300% longer life
- Cooler cutting, longer life
- Exceptional grain retention and longer life
- Durability and even wear

AVAILABILITY

TIER:	BEST
BRAND:	Merit
ABRASIVE:	Ceramic Alumina
BACKING:	Cotton
OTHER:	Supersized

SIZE (D x L x H)	GRIT	STD. PKG.	PART #
1/4 x 1-1/2 x 1/8	60	100	66261194384
Use M-9 Mandrel	80	100	66261194394
	120	100	66261194397
3/8 x 1-1/2 x 1/8	60	100	66261194392
Use M-9 Mandrel	80	100	66261194395
	120	100	66261194398

CONTINUED

AVAILABILITY

TIER:	BEST
BRAND:	Merit
ABRASIVE:	Ceramic Alumina
BACKING:	Cotton
OTHER:	Supersized

SIZE (D x L x H)	GRIT	STD. PKG.	PART #
1/2 x 1-1/2 x 1/8	60	100	66261194393
Use M-9 Mandrel	80	100	66261194396
	120	100	66261194399



NEW

MERIT CERAMIC ALUMINA BLEND CARTRIDGE ROLLS

BETTER CHOICE FOR STAINLESS STEEL AND OTHER HARD-TO-GRIND MATERIALS

FEATURES

- Sharp ceramic alumina abrasive blend
- Durable X-weight cotton backing
- Grinding aid

BENEFITS

- Delivers cooler cut
- Ensures even wear
- Promotes cooler cut on stainless steel

AVAILABILITY

TIER:	BETTER
BRAND:	Merit
ABRASIVE:	Ceramic Alumina Blend
BACKING:	Cotton
OTHER:	Supersized

SIZE (D x L x H)	GRIT	STD. PKG.	PART #
1/4 x 1-1/2 x 1/8	60	100	66261040477
Use M-9 Mandrel	80	100	69957300001
3/8 x 1-1/2 x 1/8	60	100	66261041270
Use M-9 Mandrel	80	100	08834187134

CONTINUED

AVAILABILITY

TIER:	BETTER
BRAND:	Merit
ABRASIVE:	Ceramic Alumina Blend
BACKING:	Cotton
OTHER:	Supersized

SIZE (D x L x H)	GRIT	STD. PKG.	PART #
1/2 x 1-1/2 x 1/8	60	100	08834184221
Use M-9 Mandrel	80	100	66261012798



NEW

MERIT ALUMINUM OXIDE PLUS CARTRIDGE ROLLS

EFFECTIVE STARTING SPECIFICATION FOR FLASH REMOVAL, POLISHING, OR REMOVING MACHINE TOOL MARKS AND EDGE BREAKING ON ALL TYPES OF METAL

FEATURES

- Premium aluminum oxide abrasive
- Advanced, full resin bond system

BENEFITS

- Controls aggressiveness while cool cutting
- Ensures edge adhesion and long life

AVAILABILITY

TIER:	GOOD
BRAND:	Merit
ABRASIVE:	Premium Aluminum Oxide
BACKING:	Cotton
OTHER:	Supersized

SIZE (D x L x H)	GRIT	STD. PKG.	PART #
1/4 x 1-1/2 x 1/8	60	100	77696089001
Use M-9 Mandrel	80	100	77696089002
	120	100	77696089003
3/8 x 1-1/2 x 1/8	60	100	77696089004
Use M-9 Mandrel	80	100	77696089005
	120	100	77696089006

CONTINUED

AVAILABILITY

TIER:	GOOD
BRAND:	Merit
ABRASIVE:	Premium Aluminum Oxide
BACKING:	Cotton
OTHER:	Supersized

SIZE (D x L x H)	GRIT	STD. PKG.	PART #
1/2 x 1-1/2 x 1/8	60	100	77696089007
Use M-9 Mandrel	80	100	77696089008
	120	100	77696089009

Refer to the back of this section for mandrels.
Email: panamericandistribution@gmail.com



MERIT ALUMINUM OXIDE CARTRIDGE ROLLS

GOOD STARTING SPECIFICATION FOR FLASH REMOVAL, POLISHING, OR REMOVING MACHINE TOOL MARKS AND EDGE BREAKING ON ALL TYPES OF METAL

FEATURES

- Quality aluminum oxide abrasive
- Strong X-weight cotton backing construction
- Durable resin bond system

BENEFITS

- Tough and durable
- For extended durability and even wear
- Provides longer life

AVAILABILITY

TIER:	GOOD
BRAND:	Merit
ABRASIVE:	Aluminum Oxide
BACKING:	Cotton Cloth

SIZE (D x L x H)	GRIT	STD. PKG.	PART #
3/16 x 3/4 x 3/32	80	100	08834180005
3/16 x 1 x 3/32	60	100	08834180023
Use M-2E Mandrel	80	100	08834180024
	100	100	08834180025
	120	100	08834180026
	150	100	08834180027
	180	100	08834180028
	240	100	08834180030
	320	100	08834180032
1/4 x 3/4 x 1/8	60	100	08834180042
Use M-3 or M-7 Mandrel	80	100	08834180043
	120	100	08834180045
1/4 x 1 x 1/8	50	100	08834180060
Use M-4 or M-8 Mandrel	60	100	08834180061
	80	100	08834180062
	100	100	08834180063
	120	100	08834180064
	150	100	08834180065
	180	100	08834180066
	240	100	08834180068
	320	100	08834180070
1/4 x 1-1/2 x 1/8	50	100	08834180079
Use M-9 Mandrel	60	100	08834180080
	80	100	08834180081
	100	100	08834180082
	120	100	08834180083
	150	100	08834180084
	180	100	08834180085
	320	100	08834180089
1/4 x 2 x 1/8	80	100	08834180100
Use M-10 Mandrel	100	100	08834180101
	120	100	08834180102
5/16 x 1 x 1/8	60	100	08834180137
use M-4 or M-8 Mandrel	80	100	08834180138
	120	100	08834180140
5/16 x 1-1/2 x 1/8	60	100	08834180156
use M-9 Mandrel	80	100	08834180157
	120	100	08834180159
3/8 x 3/4 x 1/8	60	100	08834180194
use M-7 Mandrel	80	100	08834180195
	120	100	08834180197
3/8 x 1 x 1/8	40	100	08834180211
use M-8 Mandrel	50	100	08834180212
	60	100	08834180213
	80	100	08834180214
	100	100	08834180215
	120	100	08834180216
	150	100	08834180217
	180	100	08834180218
	240	100	08834180220

SOME MERIT PART NUMBERS ARE NON-STOCK. ASK YOUR NORTON/MERIT REPRESENTATIVE FOR STOCK/MTO STATUS.

CONTINUED

AVAILABILITY

TIER:	GOOD
BRAND:	Merit
ABRASIVE:	Aluminum Oxide
BACKING:	Cotton

SIZE (D x L x H)	GRIT	STD. PKG.	PART #
3/8 x 1-1/2 x 1/8	36	100	08834180228
use M-9 Mandrel	40	100	08834180229
	50	100	08834180230
	60	100	08834180231
	80	100	08834180232
	100	100	08834180233
	120	100	08834180234
	150	100	08834180235
	180	100	08834180236
	240	100	08834180238
	320	100	08834180240
3/8 x 2 x 1/8	60	100	08834180250
use M-10 Mandrel	80	100	08834180251
	100	100	08834180252
	120	100	08834180253
1/2 x 3/4 x 1/8	80	100	08834180270
use M-7 Mandrel			
1/2 x 1 x 1/8	40	100	08834180286
use M-8 Mandrel	50	100	08834180287
	60	100	08834180288
	80	100	08834180289
	100	100	08834180290
	120	100	08834180291
	150	100	08834180292
	180	100	08834180293
	240	100	08834180295
	320	100	08834180297
1/2 x 1-1/2 x 1/8	36	100	08834180304
use M-9 Mandrel	40	100	08834180305
	50	100	08834180306
	60	100	08834180307
	80	100	08834180308
	100	100	08834180309
	120	100	08834180310
	150	100	08834180311
	180	100	08834180312
	240	100	08834180314
	320	100	08834180316
1/2 x 1-1/2 x 3/16	120	100	08834180919
use M-16 Mandrel			
1/2 x 2 x 1/8	60	100	08834180326
use M-10 Mandrel	80	100	08834180327
	100	100	08834180328
	120	100	08834180329
	180	100	08834180331
	240	100	08834180333
	320	100	08834180335
1/2 x 2 x 3/16	60	100	08834180350
use M-17 Mandrel	80	100	08834180653
	120	100	08834180338
1/2 x 2 x 1/4	40	100	08834183168
use M-22 Mandrel	80	100	08834180351
5/8 x 1 x 3/16	80	100	08834180364
use M-15 Mandrel			

CONTINUED

Refer to the back of this section for mandrels.

AVAILABILITY

TIER: **GOOD**
BRAND: Merit
ABRASIVE: Aluminum Oxide
BACKING: Cotton

SIZE (D x L x H)	GRIT	STD. PKG.	PART #
5/8 x 1-1/2 x 1/8 use M-9 Mandrel	36	100	08834180395
	40	100	08834180392
	50	100	08834180393
	60	100	08834180275
	80	100	08834180789
5/8 x 1-1/2 x 3/16 use M-16 Mandrel	120	100	08834180394
	50	100	08834180381
	60	100	08834180382
5/8 x 2 x 1/8 use M-10 Mandrel	80	100	08834180383
	60	100	08834182505
	80	100	08834181080
5/8 x 2 x 3/16 use M-10 Mandrel	80	100	08834181080
	50	100	08834180400
	60	100	08834180401
	80	100	08834180402
3/4 x 1 x 1/8 use M-8 Mandrel	100	100	08834180403
	80	100	08834180469
	120	100	08834181543
3/4 x 1 x 3/16 use M-15 Mandrel	40	100	08834180456
	80	100	08834180459
	120	100	08834180461
3/4 x 1-1/2 x 1/8 use M-9 Mandrel	40	100	08834180069
	60	100	08834180490
	80	100	08834180527
	120	100	08834180487
3/4 x 1-1/2 x 3/16 use M-16 Mandrel	36	100	08834180474
	40	100	08834180475
	50	100	08834180476
	60	100	08834180477
	80	100	08834180478
	100	100	08834180479
	120	100	08834180480
180	100	08834180482	

CONTINUED

AVAILABILITY

TIER: **GOOD**
BRAND: Merit
ABRASIVE: Aluminum Oxide
BACKING: Cotton

SIZE (D x L x H)	GRIT	STD. PKG.	PART #
3/4 x 1-1/2 x 1/4 100/box 400/case use M-21 Mandrel	36	100	08834180907
	60	100	08834180489
	80	100	08834180358
	100	100	08834180523
	120	100	08834180488
	150	100	08834182807
3/4 x 2 x 1/8 use M-10 Mandrel	60	100	08834180791
	40	100	08834180494
3/4 x 2 x 3/16 use M-17 Mandrel	60	100	08834180496
	80	100	08834180497
	100	100	08834180498
	120	100	08834180499
3/4 x 2 x 1/4 use M-22 Mandrel	60	100	08834180506
	80	100	08834181297
	100	100	08834180509
1 x 1-1/2 x 1/8 use M-9 Mandrel	120	100	08834180507
	60	100	08834180580
	80	100	08834180584
1 x 1-1/2 x 1/4 use M-21 Mandrel	36	100	08834181195
	60	100	08834180587
	80	100	08834180583
1 x 2 x 3/16 use M-17 Mandrel	40	100	08834180589
	60	100	08834180591
	80	100	08834180592
1 x 2 x 1/4 use M-22 Mandrel	60	100	08834180603
	80	100	08834180606
	120	100	08834180585

SOME MERIT PART NUMBERS ARE NON-STOCK. ASK YOUR NORTON/MERIT REPRESENTATIVE FOR STOCK/MTO STATUS.



MERIT SILICON CARBIDE CARTRIDGE ROLLS

GOOD CHOICE FOR TOUGH, DIFFICULT-TO-GRIND MATERIALS, AS WELL AS SOFT, LOADING MATERIALS

FEATURES

- Sharp silicon carbide abrasive
- Durable resin bond system

BENEFITS

- Provides high initial cut on non-ferrous and soft-loading materials such as titanium, masonry, composites, plastic, and rubber
- Exceptional grain retention and longer life

AVAILABILITY

TIER: **GOOD**
BRAND: Merit
ABRASIVE: Silicon Carbide
BACKING: Cotton

SIZE (D x L x H)	GRIT	STD. PKG.	PART #
1/4 x 1-1/2 x 1/8 Use M-9 Mandrel	60	100	08834183274
	80	100	08834182359
	120	100	08834189131
3/8 x 1-1/2 x 1/8 Use M-9 Mandrel	60	100	08834181309
	80	100	08834180710
	120	100	66261042229

CONTINUED

AVAILABILITY

TIER: **GOOD**
BRAND: Merit
ABRASIVE: Silicon Carbide
BACKING: Cotton

SIZE (D x L x H)	GRIT	STD. PKG.	PART #
1/2 x 1-1/2 x 1/8 Use M-9 Mandrel	60	100	08834189233
	80	100	08834180712
	120	100	66261086969

Refer to the back of this section for mandrels.

Spiral Rolls

- All spiral roll part numbers shown are full tapered, resin bond, half glued
- Half-tapered and sidewall-tapered are available for quotation as made-to-order products
- Quarter and full glue are also available for quotation as made-to-order products
- Ceramic Alumina blend spiral rolls are also available for quotation as made-to-order products

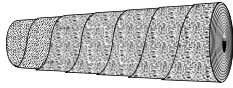

Full Taper

- Especially useful for grinding/polishing of channels, fillets and radii, and deburring small holes
- Full taper used when the area to finished is hard to reach with a full cartridge roll
- The tapered roll conforms to smaller areas
- Fits into irregular concaves, contours, channels

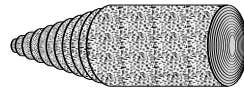

Half Taper

- Used when the area to be finished is not narrow but a beginning point on the roll is needed
- The portion of the roll that is not tapered is then used to finish off the sides

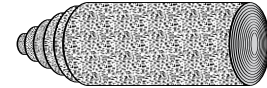

Sidewall Taper

- The portion of the roll that is tapered guides the roll down to the area to be finished
- The sidewall then finishes off the sides

FEATURED PRODUCTS



MERIT CERAMIC ALUMINA SPIRAL ROLLS – FULL TAPER

BEST CHOICE FOR HARD-TO-GRIND MATERIALS – STAINLESS STEEL, COBALT, INCONEL, AND TITANIUM

FEATURES

- Next-generation ceramic alumina abrasive grain
- Advanced grinding aid
- Improved resin bond system
- Strong X-weight cotton backing

BENEFITS

- Greatest productivity with significantly faster cut rates
- Resists wear, resulting in 50% – 300% longer life
- Cooler cutting, longer life
- Exceptional grain retention and longer life
- Durability and even wear

AVAILABILITY

TIER:	BEST
BRAND:	Merit
ABRASIVE:	Ceramic Alumina
BACKING:	Cotton
OTHER:	Supersized

SIZE (D x L x H)	GRIT	STD. PKG.	PART #
3/8 x 1-1/2 x 1/8	60	100	66261194481
Use M-9 Mandrel	80	100	66261194490
	120	100	66261194491

CONTINUED

AVAILABILITY

TIER:	BEST
BRAND:	Merit
ABRASIVE:	Ceramic Alumina
BACKING:	Cotton
OTHER:	Supersized

SIZE (D x L x H)	GRIT	STD. PKG.	PART #
1/2 x 1-1/2 x 1/8	60	100	66261194484
Use M-9 Mandrel	80	100	66261194492
	120	100	66261194495



NEW

MERIT ALUMINUM OXIDE PLUS SPIRAL ROLLS – FULL TAPER

ESPECIALLY USEFUL FOR COOLER GRINDING/POLISHING OF CHANNELS, FILLETS AND RADII, AND DEBURRING SMALL HOLES..

FEATURES

- Premium aluminum oxide abrasive
- Strong X-weight cotton backing construction
- Advanced, full resin bond system

BENEFITS

- Runs cooler and more efficiently; ideal for grinding exotic alloys
- For extended durability and even wear
- Provides exceptional grain retention and longer life

AVAILABILITY

TIER:	GOOD
BRAND:	Merit
ABRASIVE:	Premium Aluminum Oxide
BACKING:	Cotton

SIZE (D x L x H)	GRIT	STD. PKG.	PART #
3/8 x 1-1/2 x 1/8	60	100	77696089010
use M-9 Mandrel	80	100	77696089011
	120	100	77696089012

CONTINUED

TIER:	GOOD
BRAND:	Merit
ABRASIVE:	Premium Aluminum Oxide
BACKING:	Cotton

SIZE (D x L x H)	GRIT	STD. PKG.	PART #
1/2 x 1-1/2 x 1/8	60	100	77696089013
use M-9 Mandrel	80	100	77696089014
	120	100	77696089015

Refer to the back of this section for mandrels.



MERIT ALUMINUM OXIDE SPIRAL ROLLS – FULL TAPER

ESPECIALLY USEFUL FOR COOLER GRINDING/POLISHING OF CHANNELS, FILLETS AND RADII, AND DEBURRING SMALL HOLES..

FEATURES

- Quality aluminum oxide abrasive
- Strong X-weight cotton backing construction
- Durable resin bond system

BENEFITS

- For the buyer whose major purchasing criterion is low initial price
- Durability and even wear
- Exceptional grain adhesion and longer life

AVAILABILITY

TIER:	GOOD
BRAND:	Merit
ABRASIVE:	Aluminum Oxide
BACKING:	Cotton

SIZE (D x L x H)	GRIT	STD. PKG.	PART #
3/8 x 1 x 1/8	60	100	08834181714
use M-8 Mandrel	80	100	08834181715
	120	100	08834181717
	180	100	08834181719
3/8 x 1-1/2 x 1/8	50	100	08834181723
use M-9 Mandrel	60	100	08834181724
	80	100	08834181708
	120	100	08834181727
	150	100	08834181728
	180	100	08834181709
1/2 x 1 x 1/8	60	100	08834181734
use M-8 Mandrel	80	100	08834181735
	120	100	08834181737
	180	100	08834181739
1/2 x 1-1/2 x 1/8	36	100	08834181230
use M-9 Mandrel	40	100	08834181742
	50	100	08834181743
	60	100	08834181744
	80	100	08834181745
	100	100	08834181746
	120	100	08834181747
	180	100	08834181749
	240	100	08834181750

CONTINUED

TIER:	GOOD
BRAND:	Merit
ABRASIVE:	Aluminum Oxide
BACKING:	Cotton

SIZE (D x L x H)	GRIT	STD. PKG.	PART #
1/2 x 2 x 1/8	60	100	08834181754
use M-10 Mandrel	80	100	08834181755
	120	100	08834181757
5/8 x 1-1/2 x 1/8	100	100	08834181776
use M-9 Mandrel	120	100	08834181777
	240	100	08834183313
	320	100	08834181781
5/8 x 1-1/2 x 3/16	80	100	08834181444
use M-16 Mandrel			
3/4 x 1-1/2 x 1/8	60	100	08834181286
use M-9 Mandrel	80	100	08834180886
3/4 x 1-1/2 x 3/16	50	100	08834181807
use M-16 Mandrel	60	100	08834181808
	80	100	08834181809
	120	100	08834181811
3/4 x 2 x 3/16	60	100	08834181820
use M-17 Mandrel			
1 x 1-1/2 x 1/8	60	100	08834181240
use M-9 Mandrel			
1 x 2 x 3/16	36	100	08834181875
use M-17 Mandrel	60	100	08834181878
	80	100	08834181879

SOME MERIT PART NUMBERS ARE NON-STOCK. ASK YOUR NORTON/MERIT REPRESENTATIVE FOR STOCK/MTO STATUS.



MERIT SILICON CARBIDE SPIRAL ROLLS – FULL TAPER

GOOD CHOICE FOR TOUGH, DIFFICULT-TO-GRIND MATERIALS, AS WELL AS SOFT, LOADING MATERIALS

FEATURES

- Sharp silicon carbide abrasive
- Durable resin bond system

BENEFITS

- Provides high initial cut on non-ferrous and soft-loading materials such as titanium, masonry, composites, plastic, and rubber
- Exceptional grain retention and longer life

AVAILABILITY

TIER:	GOOD
BRAND:	Merit
ABRASIVE:	Silicon Carbide
BACKING:	Cotton

SIZE (D x L x H)	GRIT	STD. PKG.	PART #
3/8 x 1-1/2 x 1/8	60	100	08834189901
use M-9 Mandrel	80	100	08834189904
	120	100	66261046936

CONTINUED

AVAILABILITY

TIER:	GOOD
BRAND:	Merit
ABRASIVE:	Silicon Carbide
BACKING:	Cotton

SIZE (D x L x H)	GRIT	STD. PKG.	PART #
1/2 x 1-1/2 x 1/8	60	100	66261185977
use M-9 Mandrel	80	100	08834183460
	120	100	08834183448

Refer to the back of this section for mandrels.

Tapered Cone Points



- Tapered cone points are similar to cartridge rolls but their shape lends greater accessibility to many difficult-to-reach work areas
- They are used for deburring holes and in close tolerance work areas
- Popular sizes and mandrels are listed, with additional sizes available upon request as made-to-order products
- Ceramic alumina, ceramic alumina blend, aluminum oxide plus, and silicon carbide cone points are available upon request as made-to-order products

FEATURED PRODUCTS



MERIT ALUMINUM OXIDE TAPERED CONE POINTS

GOOD STARTING SPECIFICATION FOR FLASH REMOVAL, POLISHING, OR REMOVING MACHINE TOOL MARKS AND EDGE BREAKING ON ALL TYPES OF METAL IN DIFFICULT-TO-REACH WORK AREAS.

FEATURES

- Quality aluminum oxide abrasive
- Strong X-weight cotton backing construction
- Durable resin bond system

BENEFITS

- Tough and durable
- For extended durability and even wear
- Provides longer life

AVAILABILITY

TIER:	GOOD		
BRAND:	Merit		
ABRASIVE:	Aluminum Oxide		
BACKING:	Cotton		
SIZE (D x L x H)	GRIT	STD. PKG.	PART #
5/16 x 1-1/2 x 5°	80	500	08834180873
Use B-20 Mandrel	100	500	08834182043
	120	500	08834182717
	150	500	08834186890
	180	500	08834182535
	240	500	08834182044
	320	500	08834182537

CONTINUED

AVAILABILITY

TIER:	GOOD		
BRAND:	Merit		
ABRASIVE:	Aluminum Oxide		
BACKING:	Cotton		
SIZE (D x L x H)	GRIT	STD. PKG.	PART #
3/16 x 1 x 2-1/2°	50	500	08834186892
Use K-110 Mandrel	60	500	08834186893
	80	500	08834180918
	100	500	08834182197
	120	500	08834182199
	150	500	08834182200
	180	500	08834186894
	240	500	08834186895
	320	500	08834182855

Test Kits



Merit Ceramic Alumina Cartridge Roll Test Kit

- Part # 66261066726
- Kit includes a variety of our Merit ceramic alumina cartridge rolls, spiral rolls and mandrels in popular sizes and grits.

Merit Aluminum Oxide Cartridge Roll Test Kit "CR"

- Part # 08834181061
- Includes over 120 pieces of our most popular sizes, grits and shapes with their appropriate mandrels.

Merit General Purpose Test Kit "GP"

- Part # 08834169025
- Includes samples of various Merit abrasive specialties. One of these kits could be worth the cost of the entire kit by solving your problems in deburring, polishing and grinding.

Merit Porting Test Kit "APK-MO"

- Part # 08834169032
- The samples in this kit highlight Merit specialties for general metal and wood working polishing and finishing applications.

Cartridge and Spiral Roll Mandrels

MODEL #	PILOT DIA.	PILOT LENGTH	SHANK DIA.	SHANK LENGTH	OVERALL LENGTH	PART #
Cartridge and Spiral Roll Mandrels						
M-2E	3/32	3/4	1/4	1	3	08834183799
M-2	3/32	1	1/8	1	3	08834181202
M-3	1/8	1/2	1/8	1	2-1/2	08834181203
M-4	1/8	3/4	1/8	1	2-1/2	08834181204
M-5	1/8	1	1/8	1	2-3/4	08834181205
M-6	1/8	1-1/2	1/8	1	2-1/2	08834181206
M-7	1/8	1/2	1/4	1-1/4	2-1/4	08834181207
M-8	1/8	3/4	1/4	1-1/4	2-1/2	08834181208
M-9	1/8	1	1/4	1-1/4	2-3/4	08834181209
M-10	1/8	1-1/2	1/4	1-1/4	3-1/4	08834181210
M-11	1/8	2	1/4	1-1/4	4	08834181211
M-12	3/16	1/2	1/8	1-1/4	2-1/4	08834181212
M-13	3/16	3/4	1/8	1-1/4	2-1/2	08834181213
M-14	3/16	1/2	1/4	1-1/4	2-1/2	08834181214
M-15	3/16	3/4	1/4	1-1/4	2-3/4	08834181215
M-16	3/16	1	1/4	1-1/4	3	08834181216
M-17	3/16	1-1/2	1/4	1-1/4	3-1/2	08834181217
M-18	3/16	2	1/4	1-1/4	4	08834181218
M-19	1/4	1/2	1/4	1-1/4	2-1/2	08834181219
M-20	1/4	3/4	1/4	1-1/4	2-3/4	08834181220
M-21	1/4	1	1/4	1-1/4	3	08834181221
M-22	1/4	1-1/2	1/4	1-1/4	3-1/2	08834181222
M-23	1/4	2	1/4	1-1/4	4	08834181223
M-24	5/16	3/4	1/4	1-1/4	2-3/4	08834181224
M-25	5/16	1	1/4	1-1/4	3	08834181225
M-26	5/16	1-1/2	1/4	1-1/4	3-1/2	08834181226
M-27	5/16	2	1/4	1-1/4	4	08834181227

STANDARD PACKAGE = 1

Recommended Pilot Length for Mandrels

3/4 Roll Length	use 1/2 Pilot
1 Roll Length	use 3/4 Pilot
1-1/2 Roll Length	use 1 Pilot
2 Roll Length	use 1-1/2 Pilot

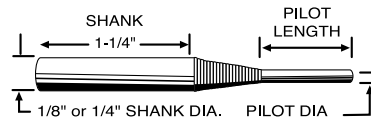

Extra Shank Length Mandrels

MODEL #	SHANK LENGTH	OVERALL LENGTH	PART NO.
Extras Shank Length Mandrels			
M-8-4	4	5-1/4	08834180116
M-8-6	6	7-1/4	08834180122
M-9-2.5	2-1/2	4	08834180096
M-9-3	3	4-1/2	08834180129
M-9-4	4	5-1/2	08834180074
M-9-6	6	7-1/2	08834180131
M-9-8	8	9-1/2	08834180133
M-10-4	1-3/4	4	08834180092
M-10-6	3-3/4	6	08834180145

ALL EXTRA SHANK LENGTH MANDRELS ARE 1/4" DIAMETER
STANDARD PACKAGE = 1

Tapered Cone Point Mandrels

DESCRIPTION	SHANK	PART #
Cone Point Mandrels		
A-10	1/4	08834181300
B-20	1/4	08834181301
C-30	1/4	08834181302
D-40	1/4	08834181303
E-50	A1/4	08834181304
F-60	1/4	08834181305
G-70	1/4	08834181306
H-80	1/4	08834181307
I-90	1/4	08834181308
K-110	1/8	08834181310

STANDARD PACKAGE = 1





CATEGORY DEFINITION

Square pads, cross pads and overlap slotted discs are all used on high-speed pneumatic tools for deburring, blending, cleaning, and polishing applications. All of these abrasive specialties are designed for applications in small, tight, hard-to-access locations on parts that are being finished.

- BENEFITS:** Variety of shapes and sizes to fit application and part geometry
 Shapes provide flexibility for the application, while eliminating aggressiveness of the sanding action
 Cross pads allow visibility of the surface while sanding, to ensure correct amount of material is removed
- GRIT RANGE:** 50 – 180
- ABRASIVE GRAIN:** Ceramic Alumina, Aluminum Oxide
- BACKING:** Cotton
- MAXIMUM RPM:** 1" Diameter – 25,000
 1-1/2" to 2" Diameter – 18,000 to 23,000
 2-1/2" Diameter – 14,000 to 18,000
 3" Diameter – 12,000 to 14,000
 4" Diameter – 8,000 to 12,000
 5" to 6" Diameter – 5,500 to 7,500

APPLICATION/GRIT RECOMMENDATION GUIDE

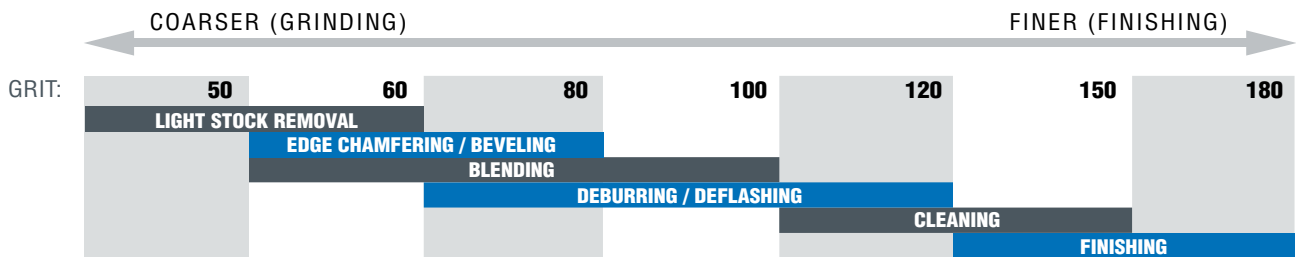

FEATURED PRODUCTS



MERIT CERAMIC ALUMINA

BEST FOR HARD-TO-GROUND MATERIALS – STAINLESS STEEL, COBALT, INCONEL, AND TITANIUM

FEATURES

- Next-generation ceramic alumina abrasive grain
- Advanced grinding aid
- Improved resin bond system

BENEFITS

- Significantly faster cut rates versus any other abrasive
- Resists wear, resulting in 50%-300% longer life
- Greatest productivity; lowest total cost
- Cooler cutting, longer life
- Improved grain retention and longer life



MERIT ALUMINUM OXIDE

GOOD FOR MOST ID DEBURRING AND POLISHING APPLICATIONS

FEATURES

- Quality aluminum oxide abrasive grain
- Resin bond system
- Standard quick-change eyelet for easy mounting and removal on quick-change mandrel

BENEFITS

- Versatile; ideal for deburring, chamfering, and polishing most radii, holes, recesses, and cylinder walls
- Good grain retention and life
- Minimal downtime
- Mandrel use increases range and versatility



Square Pads

AVAILABILITY

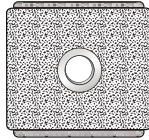

TIER: **BEST**
BRAND: Merit
ABRASIVE: Ceramic Alumina
OTHER: Supersized

TIER: **GOOD**
BRAND: Merit
ABRASIVE: Aluminum Oxide

SIZE (L x W x T)	EYELET	GRIT	STD. PKG.	PART #	PART #
1 x 1 x 6 ply	8-32	80	100		08834184826
1 x 1 x 8 ply	8-32	60	100		08834184828
		80	100		08834184124
		120	100		08834184994
1-1/2 x 1-1/2 x 1/2	1/4-20	60	100		08834184463
		80	100		08834184125
2 x 2 x 1/2	1/4-20	60	100	66261194520	08834184334
		80	100	66261194552	08834184397
		120	100	66261194554	
2 x 2 x 3/4	1/4-20	50	100		08834184487
		80	100		08834184394
3 x 3 x 1/4	1/4-20	60	100	66261194531	
		80	100	66261194555	08834184882
		120	100	66261194556	
3 x 3 x 1/2	1/4-20	50	100		08834182152
		60	100	66261194528	08834182057
		80	100	66261194557	08834184336
		120	100	66261194558	

SOME MERIT PART NUMBERS ARE NON-STOCK. ASK YOUR NORTON/MERIT REPRESENTATIVE FOR STOCK/MTO STATUS.
CERAMIC ALUMINA BLEND AND ALUMINUM OXIDE PLUS SQUARE PADS ARE ALSO AVAILABLE UPON REQUEST AS MADE-TO-ORDER PRODUCTS.

Merit Square Pads

- Corners wear down consistently exposing fresh abrasive; the pad becomes round for less aggressive stock removal
- Grind almost as fast as hard wheels, but are much smoother and easier to control
- For quick blending of channels, fillets, corners, or spotting flat surfaces



Cross Pads

AVAILABILITY

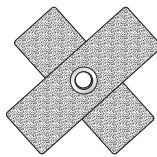

TIER: **BEST**
BRAND: Merit
ABRASIVE: Ceramic Alumina
OTHER: Supersized

TIER: **GOOD**
BRAND: Merit
ABRASIVE: Aluminum Oxide

SIZE (L x W x T)	PLY	EYELET	GRIT	STD. PKG.	PART #	PART #
3/4 x 3/4 x 3/8	8	3-48	80	100		08834185578
1 x 1 x 3/8	8	3-48	60	100		08834184943
			80	100		08834185519
			100	100		08834184195
			120	100		08834185164
1-1/2 x 1-1/2 x 1/2	8	8-32	60	100	66261194496	08834184258
			80	100	66261194508	08834184465
			100	100		08834182196
			120	100	66261194511	08834182148
2 x 2 x 1/2	8	8-32	60	100		08834182156
			80	100		08834182157
			120	100		08834182132
2 x 2 x 3/4	8	8-32	60	100	66261194502	08834184128
			80	100	66261194513	08834184194
			120	100	66261194516	08834184285
2 x 2 x 1	8	8-32	120	100		08834184805
2-1/4 x 2-1/4 x 1/2	8	8-32	80	100		08834184402
2-1/2 x 2-1/2 x 3/4	8	8-32	80	100		08834184206
			120	100		08834184074
3 x 3 x 1	8	1/4-20	60	100	66261194504	08834182135
			80	100	66261194549	08834184119
			120	100	66261194551	08834184116
3 x 3 x 1	10	1/4-20	80	100		08834182140
3 x 3 x 1-1/2	10	1/4-20	80	100		08834182184
4 x 4 x 1	8	1/4-20	60	100		08834184142
			80	100		08834184135
			120	100		08834184377
4 x 4 x 1-1/2	8	1/4-20	80	100		08834184129
			120	100		08834184370

SOME MERIT PART NUMBERS ARE NON-STOCK. ASK YOUR NORTON/MERIT REPRESENTATIVE FOR STOCK/MTO STATUS.
CERAMIC ALUMINA BLEND AND ALUMINUM OXIDE PLUS CROSS PADS ARE ALSO AVAILABLE UPON REQUEST AS MADE-TO-ORDER PRODUCTS.

Refer to the back of this section for mandrels.



Overlap Slotted Discs

AVAILABILITY

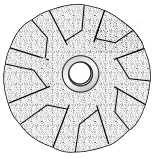

TIER:	BEST	GOOD	GOOD
BRAND:	Merit	Merit	Merit
ABRASIVE:	Ceramic Alumina	Aluminum Oxide	Aluminum Oxide
OTHER:	Supersized, 2-Ply	2 Per Set	4 Per Set

Merit Overlap Slotted Discs

- Used for deburring and polishing radii, holes and cylinder walls
- Our "2 to a set" configuration cuts on the inward motion only
- The "4 to a set" configuration, assembled back to back, cuts on both the inward and outward motions
- All discs are furnished with standard quick-change eyelet
- Plain hole sizes must be specified and are available for quotation as made-to-order products

DIA.	EYELET	GRIT	STD. PKG.	PART #	PART #	PART #
1	8-32	60	100		08834184346	
		80	100		08834184019	08834184085
		100	100		08834184224	
		120	100		08834184151	08834184236
		180	100		08834185078	
1-1/4	8-32	60	100		08834184270	
		80	100		08834184065	
		100	100		08834184291	
		120	100		08834184084	
1-1/2	8-32	60	100	66261195051	08834184066	
		80	100	66261195368	08834184079	
		100	100		08834184279	08834184023
		120	100	66261195367	08834186035	
1-3/4	8-32	60	100		08834184498	
		80	100		08834184655	
2	8-32	60	100	66261195054	08834184042	
		80	100	66261195055	08834184076	
		100	100		08834184145	
2-1/2	8-32	120	100	66261195056	08834184055	
		80	100		08834184444	
		100	100		08834184818	
3	1/4-20	50	100		08834184818	
		60	100	66261195057	08834184041	
		80	100	66261195058	08834184077	
		100	100		08834184082	
4	1/4-20	120	100	66261195059	08834184344	
		60	100		08834184000	
		100	100		08834184159	
4-1/2	1/4-20	120	100		08834185155	
		60	100		08834184431	
		100	100		08834184302	
5	1/4-20	100	100			

SOME MERIT PART NUMBERS ARE NON-STOCK. ASK YOUR NORTON/MERIT REPRESENTATIVE FOR STOCK/MTO STATUS.
ALL OVERLAP SLOTTED DISCS ARE AVAILABLE (MADE-TO-ORDER) REINFORCED WITH A FIBER WASHER
CERAMIC ALUMINA BLEND AND ALUMINUM OXIDE PLUS OVERLAP SLOTTED DISCS ARE ALSO AVAILABLE UPON REQUEST AS MADE-TO-ORDER PRODUCTS.

Quick-Change Mandrels for Overlap Slotted Discs, Square and Cross Pads

CROSS PAD SIZE DIA.	SQUARE PAD SIZE DIA.	OAL	MODEL NO.	THD. SIZE	PART #
1/4, 3/8, and 1/2 wide		2-1/2	MM48-4	3-48	08834183162
3/4, 1 wide	Up thru 1-1/2 sq. x 1/2 thick 2 sq. x 1/4 or 3/8 thick	3	MM32-4	8-32	08834183163
		4	MM-32-4-4	8-32	08834121680
		6	MM-32-4-6	8-32	08834121681
All pads 2-1/2 x 1-1/2 and larger	2 sq. x 1/4 or 1/2 thick and larger	3	MM20-4	1/4-20	08834183164

FOR OVERLAP SLOTTED DISCS, CHOOSE A MANDREL WITH THE SAME THREAD SIZE AS THE DISC

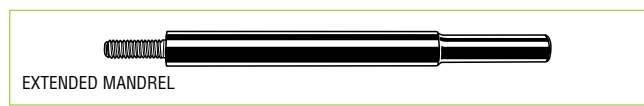
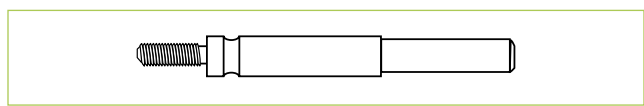

EXTENDED MANDREL



CATEGORY DEFINITION

Flaps of abrasive cloth are stacked, inserted into a holder, and then attached to a mandrel. The flaps are designed to break down during use and reveal the next layer of abrasive.

Cloth flaps are mixed with non-woven flaps to create an interleaf bore polisher.

APPLICATIONS: For deburring, sizing, cleaning and polishing the interior diameters of cylinders, tubes and hydraulic fittings. Flaps adjust automatically to inside diameter, polishing the entire surface area with each pass.





Bore polishers are self-centering, so they apply equal pressure to full wall of inside diameter. Spring action design gives faster inside diameter cleaning, deburring and polishing to cylinders, deep bores and tubes.

Interleafed bore polishers are designed to polish and finish in one easy application. The abrasive flaps cut, while the non-woven flaps apply a fine finish.

GRIT RANGE: 60 - 240

ABRASIVE GRAIN: Aluminum Oxide

APPLICATION-TO-PRODUCT SHAPE RECOMMENDATION GUIDE

SHAPE	APPLICATION
 <p>Bore Polisher Solid Flaps B-3 Series</p>	<ul style="list-style-type: none"> • For 5/8" to 1" interior diameter bores • 3 abrasive packs 1-1/2" wide, bonded to hub • Use with QC-5 mandrel Part # 08834154182
 <p>Bore Polisher Solid Flaps B-4 Series</p>	<ul style="list-style-type: none"> • For 1" to 4" interior diameter bores • 4 abrasive packs 1-1/2" wide, bonded to hub • Use with BPM-4 mandrel Part # 08834154183
 <p>Bore Polisher Solid Flaps B-8 Series</p>	<ul style="list-style-type: none"> • For 2" to 5-7/8" interior diameter bores • 8 abrasive packs 1-1/2" wide, bonded to hub • Use with BPM-8 mandrel Part # 08834154184
 <p>Bore Polisher Scored Flaps</p>	Available upon request as made-to-order products
 <p>Bore Polisher Interleaf</p>	Cloth flaps are mixed with non-woven flaps. Merit interleaf bore polishers do double duty. Designed to polish and finish in one easy application, they are the ideal choice when close tolerances must be maintained, while giving an interior a polished finish.

APPLICATION/GRIT RECOMMENDATION GUIDE

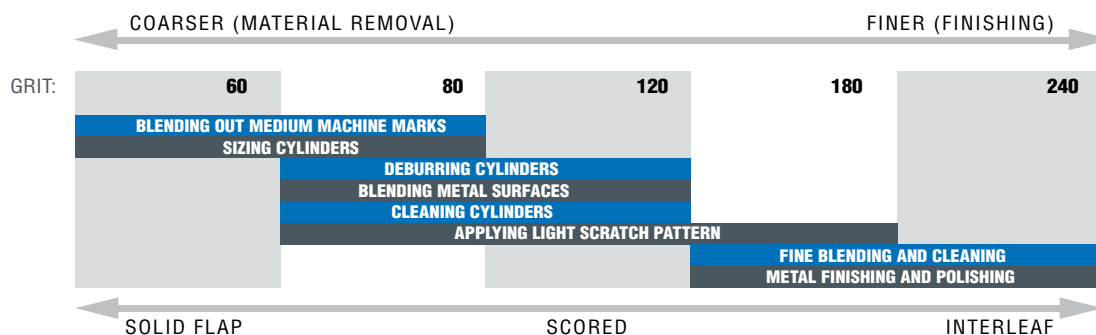



Merit Aluminum Oxide Bore Polishers

AVAILABILITY

TIER:	GOOD
BRAND:	Merit
ABRASIVE:	Aluminum Oxide
BACKING:	X-wt. Cotton/Poly

TIER:	GOOD
BRAND:	Merit
ABRASIVE:	Aluminum Oxide
BACKING:	X-wt. Cotton/Poly

DESCRIPTION	GRIT	MAX. RPM	STD. PKG.	PART #
Bore Polishers – Solid Flap B-3 and B-4 Series				
B-305	60	25,000	10	08834154190
Fits ID 5/8 to 1	80	25,000	10	08834154191
	120	25,000	10	08834154193
	180	25,000	10	08834154195
	240	25,000	10	08834154197
B-405	60	22,000	10	08834154091
Fits ID 1 to 1-1/2	80	22,000	10	08834154092
	120	22,000	10	08834154093
	180	22,000	10	08834154094
B-410	60	20,000	10	08834154100
Fits ID 1-1/2 to 2	80	20,000	10	08834154101
	120	20,000	10	08834154102
	180	20,000	10	08834154103
	240	20,000	10	08834154104
B-415	60	16,000	10	08834154109
Fits ID 2-1/8 to 2-1/2	80	16,000	10	08834154110
	120	16,000	10	08834154111
	180	16,000	10	08834154112
	240	16,000	10	08834154113
B-420	60	15,000	10	08834154118
Fits ID 2-1/2 to 3	80	15,000	10	08834154119
	120	15,000	10	08834154120
	180	15,000	10	08834154121
	240	15,000	10	08834154122
B-425	60	10,000	10	08834154127
Fits ID 3-1/8 to 4	80	10,000	10	08834154128
	120	10,000	10	08834154129
	180	10,000	10	08834154130
	240	10,000	10	08834154131

SOME MERIT PART NUMBERS ARE NON-STOCK. ASK YOUR NORTON/MERIT REPRESENTATIVE FOR STOCK/MTO STATUS.

DESCRIPTION	GRIT	MAX. RPM	STD. PKG.	PART #
Bore Polishers – Solid Flap B-8 Series				
B-810	60	16,000	10	08834154136
Fits ID 2 to 2-1/2	80	16,000	10	08834154137
	120	16,000	10	08834154138
	180	16,000	10	08834154139
	240	16,000	10	08834154140
B-815	60	15,000	10	08834154145
Fits ID 2-5/8 to 3	80	15,000	10	08834154146
	120	15,000	10	08834154147
	180	15,000	10	08834154148
	240	15,000	10	08834154149
B-820	60	10,000	10	08834154154
Fits ID 3-1/8 to 4	80	10,000	10	08834154155
	120	10,000	10	08834154156
	180	10,000	10	08834154157
	240	10,000	10	08834154158
B-825	60	8,000	10	08834154163
Fits ID 4-1/4 to 5-1/4	80	8,000	10	08834154164
	120	8,000	10	08834154165
	180	8,000	10	08834154166
	240	8,000	10	08834154167
B-830	60	8,000	10	08834154172
Fits ID 5-1/4 to 5-7/8	80	8,000	10	08834154173
	120	8,000	10	08834154174
	180	8,000	10	08834154175
	240	8,000	10	08834154176

Bore Polishers – Scored Flaps

Available on request as made-to-order products

Bore Polishers – Interleaf

B-405 Interleaf	80	22,000	10	08834150271
Fits ID 1 to 1-1/2	180	22,000	10	08834150273
B-410 Interleaf	80	20,000	10	08834150275
Fits ID 1-1/2 to 2				

Mandrels for Bore Polishers

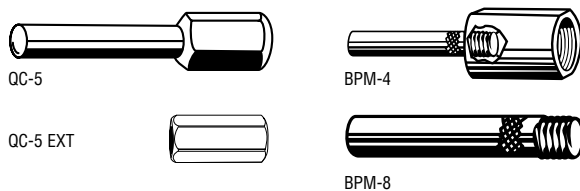

DESCRIPTION	MODEL NO.	THREAD	PART #
For B-3 Series	QC-5	5/16-18	08834154182
For B-4 Series	BPM-4	1/2-20	08834154183
For B-8 Series	BPM-8	1/4-20	08834154184
QC-5 Ext.	QC-5 Ext.	5/16-18	08834150573

STANDARD PACKAGE = 1

Extension Mandrels for Bore Polishers

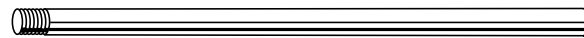

DIAMETER X LENGTH	MODEL NO.	THREAD	PART #
1/4 x 4	EM-144	1/4-20	08834154185
1/4 x 6	EM-146	1/4-20	08834154186
1/4 x 8	EM-148	1/4-20	08834154187

To extend a B-3 series bore polisher, attach the QC-5 Ext. to the bore polisher, then attach the desired length extension mandrel above to the QC-5 Ext. To extend a B-4 series bore polisher, attach the adapter piece of the BPM-4 mandrel to the bore polisher, then attach the desired length extension mandrel above to the BPM-4 adapter piece. To extend a B-8 series bore polisher, attach the desired length extension mandrel above directly to the bore polisher. Standard package = 1.

Test Kit

Merit Bore Polisher Test Kit "BP"

- Part # 08834154181
- Contains ten bore polishers and two mini 1/4"-20 thread flap wheels in assorted sizes and grits for finishing 1" to 5" interior diameters, and mandrel for 1/4" chuck.





CATEGORY DEFINITION

FlexDrum abrasive segments sweep away flaws. Their extreme longevity and perfect balance make them well-suited for automatic as well as offhand use. Hubs and abrasive segments can be combined to fit your job perfectly.

- APPLICATIONS: Blending out parting lines on castings, smoothing out pre-ground welded areas, removing burrs and work flaws, graining stainless, brush-finishing and satin-finishing aluminum, removing rust, deflashing molded plastic and rubber parts, and preparing surfaces for painting or plating.
- SIZE RANGE: Diameter of loaded FlexDrum: 8" – 18"
Width of FlexDrum: 1-1/2" – 12"
Custom die-cut segments as well as extra wide segments, in widths up to 144" are also available as made-to-order products.
- GRIT RANGE: 50 – 240
- BOND: Resin or glue
- BACKING: Heavyweight cotton
- ABRASIVE GRAIN: Premium Aluminum Oxide

SHAPE/APPLICATION RECOMMENDATION GUIDE



Plain Segment
 • For flat or mildly contoured surfaces



1/4 Scored (SC) Segment
 • Great for complex parts
 • Provides a fine finish



1/2 Slash (SL) Segment
 • Great for mild and moderate contours



Interleaf Segment
 • Available upon request as made-to-order product

LOADING FLEX DRUM HUBS



FlexDrum hub end plate removes for easy loading of abrasive segments.

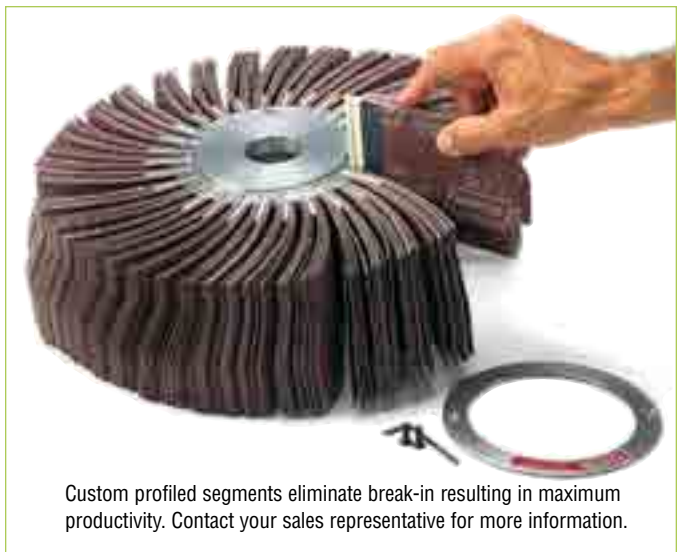

Custom profiled segments eliminate break-in resulting in maximum productivity. Contact your sales representative for more information.

Plain Segments – for flat or mildly curved surfaces

AVAILABILITY

		GOOD							
TIER:									
BRAND:		Merit	Merit	Merit	Merit	Merit	Merit	Merit	
ABRASIVE:		A/O	A/O	A/O	A/O	A/O	A/O	A/O	
GRIT:		50	60	80	100	120	180	240	
WIDTH	TRIM LENGTH*	STD. PKG.	PART #	PART #	PART #	PART #	PART #	PART #	
1-1/2	2-3/4	12	08834155002	08834155003	08834155004		08834155006	08834155008	08834155010
2	2-3/4	12	08834155013	08834155014	08834155015	08834155016	08834155017	08834155019	
2	4	20	08834155312	08834155313	08834155314	08834155315	08834155316	08834155318	
2	5	20		08834155568	08834155569		08834155571	08834155573	08834155575
3	2-3/4	12	08834155025	08834155026	08834155027	08834155028	08834155029	08834155031	
3	4	20	08834155324	08834155325	08834155326		08834155328	08834155330	
3	5	20		08834155579			08834155582	08834155584	
4	2-3/4	12	08834155036	08834155037	08834155038	08834155039	08834155040	08834155042	08834155044
4	4	20	08834155336	08834155337	08834155338		08834155340	08834155342	08834155344
4	5	20		08834155590			08834155593	08834150390	08834155953

ALL FLEXDRUM SEGMENTS ARE AVAILABLE AS NON-STOCK. ASK YOUR NORTON/MERIT REPRESENTATIVE FOR STOCK/MTO STATUS.

1/4 Scored Segments – for complex parts and provide a fine finish

AVAILABILITY

		GOOD								
TIER:										
BRAND:		Merit	Merit	Merit	Merit	Merit	Merit	Merit		
ABRASIVE:		A/O	A/O	A/O	A/O	A/O	A/O	A/O		
GRIT:		50	60	80	100	120	180	240		
WIDTH	TRIM LTH.*	SCORE	STD. PKG.	PART #	PART #	PART #	PART #	PART #	PART #	
1-1/2	2-3/4	1/4	12	08834155082	08834155083	08834155084	08834155085	08834155086	08834155088	08834155090
2	2-3/4	1/4	12	08834155094	08834155095	08834155096	08834155097	08834155098	08834155100	08834155102
3	2-3/4	1/4	12	08834155106	08834155107	08834155108	08834155109	08834155110	08834155112	
4	2-3/4	1/4	12	08834155117	08834155118	08834155119	08834155120	08834155121	08834155123	

ALL FLEXDRUM SEGMENTS ARE AVAILABLE AS NON-STOCK. ASK YOUR NORTON/MERIT REPRESENTATIVE FOR STOCK/MTO STATUS.

1/2 Slashed Segments – for mild and moderate contours

AVAILABILITY

		GOOD								
TIER:										
BRAND:		Merit	Merit	Merit	Merit	Merit	Merit	Merit		
ABRASIVE:		A/O	A/O	A/O	A/O	A/O	A/O	A/O		
GRIT:		50	60	80	100	120	180	240		
WIDTH	TRIM LTH.*	SLASH	STD. PKG.	PART #	PART #	PART #	PART #	PART #	PART #	
2	4	1/2	20		08834155420	08834155421	08834155422	08834155423	08834155425	08834155427
2	5	1/2	20			08834155637		08834155639		
3	4	1/2	20	08834155430	08834155431	08834155432	08834155433	08834155434	08834155436	08834155438
3	5	1/2	20			08834155648				
4	4	1/2	20	08834155443	08834155444	08834155445	08834155446	08834155447	08834155449	08834155451
4	5	1/2	20		08834155658	08834155659		08834155661	08834150383	

ALL FLEXDRUM SEGMENTS ARE AVAILABLE AS NON-STOCK. ASK YOUR NORTON/MERIT REPRESENTATIVE FOR STOCK/MTO STATUS.

*TRIM LENGTH IS THE ACTUAL USABLE LENGTH OF SEGMENT WHEN LOADED



FlexDrums can be used for polishing large IDs. Just load half the segments with a wheel diameter 1/2" to 1" larger than the ID of your workpiece.

Hub Units

- FlexDrum hubs are perfectly balanced, last indefinitely and are available in widths from 1-1/2" to 12"
- Extra wide widths are available up to 144" as made-to-order products

MODEL NO.	D x W	ARBOR HOLE/THREAD	SEGMENTS PER HUB	PART #
FlexDrum Hub Units				
81.5-B	2-3/8 x 1-1/2	1 AH	12	08834140065
82-B	2-3/8 x 2	1 AH	12	08834141049
		5/8-11 THD	12	08834140048
83-B	2-3/8 x 3	1 AH	12	08834141018
		5/8-11 THD	12	08834140034
84-B	2-3/8 x 4	1 AH	12	08834140066
		5/8-11 THD	12	08834140049
122-B	4 x 2	1-1/4 AH	20	08834140050
123-B	4 x 3	1-1/4 AH	20	08834140051
124-B	4 x 4	1-1/4 AH	20	08834140061
142-B	6 x 2	1-1/4 AH	30	08834140062
143-B	6 x 3	1-1/4 AH	30	69957399208
144-B	6 x 4	1-1/4 AH	30	08834141060
840-B2	8 x 2	1-1/4 AH	40	63642592550
840-B4	8 x 4	1-1/4 AH	40	63642592548



FlexDrum Reference Charts

FlexDrums can be mounted on any type of arbor.

Weights

DIAMETER	WEIGHT
Weight of Hubs*	
4" diameter hub	1.5 lbs./inch of width
6" diameter hub	2 lbs./inch of width
8" diameter hub	2.5 lbs./inch of width
Weight of Hubs with Segments*	
4" diameter hub	3.4 - 4 lbs./inch of width
6" diameter hub	5 - 5.5 lbs./inch of width
8" diameter hub	6.75 - 7 lbs./inch of width

*APPROXIMATE VALUES. ACTUAL WEIGHT WILL DEPEND ON ABRASIVE TYPE AND OVERALL WIDTH OF HUB.

FlexDrum Maximum RPM

WHEEL DIAMETER	MAXIMUM RPM
8	4,500
12	3,000
14	2,500
16	2,200
18	2,000

Recommended H.P. Required

HUB	H.P.
4" diameter hub	1/2 H.P./inch of width
6" diameter hub	3/4 H.P./inch of width
8" diameter hub	1 H.P./inch of width

Recommended Surface Feet per Minute for using FlexDrum Wheels on Various Materials

MATERIAL	SFPM
Mild Steel	5,000
Stainless Steel	6,500
Alloy Steel	5,000
Titanium	3,500
Hard Aluminum	5,500
Nonferrous	5,000
Rubber	4,500
Hardwood (edge breaking)	4,000
Softwood	3,500
Thermoplastic	3,000



FlexDrum Hub Specification Chart

	82-B	121-B	141-B	840-B
Diameter of Finished Wheel	8	12	14 or 16	16 or 18
Diameter of Hub Alone	2-3/8	4	6	8
Arbor Hole	1 or 5/8-11 thd	3/4 to 1-3/4	1 to 3-1/2	1-1/4 to 5
Segments Per Hub	12	20	30	40

How to Determine Diameter of Finished FlexDrums

HUB DIAMETER	TRIM LENGTH (X2)	FINISHED WHEEL
2-3/8	2-3/4	8
4	4	12
4	5	14
6	4	14
6	5	16
8	4	16
8	5	18

TECHtip

For surface feet per minute, use the following calculation: SFPM=.262 x DIA (in inches) x RPM.

Coated Abrasives

A coated abrasive product is made up of three basic raw materials: an abrasive mineral, the backing onto which the abrasive is applied, and an adhesive bond.

Abrasive Types

Emery (6)

Emery is a dark gray, round-shaped grain which tends to polish rather than abrade a work surface.

- For polishing and cleaning metal only

Garnet (5)

Garnet is reddish brown in color. This natural abrasive is medium hard and relatively sharp, but not as durable as synthetic abrasives.

- For use on wood only
- Particularly good for soft woods such as pine
- Produces an excellent finish

Silicon Carbide (4)

Silicon carbide is the hardest and sharpest of the manufactured abrasives. Because of its extreme sharpness, this bluish-black abrasive grain permits fast stock removal and cool cut.

- Cast iron
- Non-ferrous metals, i.e. brass, aluminum and bronze
- Non-metallics, i.e. glass, rubber, plastic and stone
- Final finish on wood and stainless steel
- Abrasive planing particleboard

Light Brown Aluminum Oxide (2)

Light brown aluminum oxide is a tough, yet sharp synthetic abrasive characterized by cool cut, long life and the ability to break down under pressure, producing new cutting edges.

- Production wood sanding
- Non-ferrous metal finishing

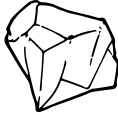

Brown Aluminum Oxide (2)

Brown aluminum oxide is a tough, durable, synthetic abrasive characterized by the long life and wear resistance of its cutting edges. It offers enormous penetrating strength, even at high speeds.

- Ferrous metals
- Aluminum
- Hardwood



Heat-treated Aluminum Oxide (2)

Heat-treated aluminum oxide is a tough but cool cutting abrasive which gives both long life and freeness of cut on a wide range of materials.

- Ferrous metals
- Wood sanding



Zirconia Alumina (8)

Zirconia alumina is an ultra-tough, synthetic abrasive which provides a free, cool cut for high stock removal applications. It is tougher and sharper than aluminum oxide. It has a micro-crystalline structure which allows for controlled breakdown and self-sharpening.

- Heavy-duty snagging and grinding of all ferrous and non-ferrous metals
- Abrasive planing of wood, plywood and particleboard
- Grinding fiberglass, rubber and plastics



Ceramic Alumina (9)

The sub-micron structure of ceramic alumina allows each grain to continually expose sharp cutting points, resulting in a cooler cutting action and an extended life.

- All ferrous/non-ferrous metals, carbon steel and exotic alloys

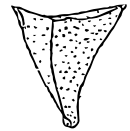

Backing Types

Backings are the base for the abrasive minerals and, combined with the adhesive bond, support and anchor the abrasive mineral. The backings used in the manufacture of coated abrasives are:

Paper

Due to the fine surface of paper, a consistent finish is produced. Paper weights include *A, B, C, D, E* and *F* weights with *A* being the lightest and most flexible and *F* being the heaviest and least flexible. *A, B, C* and *D* weight papers are used for hand sanding and light mechanical operations in the form of sheets, PSA (pressure sensitive adhesive) and hook and loop discs and sheet rolls. *E* and *F* weight papers are primarily used for more aggressive mechanical operations in the form of belts and discs.

Cloth

Cloth backings used for coated abrasives are identified by weight. Cloth backings are filled or "finished" with a variety of materials (glues or resins) to create various backing characteristics, most notably flexibility. Several cloth types are used: cotton, polyester, polyester/nylon and polyester/cotton blends, and rayon.

There are three basic weights of cloth: *J*-weight or "jeans" is the lightest and most flexible. *X*-weight or "drills" is a heavier cloth that ranges in flexibility, strength and durability and is used on the broadest range of applications. *Y*-weight is a heavyweight drills cloth used on heavy-duty, high stock removal operations.

Fiber

Vulcanized fiber (cotton fibers which are chemically treated and then pressed under temperature and pressure to form a very durable backing) is used exclusively as the backing for resin fiber discs.

Film

Polyester film backing comes in 3 mil. and 5 mil. thicknesses, which have high strength and surface smoothness. They are used primarily in disc and roll applications requiring consistent surface finish.

Bond Types

An adhesive bond system is required to secure the abrasive mineral to the backing. All coated abrasive products are made with a two stage bonding process, the *make coat* and the *size coat*.

The *make coat* is the first layer of bond applied to the backing. The *make coat* provides the adhesive base between the abrasive mineral and the backing.

The *size coat* is the second coat, which is applied over the abrasive mineral and *make coat* to anchor the abrasive mineral and provide the desired physical strength of the finished product.

Glue, urea resin, and phenolic resin are the three basic bonding agents most commonly used. There are many *size coat* and *make coat* combinations, such as *glue over glue, urea over glue, and resin over resin*. *Glue over glue* is the most flexible bond while *resin over resin bond* is moisture-resistant, harder, less flexible, heat-resistant and has superior grain retention.

Coating Types

There are two types of abrasive coatings used in the manufacturing of coated abrasives: *open coat* and *closed coat*.

Open Coat

With an open coat, 50% to 75% of the surface is covered by abrasive grain. There are evenly spaced voids between the particles of grain, helping reduce the effect of loading caused by wood dust or metal particles.



OPEN COAT
(1/3 LESS GRAIN THAN CLOSED)

Closed Coat

With a closed coat, the entire surface is covered with abrasive grain, with no voids between the particles. This is the most typical coating, permitting the greatest degree of stock removal and longest product life.



CLOSED COAT

How to Read a Coated Abrasive Specification

The Norton coated abrasive marking system includes both a generic and a technical marking, which identifies the actual components which make up the product. The markings identify the tradename, abrasive type, bond, backing, and any special features. An example would be: Norton Blaze R980P.

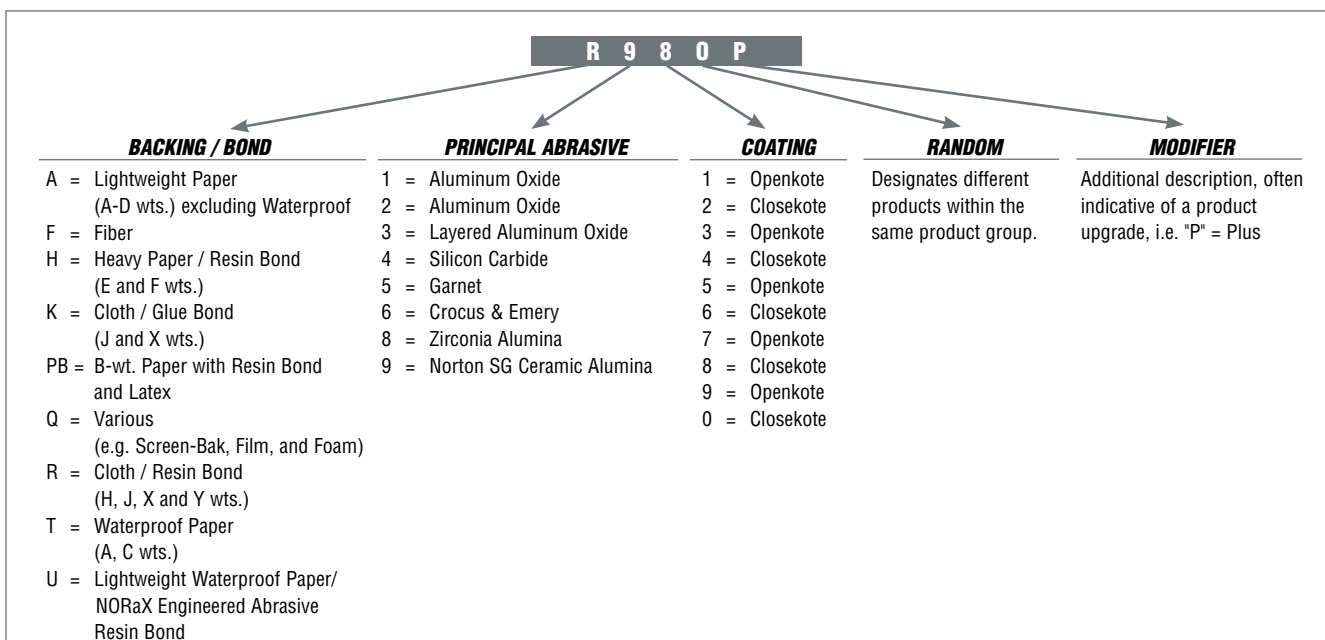

Coated Abrasive Grit Comparison Chart

AVERAGE PARTICLE SIZE IN MICRONS	GRADING SYSTEMS (OTHER THAN EMERY)			EMERY
	CAMI	FEPA	JIS	PRODUCTS
5.0	—	—	—	—
6.0	—	—	3000	—
6.5	1200	—	2500	4/0
8.4	—	P2500	—	—
8.5	—	—	2000	—
9.2	1000	—	—	3/0
10.3	—	P2000	—	—
10.5	—	—	1500	—
12.2	800	—	1200	—
12.6	—	P1500	—	—
15.0	—	—	—	—
15.3	—	P1200	1000	—
16.0	600	—	—	2/0
18.3	—	P1000	800	—
19.7	500	—	—	0
20.0	—	—	—	—
21.8	—	P800	—	—
23.6	400	—	600	—
25.0	—	—	—	—
25.75	—	P600	—	—
28.8	360	—	500	—
30.0	—	P500	—	—
35.0	—	P400	400	—
36.0	320	—	—	—
40.0	—	—	360	—
40.5	—	P360	—	—
44.0	280	—	—	1
45.0	—	—	—	—
46.2	—	P320	320	—
50.0	—	—	—	—
52.5	—	P280	280	—
53.5	240	—	—	—
55.0	—	—	—	—
58.5	—	P240	—	—
60.0	—	—	240	—
64.0	—	—	—	2
65.0	—	P220	220	—
66.0	220	—	—	—
78.0	180	P180	180	—
79.0	—	—	—	3
93.0	150	—	150	—
95.0	—	—	—	FINE
97.0	—	P150	—	—
116.0	120	—	120	—
127.0	—	P120	100	—
136.0	—	—	—	MEDIUM
141.0	100	—	—	—
156.0	—	P100	—	—
189.0	—	—	—	COARSE
192.0	80	—	80	—
197.0	—	P80	—	—
260.0	—	P60	—	—
268.0	60	—	60	—
326.0	—	P50	50	—
341.0	—	—	—	EX. COARSE
351.0	50	—	—	—
412.0	—	P40	40	—
428.0	40	—	—	—
524.0	—	P36	—	—
535.0	36	—	36	—
622.0	—	P30	—	—
638.0	30	—	30	—
715.0	24	—	—	—
740.0	—	P24	24	—
905.0	20	—	—	—
984.0	—	P20	20	—
1320.0	16	—	16	—
1324.0	—	P16	—	—
1764.0	—	P12	—	—
1842.0	12	—	—	—

Coated Abrasive Storage

Stored under proper conditions, coated abrasives will retain their efficiency and usefulness over long periods. Improper or inadequate storage can introduce problems of weakened bond, curl, brittleness, and breakage.

Temperature and humidity are the two most important climatic factors influencing coated abrasive performance. Backings and adhesives are sensitive to climatic changes and will gain or lose moisture according to the relative humidity of their surroundings.

Excessive humidity may cause a softening of some types of adhesive bonds so that the product quickly fills and clogs, or loses its grain during use. Excessive dryness may cause brittleness, reduced flexibility, and distortion of product shapes.

As moisture in the coated abrasive product increases or decreases, dimensional changes can occur. When the backing changes more than the adhesive bond, it causes cupping. High and low humidity can cause concave and convex cupping respectively.

The newer synthetic-backed belts are not affected by moisture. Broad temperature swings will not permanently harm these products either, but cold temperatures will cause a "cold set" condition. Consequently, these products should be allowed to come to room temperature before use.

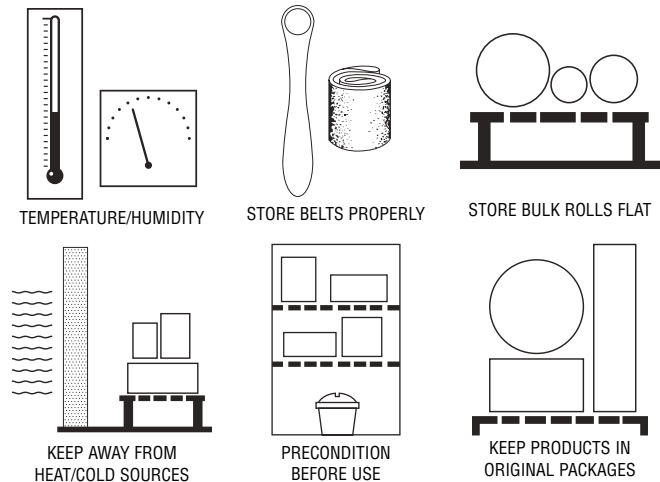

Storage Facilities

The ideal storage (stock) room for coated abrasives would be one in which all the walls are inside partitions, rather than the outside walls of the building.

- Constant levels of humidity and temperature should be maintained. Stockroom temperature should be 60-degrees to 80-degrees F and relative humidity between 35 and 50%.
- Cartons should be kept away from damp or cold walls and floors, where they may absorb moisture.
- Store coated abrasives away from heat sources – steam heated radiators, steam pipes, hot air inlets, heat ducts, or rooms near furnaces or ovens.
- Keep products in original packages. These packages facilitate handling and may be stacked in the most practical and convenient manner.
- Bulk rolls should not be allowed to stand on edge after they have been unpacked. Store flat on shelves or pallets.
- Narrow belts which have been removed from the carton should be rolled up and stored on edge on a clean shelf. Belts may be draped over a large cylinder, such as a gallon can, brake drum, or flanged hanger of the type used for a garden hose. Never hang a belt from a nail – the backing will crease and the abrasive may crack. Wide belts should be hung over a tube of at least 4" diameter. Center the belt joint over the tube and add a light weight (such as old packaging tubes) to the bottom loop of the belt to aid in removing set. Condition for 24 hours prior to use.
- For maximum product efficiency, precondition coated abrasive products in a chamber of controlled temperature and humidity before use.



we've surfaced faster solutions **THAT WORK HARD AND PAY BETTER**

For stripping, deburring, finishing, blending or polishing surfaces and coatings, Norton Bear-Tex non-woven innovations reduce steps and improve surface finish.

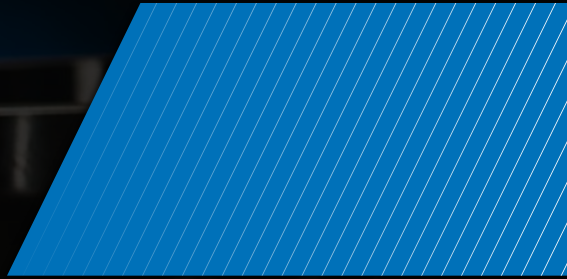

Our patented Clean Bond Technology eliminates smearing.



Strip Away Old Ideas

Quick and easy rough cleaning and stripping of scale and heavy stock on a variety of materials while maintaining its non-loading feature.



Prep for the Future

Cleaning and surface conditioning Norton Rapid Prep products deliver higher material removal, longer life and consistent, smear-free finishes - even on high nickel content alloys



Blending In is Easy

Polishing and finishing with Norton Rapid Blend discs leaves a smear-free final finish in fewer steps.



CATEGORY DEFINITION

Non-woven depressed center discs have three components: strong synthetic fiber mesh and quality abrasives, bonded together by a smear-resistant adhesive. Rapid Strip discs have an open web construction that enables aggressive cutting action while maintaining a cool, non-loading surface. Rapid Blend discs have a unitized construction with varying weave – from open to tighter – for deburring and finishing. Rapid Prep discs have a more open weave that excels in preparation and cleaning of a surface. Each product provides excellent cutting action while improving surface finish.

- APPLICATIONS:** Medium-to-light material removal, deburring, blending, cleaning, finishing, and polishing
- SIZE RANGE:** 4-1/2" - 7"
- GRIT RANGE:** X-Coarse, Coarse, Medium, Fine, Very Fine
- ABRASIVE GRAIN:** Ceramic Alumina, Silicon Carbide, Aluminum Oxide

WHY CHOOSE NON-WOVEN DEPRESSED CENTER DISCS?

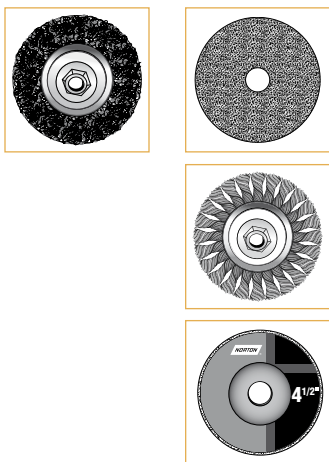

Non-Woven Right Angle Discs vs. Fiber Discs, Wire Wheels, and Depressed Center Wheels

- Deburring, blending and finishing done with one product to reduce the number of steps
- To provide a controlled, sustained finish
- To prevent undercutting and gouging
- To provide a cooler grinding action to lessen the chance of warping or discoloration
- When loading is an issue with fiberglass, adhesives and soft metals
- For stripping coatings and paint off of hard materials like concrete, cement and stone
- Less vibration and quieter for high operator acceptance
- To provide an alternative to wire brushes

MATERIAL/APPLICATION-TO-PRODUCT RECOMMENDATION GUIDE

	BEST Highest Productivity. Lowest Total Cost.	BETTER Excellent Blend of Performance & Price.	GOOD Consistent Performance. Low Initial Price.
Removing scale and coarse welding marks	Blaze Rapid Strip Ceramic X/Coarse	–	Rapid Strip S/C X-Coarse
Removing coatings, epoxy/glue, paint and other clogging material			
Removing rust, oxidation, corrosion and residue			
Removing parting lines and seams on fiberglass parts			
Removing paint/graffiti from concrete/stone			
Removing weld marks and weld splatter	–	Vortex Rapid Blend A/O Coarse	Rapid Blend A/O Coarse
Stainless steel deburring and cleaning			
Removing small flashings and parting lines			
Surface preparation before coatings/plating	–	Vortex Rapid Prep A/O Medium	Rapid Prep A/O Medium
Light cleaning			
Cleaning and prepping welds	–	Vortex Rapid Prep A/O Fine	Rapid Prep A/O Fine
Removing blemishes after welding stainless			
Blending and finishing all metal parts	–	Vortex Rapid Blend A/O Very Fine	Rapid Blend S/C Very Fine
Creating decorative finishes on stainless steel			
Final finishing and polishing			
Final finishing/polishing where high conformability is needed	–	–	Rapid Prep A/O Very Fine



APPLICATION/PRODUCT RECOMMENDATION GUIDE

	← MOST AGGRESSIVE / LEAST CONFORMABLE		LEAST AGGRESSIVE / MOST CONFORMABLE →		
DEPRESSED CENTER DISCS WITH BACK-UP PAD	BLAZE RAPID STRIP	VORTEX RAPID BLEND A/O MED. RAPID BLEND A/O COARSE	RAPID BLEND A/O MEDIUM	RAPID BLEND S/C FINE	RAPID PREP VERY FINE
		RAPID PREP A/O COARSE	RAPID PREP A/O MEDIUM	RAPID PREP A/O FINE	
SCALE REMOVAL	BEST CHOICE				
STOCK REMOVAL	BEST CHOICE	SECOND CHOICE			
HEAVY DEBURRING	SECOND CHOICE	BEST CHOICE			
LIGHT DEBURRING		BEST CHOICE	SECOND CHOICE		
LIGHT FINISHING		SECOND CHOICE	BEST CHOICE		
BLENDING			BEST CHOICE	SECOND CHOICE	
FINISHING			SECOND CHOICE	BEST CHOICE	
POLISHING				BEST CHOICE	SECOND CHOICE

CROSS REFERENCE GUIDE

	STRIPPING EXTRA COARSE		SURFACE FINISHING COARSE – MEDIUM – FINE			SURFACE PREP VERY FINE
	BEST Blaze Rapid Strip	GOOD Rapid Strip	BETTER Vortex Rapid Blend	GOOD Rapid Blend	BETTER Vortex Rapid Prep	GOOD Rapid Prep
NORTON 3M	–	Clean & Strip	–	–	–	SL Surface Conditioning
Bibielle	–	SDR Strip-It/Red	–	Unitized	–	–
Camel	–	EZ Strip Black/Red	–	–	–	–
Flexovit	–	Clean & Strip	–	–	–	–
Hermes	–	Webrax	–	–	–	–
Pearl	–	S/C Stripping	–	–	–	Surface Preparation
Pferd	–	Policlean	–	Poliflex PUR	–	–
Sait	–	Sait-Strip	–	Unitized	–	–
Standard	–	Cleaning	–	Unitized	–	–
Superior	–	Stripping	–	Unitized	–	–
Walter	–	FX Cleaning	–	–	–	Blendex Surface Conditioning



Norton Blaze Rapid Strip Type 27 Depressed Center Discs

Strip/blend cast iron, steels, aluminum, fiberglass and composites

- Open structure; will not load on sticky coatings, adhesives, and soft metals (e.g. aluminum), or snag and shed like a cloth or fiber disc
- Norton Blaze ceramic alumina grain provides 2X cut rate and life over silicon carbide
- Will not shed on heavily rust-encrusted pieces
- Extremely versatile; use one disc; stiff enough to stand abuse, but soft enough to prevent gouging and rework
- Use on edge for blending weld root forms
- Apply some pressure to strip or remove coatings; lighter pressure finishes like a surface finishing disc
- Fewer safety, ergonomic, and environmental issues due to fewer change-outs, less downtime, and less production waste/landfill scrap

FEATURED PRODUCTS



NORTON BLAZE RAPID STRIP NON-WOVEN DEPRESSED CENTER DISCS – TYPE 27
BEST CHOICE FOR QUICK AND EASY ROUGH CLEANING AND STRIPPING OF ALL MATERIALS

FEATURES	BENEFITS
■ Blaze ceramic alumina grain	■ 2x cut rate, 2x life over silicon carbide products
■ Advanced resin bond	■ Does not shed on rust-encrusted pieces, and prevents gouging and rework
	■ Does not snag when used for deburring
■ Uniform coating process	■ Abrasive coating covers the entire disc providing a consistent cut rate
■ Open structure	■ Sticky coating, adhesives and soft metals will not clog the disc

AVAILABILITY

TIER:	BEST	GOOD
BRAND:	Norton	Norton
TRADENAME:	BLAZE RAPID STRIP	RAPID STRIP
ABRASIVE:	Ceramic Alumina	Silicon Carbide
GRIT SIZE:	36-50	36-50
GRADE:	X-Coarse	X-Coarse
TYPE/BACKING:	Type 27/Fiberglass	Type 27/Fiberglass

SIZE (D x H)	MAX. RPM	STD. PKG.	PART #	PART #
4-1/2 x 5/8-11	12,000	10	66254498101	66261009585
4-1/2 x 7/8	12,000	10	66623303783	66261009649
5 x 5/8-11	11,000	10	66623303915	
5 x 7/8	11,000	10	66623303916	
7 x 5/8-11	8,000	10	66623303919	66261009650
7 x 7/8	8,000	10	66623303920	66261009586



NORTON VORTEX RAPID BLEND DEPRESSED CENTER DISCS – TYPE 27
REVOLUTIONARY TECHNOLOGY FOR HEAVY DEBURRING AND FINISHING

FEATURES	BENEFITS
■ Proprietary high-performance, engineered aluminum oxide aggregate grain	■ Aggressive, fast stock removal cut rate while providing a fine finish
	■ Twice the wheel life over conventional unified wheels, with minimal shedding
■ New bond technology	■ Consistent performance with no smearing
■ Controlled porosity	■ Cooler and improved cut rate

AVAILABILITY

TIER:	BETTER	GOOD	GOOD	GOOD	GOOD
BRAND:	Norton	Norton	Norton	Norton	Norton
TRADENAME:	VORTEX RAPID BLEND	RAPID BLEND	RAPID BLEND	RAPID BLEND	RAPID BLEND
ABRASIVE:	Engineered A/O	Aluminum Oxide	Aluminum Oxide	Silicon Carbide	Aluminum Oxide
GRIT SIZE:	100-120	150-180	220-280	320-400	150-180
SPECIFICATION:	Medium	NEX-2AM	NEX-2AF	NEX-2SVF	High Strength Medium
TYPE/BACKING:	Type 27/Fiberglass	Type 27/Fiberglass	Type 27/Fiberglass	Type 27/Fiberglass	Type 27/Fiberglass
SIZE (D x H)	MAX. RPM	STD. PKG.	PART #	PART #	PART #
4-1/2 x 5/8-11	12,000	10	66254429243	66261023947	66261023946
4-1/2 x 7/8	12,000	10	66254429268	66261020548	66261020547





FEATURED PRODUCTS



NORTON VORTEX RAPID PREP NON-WOVEN DISCS
BETTER CHOICE FOR FINISHING AND BLENDING APPLICATIONS

FEATURES

- Proprietary, engineered Vortex aluminum oxide abrasive grain, new coating method, and smear-free Clean-Bond technology

BENEFITS

- Most consistent cutting and finishing surface conditioning products on the market
- Combine maximum cutting speed with the finish of fine grits
- Reduce process times by 50+% by eliminating 2 to 5 grit sequences to 1 step in your technical blending operations
- More resistant to edge wear; up 4X life vs. competitive products
- Friable grain structure keeps Ra specs throughout disc life and reduces scrap and rework

**7/8" Center Hole
AVAILABILITY**

		TIER:	BETTER	GOOD
		BRAND:	Norton	Norton
		TRADENAME:	VORTEX RAPID PREP	RAPID PREP
		ABRASIVE:	Aluminum Oxide	Aluminum Oxide
SIZE (DIAMETER)	STD. PKG.		PART #	PART #
EXTRA COARSE				
4-1/2	25		66623334973	66623326070
5	25		66623334975	66261090645
6	25		66623341359	66623326076
7	25		66623341360	66623326085
COARSE				
4-1/2	25		66623334944	66254473868
5	25		66623334946	66261008293
6	25		66623341361	66623325136
7	25		66623341362	66623325138
MEDIUM				
4-1/2	25		66623333612	66623325915
5	25		66623334963	66261017124
6	25		66623341363	66623325918
7	25		66623341364	66623325919
FINE				
4-1/2	25		66623333608	66623325153
5	25		66623334954	66254469132
6	25		66623341365	66623325159
7	25		66623341366	66623325897
VERY FINE				
4-1/2	25		66623333616	66623325938
5	25		66623333618	66623325943
6	25		66623341367	66623325958
7	25		66623341368	66623325959



DESCRIPTION	MAX. RPM	STD. PKG.	PART NO.
Rapid Prep Disc Back-up Pads			
4-1/2" Medium	11,000	5	63642502122
5" Medium	10,000	5	63642543421
7" Medium	8,600	5	63642543422



Norton Rapid Prep Surface Conditioning Products

The Perfect Abrasive, Coating, and Bond Built into Every Disc and Belt

- Available in premium Vortex aluminum oxide aggregate grain and Norton aluminum oxide grain ideal for many aerospace, metal and stainless steel fabrication, and MRO applications
- Our proprietary coating method extends life and delivers consistent finishes by creating a thick layer of grain throughout the product. Grain does not sit on top of fibers as other competitive products can.
- Our new Clean Bond resin system guarantees smear-free finishes, even on high nickel content alloys; will not load on aluminum and soft metals, as competitive products can

FEATURED PRODUCTS



AVOS RAPID PREP SPEED-LOK DISCS

GOOD CHOICE FOR LIGHT DEBURRING, CLEANING AND FINISHING

FEATURES	BENEFITS
<ul style="list-style-type: none"> Patented hole design 	<ul style="list-style-type: none"> Allows interrupted cut, reducing heat up to 30% over standard surface preparation discs Cool cutting results in longer disc life Provides complete vision into the grinding zone Operators can grind more accurately with less re-work
<ul style="list-style-type: none"> Scooped holes 	<ul style="list-style-type: none"> Create air flow to pull loose abrasive and swarf away from work surface grinding zone – resulting in extended disc life
<ul style="list-style-type: none"> 15 degree angle back-up pad 	<ul style="list-style-type: none"> Grinding at 5°-15° angle allows greater utilization of disc surface Eliminates gouging of workpiece

AVOS Speed-Lok AVAILABILITY

		TIER: BETTER	GOOD
		BRAND: Norton	Norton
		TRADENAME: VORTEX RAPID PREP	RAPID PREP
		ABRASIVE: Aluminum Oxide	Aluminum Oxide
SIZE (DIAMETER)	STD. PKG.	PART #	PART #
EXTRA COARSE			
4-1/2	10	66623374800	66623374815
5	10	66623374801	66623374816
7	10	66623374802	66623374817
COARSE			
4-1/2	10	66623374803	66261010447
5	10	66623374804	66623374818
7	10	66623374805	
MEDIUM			
4-1/2	10	66623374806	66261010448
5	10	66623374807	66623374819
7	10	66623374808	
FINE			
4-1/2	10	66623374809	66623374820
5	10	66623374810	66623374821
7	10	66623374811	66623374822
VERY FINE			
4-1/2	10	66623374812	66623374823
5	10	66623374813	66623374824
7	10	66623374814	



DESCRIPTION	MAX. RPM	STD. PKG.	PART #
AVOS Speed-Lok Back-up Pads – Triangular			
4-1/2 x 5/8-11	13,000	5	63642502985
5 x 3/8-24 Pistol Grip*	20,000	5	63642503029
5 x 5/8-11 Thicker	13,000	5	63642502517
5 x 5/8-11	13,000	5	63642503663
5 x 7/16-20 Pistol Grip*	20,000	5	63642503030
AVOS Speed-Lok Back-up Pads – Round			
7 x 5/8-11 Hard	8,600	5	63642504873
7 x 5/8-11 Medium	8,600	5	63642504874

* USE ON AIR PNEUMATIC AND HIGH-SPEED PISTOL GRIP SANDERS.

Speed Change 5/8"-11 AVAILABILITY

		TIER: BETTER	GOOD
		BRAND: Norton	Norton
		TRADENAME: VORTEX RAPID PREP	RAPID PREP
		ABRASIVE: Aluminum Oxide	Aluminum Oxide
SIZE (DIAMETER)	STD. PKG.	PART #	PART #
EXTRA COARSE			
4-1/2	25	66623373667	66623373690
5	25	66623373669	66623373691
7	25	66623373670	66623373692
COARSE			
4-1/2	25	66623373671	66623373693
5	25	66623373674	66254498516
7	25	66623373675	66261192908
MEDIUM			
4-1/2	25	66623373678	66623308157
5	25	66623373679	66623373694
7	25	66623373680	66261192913
FINE			
4-1/2	25	66623373681	66623373696
5	25	66623373682	66623373695
7	25	66623373684	66623373697
VERY FINE			
4-1/2	25	66623373685	66623373698
5	25	66623373686	66623373699
7	25	66623373687	66623373700



DESCRIPTION	MAX. RPM	STD. PKG.	PART #
Smooth-Face Back-up Pads for 5/8-11 Speed-Change Discs			
4-1/2" Medium	20,000	5	66254492277
5" Medium	12,000	5	63642543235
7" Hard	8,600	5	63642543240
7" Medium	8,600	5	63642543245
7" Soft	8,600	5	63642543250
9" Medium	7,000	5	63642543270



CATEGORY DEFINITION

Norton and Merit non-woven quick-change discs are a combination of strong synthetic mesh and quality abrasives, bonded together by a smear-resistant adhesive. They are ideal for use on portable tools to clean and remove imperfections on metal surfaces, clean, deburr or finish a variety of surfaces, blend weld seams, or create decorative finishes. The open construction of the non-woven material enables aggressive cutting action and improved surface finish while maintaining its non-loading feature.

- APPLICATIONS:** Medium-light stock removal, beveling, deburring/deflashing, rust removal, blending, cleaning and finishing, polishing
- SURFACE FINISHING MATERIALS:** Surface stripping, surface deburring and blending, surface preparation, buffing, and polishing
- SIZE RANGE:** 3/4" – 8" diameter
- GRIT RANGE:** X-Coarse, Coarse, Medium, Fine, Very Fine, Super Fine
- ABRASIVE GRAIN:** Ceramic Alumina, Aluminum Oxide, Silicon Carbide
- ATTACHMENT:** Quick-Change Type TR (Type III), Type TS (Type II), and Type TP (Type I)
- BACK-UP PADS:** Rubber with hardness variations for different applications

QUICK-CHANGE ATTACHMENT SYSTEMS AND CROSS REFERENCE GUIDE

Each system enables quick, safe disc changes, reducing downtime and operating expenses.

Type TS (Type II)

- Features a turn-on/turn-off style fastener
- Fastener is made of metal
- Equivalent to Standard Abrasives SocAtt® locking system



Type TR (Type III)

- Features a roll-on/roll-off style fastener
- Fastener is made of plastic
- Equivalent to 3M™ Roloc™ fastening system



Type TP (Type I)

- Features a snap-on/snap-off style fastener
- Fastener is made of nylon



NORTON

TS

TR

TP

3M	Roloc TS/TSM	Roloc TR	Roloc TP
Standard	TS (SocAtt)	TR (Lockit)	TP (ClickOn)
Superior	Type S	Type R	–
Arc	Type S	Type R	Type P
Pferd	Type CD	Type CDR	–
Sait	SAIT-LOK	SAIT-LOK-R	–
Camel	Turn On	Roll On	–
Klingspor	QMC	QRC	–
Garryson	Type S	Type R	–

APPLICATION/GRIT RECOMMENDATION GUIDE

	← MOST AGGRESSIVE				→ LEAST AGGRESSIVE	
NORTON	RAPID STRIP	VORTEX RAPID BLEND	VORTEX RAPID PREP	RAPID PREP		
MERIT	DEBURRING & BLENDING			HS BUFFING, BUFFING		
SCALE REMOVAL	BEST CHOICE					
STOCK REMOVAL	BEST CHOICE	SECOND CHOICE				
HEAVY DEBURRING	SECOND CHOICE	BEST CHOICE				
LIGHT DEBURRING	BEST CHOICE		SECOND CHOICE			
LIGHT FINISHING				BEST CHOICE	SECOND CHOICE	
BLENDING				BEST CHOICE	SECOND CHOICE	
CLEANING			SECOND CHOICE	BEST CHOICE		
FINISHING					BEST CHOICE	SECOND CHOICE



CROSS REFERENCE GUIDE

	STRIPPING		HEAVY/LIGHT DEBURRING		LIGHT DEBURRING/BLENDING/CLEANING/FINISHING		
	BEST	GOOD	BETTER	GOOD	BETTER	GOOD	GOOD
NORTON	Blaze Rapid Strip	Rapid Strip	Vortex Rapid Blend	Rapid Blend	Vortex Rapid Prep	Rapid Prep	
MERIT				Deburring & Blending			HS Buffing, Buffing
3M	-	Clean & Strip Clean Strip XT	-	EXL Unitized	-	Surf Cond, SL, SE	-
Standard	-	Cleaning Disc	-	500-900 Series Unitized	-	FE, GP, RC	Buff & Blend - HS, Buff & Blend
Fiberal/SIA	-		-	-	-	Meteor, Type B & C	-
Superior	-	Type R	-	XL Unitized	-	FD, GD, CC	HS, HD A/O
Arc	-	Arcstrip	-	-	-	Surface Cond	Blend & Finish
Pferd	-	Policlean	-	-	-	Finishing Disc - Hard & Soft	-
Sait	-	SAIT-Strip	-	-	-	HD, GP	Sand-Light Blending
Camel	-	EZ Strip - Black	-	-	-	-	-
Klingspor	-	Strip-It Black	-	-	-	-	-
Garryson	-		-	-	-	Surface Cond	-
Bibielle	-		-	BUR Unitized	-	DCR	-

ABRASIVE/GRIT/DENSITY KEY

ABRASIVE	SILICON CARBIDE			ALUMINUM OXIDE		CERAMIC ALUMINA
	SHARPER, FINER/BRIGHTER SCRATCH PATTERN			MORE DURABLE, LONGER LASTING, POLISHED FINISH		
GRIT SIZE	XC (24-36)	C (50-80)	M (100-150)	F (180-220)	VF (240-360)	SF (400-600)
	FASTER, AGGRESSIVE CUT, ROUGHER FINISH			REDUCED CUT RATE, FINER FINISH		
DENSITY	2			9		
	SOFT, OPEN, CONFORMABLE, LESS BURNING/LOADING			HARDER, MORE DURABLE, FASTER CUTTING, BETTER FINISH		

FEATURED PRODUCTS

Quick-Change Rapid Strip Discs



NORTON BLAZE RAPID STRIP AND NORTON RAPID STRIP DISCS

IDEAL FOR REMOVING COATINGS ON A VARIETY OF SUBSTRATES, SUCH AS WOOD, METAL AND PLASTICS

FEATURES BENEFITS

- Manufactured with extruded nylon fibers, flexible resin technology, and extra-coarse abrasive grains
- Blaze Rapid Strip
- Provide a unique combination of aggressive performance, long life, improved finish
- Outperform traditional coated abrasive products, leaving a thoroughly cleaned surface, ensuring excellent adhesion in subsequent processes such as coating, painting and soldering
- Great alternative to wire brushes
- Will not load on sticky coatings, adhesives, and soft metals, or snag and shed like a fiber disc
- 2X faster cutting than competitive discs; lasts 2X (plus) as long
- Stiff enough to stand abuse; soft enough to prevent gouging and rework. Apply some pressure to strip/remove coatings; lighter pressure finishes like a surface finishing disc

AVAILABILITY

TIER:	BEST	GOOD	GOOD
BRAND:	Norton	Norton	Norton
TRADENAME:	BLAZE RAPID STRIP	RAPID STRIP	RAPID STRIP
ABRASIVE:	Ceramic Alumina	Silicon Carbide	Silicon Carbide
GRADE:	XC	XC	XC
ATTACHMENT:	TR (Type III)	TR (Type III)	TS (Type II)

SIZE (DIAMETER)	MAX. RPM	STD. PKG.	PART #	STD. PKG.	PART #	STD. PKG.	PART #
2 x 1/2	15,500	25	66623303912	10	66261013402		
3 x 1/2	12,000	25	66261096557	10	66261013403	25	66623333374
4 x 1/2 TR+	8,000	5	66623303921	5	66261016580		



FEATURED PRODUCTS

Deburring & Blending Discs



NEW

NORTON BLAZE RAPID BLEND DISCS

REVOLUTIONARY TECHNOLOGY FOR HEAVY DEBURRING AND FINISHING

FEATURES

- Norton Blaze SG ceramic alumina grain
- Special resin chemistry
- New construction: abrasive is distributed throughout the entire disc (top, bottom and side)

BENEFITS

- Quickest cut rate and up to 8X longer life than competitive aluminum oxide discs
- Resists shedding when used on sharp edges, making it ideal for deburring
- All three faces can be used – versus competitive discs’ one bottom layer of abrasive
- 3 - 8 times the life of competitive surface blending discs
- Fewer safety, ergonomic, and environmental issues due to fewer change-outs, less downtime, and less production waste/landfill scrap
- No smearing



EXPANDED OFFERING

NORTON VORTEX RAPID BLEND DISCS

REVOLUTIONARY TECHNOLOGY FOR HEAVY DEBURRING AND FINISHING

FEATURES

- Proprietary Vortex aluminum oxide aggregate grain
- Special resin chemistry
- New construction: abrasive is distributed throughout the entire disc (top, bottom and side)

BENEFITS

- Performs the medium to fine grit steps of traditional discs in an easy one-step operation
- Resists shedding when used on sharp edges, making it ideal for deburring
- All three faces can be used – versus competitive discs’ one bottom layer of abrasive
- 3 - 8 times the life of competitive surface blending discs
- Fewer safety, ergonomic, and environmental issues due to fewer change-outs, less downtime, and less production waste/landfill scrap
- No smearing



NORTON RAPID BLEND DISCS

GOOD CHOICE FOR LIGHT DEBURRING, BLENDING, AND CLEANING

FEATURES

- Open mesh construction
- New construction: abrasive is distributed throughout the entire disc (top, bottom and side)

BENEFITS

- Waterproof, washable, conformable, and non-loading
- Designed for surface generation where stock removal is not required
- All three faces can be used – versus competitive discs’ one bottom layer of abrasive
- 3 - 8 times the life of competitive surface blending discs
- Fewer safety, ergonomic, and environmental issues due to fewer change-outs, less downtime, and less production waste/landfill scrap
- No smearing

AVAILABILITY

TIER:	BEST	BETTER
BRAND::	Norton	Norton
TRADENAME:	BLAZE RAPID BLEND	VORTEX RAPID BLEND
ABRASIVE:	Ceramic Alumina	Aluminum Oxide
ATTACHMENT:	TS (Type II)	TS (Type II)



SIZE (D x T)	ABRASIVE	GRIT	DENSITY	MAX. RPM	STD. PKG.	PART #	PART #
1 x 1/4	Ceramic Alumina	XC	1	35,100	100	66623313920	
1-1/2 x 1/4	Ceramic Alumina	XC	1	35,100	80	66623313922	
2 x 1/4	Ceramic Alumina	XC	1	12,100	25	66623313925	
	Aluminum Oxide	M	1	12,100	25		66254497070
3 x 1/4	Ceramic Alumina	XC	1	12,100	25	66623313931	
	Aluminum Oxide	M	1	12,100	25		66254497069

Refer to the end of this section for a list of quick-change back-up pads.



Deburring & Blending Discs CONTINUED

AVAILABILITY

TIER:
BRAND:.
TRADENAME:
ABRASIVE:
ATTACHMENT:

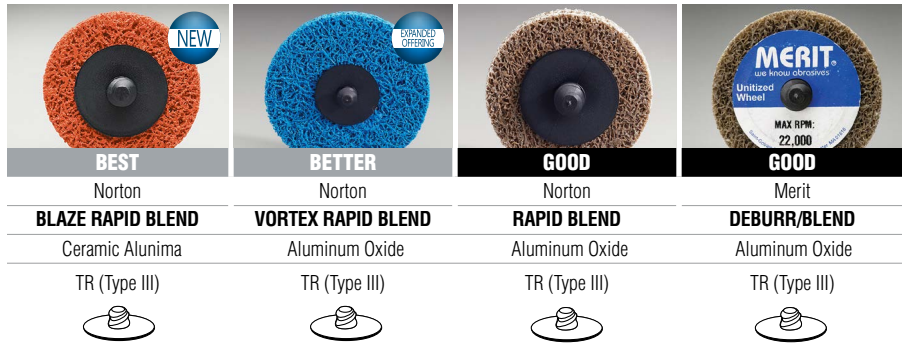

BEST	BETTER	GOOD	GOOD
Norton	Norton	Norton	Merit
BLAZE RAPID BLEND	VORTEX RAPID BLEND	RAPID BLEND	DEBURR/BLEND
Ceramic Alunima	Aluminum Oxide	Aluminum Oxide	Aluminum Oxide
TR (Type III)	TR (Type III)	TR (Type III)	TR (Type III)

SIZE (D x T)	ABR.	GRIT	DENSITY	MAX. RPM	STD. PKG.	PART #	PART #	PART #	PART #
1 x 1/4	C/A	XC	1	35,100	100	66623313919	66254497806		
	A/O	M	1	35,100	100				
1-1/2 x 1/4	C/A	XC	1	35,100	80	66623313921	66254497807		
	A/O	M	1	35,100	80				
2 x 1/8	A/O	M	4-6	22,000	60		66254425632		
	A/O	M	7-9	22,000	60				
2 x 3/16	A/O	M	2-3	22,000	60		66254433509		
2 x 1/4	C/A	XC	1	35,100	25	66623313923		66261014921	66261054187
	A/O	C	7-9	22,000	60				
	A/O	M	1	12,100	25				
	A/O	M	2-3	22,000	60				
	A/O	M	4-6	22,000	60				
	A/O	M	7-9	22,000	60				
	A/O	M	7-9	22,000	60				
	S/C	F	2	22,000	60				
	S/C	F	3	22,000	60				
	S/C	F	2-3	22,000	60				
3 x 1/8	A/O	C	7-9	15,000	40		66261093556	66261014897	66261054183
	A/O	M	2-3	15,000	40				
	A/O	M	4-6	15,000	40				
	A/O	M	7-9	15,000	40				
	A/O	F	2-3	15,000	40				
	A/O	F	4	15,000	40				
	A/O	F	6	15,000	40				
	A/O	F	2-3	15,000	40				
	A/O	F	4-6	22,000	60				
	A/O	F	4-6	22,000	60				
3 x 3/16	A/O	M	7-9	15,000	40		66254428239		
3 x 1/4	C/A	XC	1	12,100	25	66623313930		66261014922	66261054198*
	A/O	C	7-9	15,000	40				
	A/O	M	1	12,100	25				
	A/O	M	2-3	15,000	40				
	A/O	M	4-6	15,000	40				
	A/O	M	7-9	15,000	40				
	A/O	F	2-3	15,000	40				
	A/O	F	4-6	15,000	40				
	S/C	F	2	15,000	40				
	S/C	F	3	15,000	40				
S/C	F	4-6	15,000	40					
							66261014890		
							66261016005		
									66261054195*

* STD. PKG. = 20 DISCS

Refer to the end of this section for a list of quick-change back-up pads.



FEATURED PRODUCTS

Surface Preparation Discs



NORTON VORTEX RAPID PREP
BETTER CHOICE FOR FINISHING AND BLENDING APPLICATIONS

FEATURES	BENEFITS
<ul style="list-style-type: none"> Proprietary Vortex aluminum oxide abrasive grain and coating method 	<ul style="list-style-type: none"> Combines maximum cutting speed with the consistent finish of finer grits Reduce process times by 50+% by combining multiple grit sequences to 1 step More resistant to edge wear; up 4X life versus competitive products Friable grain structure keeps Ra specs throughout disc life, reducing scrap/rework
<ul style="list-style-type: none"> Clean Bond resin system, aerospace-tailored 	<ul style="list-style-type: none"> Smear-free, even on high nickel content alloys Will not load on aluminum and soft metals, as competitive products may
<ul style="list-style-type: none"> Extended form holding 	<ul style="list-style-type: none"> Lowest total cost of consumable tooling per workpiece



NORTON RAPID PREP
GOOD CHOICE FOR FINISHING AND BLENDING APPLICATIONS

FEATURES	BENEFITS
<ul style="list-style-type: none"> Clean Bond resin system, aerospace-tailored 	<ul style="list-style-type: none"> Smear-free, even on high nickel content alloys Will not load on aluminum and soft metals, as competitive products may
<ul style="list-style-type: none"> Proprietary coating method 	<ul style="list-style-type: none"> Thick layer of grain throughout the product extends life; grain does not sit on top of fibers as other competitive products may

TIER:	BETTER	GOOD	BETTER	GOOD	BETTER	GOOD
BRAND:	Norton	Norton	Norton	Norton	Norton	Norton
TRADENAME:	VORTEX RAPID PREP	RAPID PREP	VORTEX RAPID PREP	RAPID PREP	VORTEX RAPID PREP	RAPID PREP
ABRASIVE:	Aluminum Oxide	Aluminum Oxide	Aluminum Oxide	Aluminum Oxide	Aluminum Oxide	Aluminum Oxide
ATTACHMENT:	TR (Type III)	TR (Type III)	TS (Type II)	TS (Type II)	TP (Type I)	TP (Type I)



SIZE (DIAM.)	STD. PKG.	PART #	PART #	PART #	PART #	PART #	PART #
EXTRA COARSE							
3/4	50	66623325001	66623340002	66623335324	66261022401	66623325000	66623340000
1	50	66623325004	66623340007	66623325003	66623340006	66623325002	66623340004
1-1/2	50	66623325007	66623340011	66623325006	66623340010	66623325005	66623340008
2	50	66623335326	66261016373	66623335325	66261017819	66623325008	66623340012
3	25	66623335327	66261016994	66623325010	66261017818	66623325009	66623340015
4	25	66623335329	66261016374	66623335328	66623310706	66623325011	66623340018
COARSE							
3/4	50	66623325013	66623340021	66623335410	66261095015	66623325012	66623340020
1	50	66623325015	66623340023	66623335537	66261024310	66623325014	66623340022
1-1/2	50	66623335411	66261047579	66623325017	66623340026	66623325016	66623340024
2	50	66623335414	66261009191*	66623335413	66261009183	66623335412	66254498593
3	25	66623335417	66261009194	66623335416	66261009186	66623335415	66254498596
4	25	66623335419	66261008822	66623335418	66261055349	66623325018	66623340030
MEDIUM							
3/4	50	66623325020	66623340032	66623335420	66254428059	66623325019	66623340031
1	50	66623335422	66254482331	66623335421	66254482327	66623325021	66623340033
1-1/2	50	66623335424	66254482332	66623335423	66254482328	66623325022	66623340034
2	50	66623335427	66261009190*	66623335426	66261009182	66623325025	66254498520
3	25	66623335430	66261017522	66623335429	66261009185	66623335428	66254498595
4	25	66623335432	66261008821	66623335431	66261055350	66623325023	66623340039
FINE							
3/4	50	66623325026	66623340058	66623325025	66623340056	66623325024	66623340054
1	50	66623325029	66623340064	66623325028	66623340062	66623325027	66623340060
1-1/2	50	66623325032	66623340070	66623325031	66623340068	66623325030	66623340066
2	50	66623325035	66623340077	66623325034	66623340074	66623325033	66623340072
3	25	66623325038	66623340085	66623325037	66623340082	66623325036	66623340080
4	25	66623325041	66623340092	66623325040	66623340090	66623325039	66623340088
VERY FINE							
3/4	50	66623325044	66623340044	66623325043	66623340042	66623325042	66623340041
1	50	66623325047	66254482339	66623325046	66254482335	66623325045	66623340045
1-1/2	50	66623325050	66254482340	66623325049	66254482336	66623325048	66623340046
2	50	66623335433	66261009189*	66623325052	66254482337	66623325051	66254498594
3	25	66623335437	66261009192	66623335436	66261009184	66623325053	66254498597
4	25	66623325056	66623340053	66623325055	66623340052	66623325054	66623340051
SUPER FINE							
2	50		66261091459				
3	25		66261091460				

* 25 PER STANDARD PACKAGE



FEATURED PRODUCTS

Surface Preparation Stars



MERIT SURFACE PREPARATION STARS

THE PERFECT ITEM FOR ID WORK

FEATURES	BENEFITS
■ Star shape	■ Penetrates the ID and polishes or cleans the surface without disturbing any tolerances
■ 1/4-20 eyelets	■ Attach to Merit MM20-4 mandrel, Part # 08834183164 (See description at end of Overlap Slotted Disc Section.)

AVAILABILITY

TIER:	GOOD
BRAND::	Merit
TRADENAME:	SURFACE PREP
ABRASIVE:	Aluminum Oxide
ATTACHMENT:	1/4-20 Eyelet

SIZE (D x EYELET)	GRIT	STD. PKG.	PART #
1-1/2" x 1/4-20	C	100	08834185923
	M	100	08834185924
	VF	100	08834185925
2" x 1/4-20	C	100	08834185926
	M	100	08834185927
	VF	100	08834485928
3" x 1/4-20	C	100	08834185929
	M	100	08834185678
	VF	100	08834185931
4" x 1/4-20	C	100	08834185932
	M	100	08834185933
	VF	100	08834185934

SOME MERIT PART NUMBERS ARE NON-STOCK. ASK YOUR NORTON/MERIT REPRESENTATIVE FOR STOCK/MTO STATUS.

FEATURED PRODUCTS

Cross Buffs



MERIT CROSS BUFFS

EXCELLENT FOR BLENDING, POLISHING AND ID USAGE

FEATURES	BENEFITS
■ Unique design	■ Durable non-woven construction that delivers longer life and cool running
■ 8-32 eyelets	■ Attach to Merit MM32-4 mandrel. Part No. 08834183163 (See description at end of Overlap Slotted Disc Section)

AVAILABILITY

TIER:	BETTER	GOOD
BRAND::	Merit	Merit
TRADENAME:	HIGH STRENGTH	BUFFING
ABRASIVE:	Aluminum Oxide	Aluminum Oxide
ATTACHMENT:	8-32 Eyelet	8-32 Eyelet

SIZE (D x W)	GRIT	PLY	STD. PKG.	PART #	PART #
1-1/2 x 1/2	Coarse	2	100		08834188761
	Medium	2	100	08834189306	08834187312
	Very Fine	2	100	08834189307	08834188585
1-1/2 x 1/2	Coarse	3	100		66623301763
	Medium	3	100	08834189308	08834187311
	Very Fine	3	100	08834189309	08834188586

SOME MERIT PART NUMBERS ARE NON-STOCK. ASK YOUR NORTON/MERIT REPRESENTATIVE FOR STOCK/MTO STATUS.



FEATURED PRODUCTS

Buffing/Polishing Discs



BUFFING/POLISHING DISCS

DESIGNED FOR LIGHT REMOVAL OF PAINT OR RUST

FEATURES

- High-strength discs
- For light removal of paint or rust

BENEFITS

- Tough, yet conformable, and resist tearing on burrs and sharp edges
- Smear-proof
- Does not affect the base product

AVAILABILITY

TIER:	BEST
BRAND::	Norton
TRADENAME:	HIGH-STRENGTH
ABRASIVE:	Aluminum Oxide
ATTACHMENT:	TR (Type III)



BETTER	BETTER	GOOD	GOOD	GOOD
Merit	Merit	Merit	Merit	Merit
HIGH-STRENGTH	HIGH-STRENGTH	BUFFING	BUFFING	BUFFING
Aluminum Oxide	Aluminum Oxide	Aluminum Oxide	Aluminum Oxide	Aluminum Oxide
TR (Type III)	TS (Type II)	TR (Type III)	TS (Type II)	TP (Type I)



SIZE (D)	GRIT	STD. PKG.	PART #	STD. PKG.	PART #	PART #	PART #	PART #	PART #	
1-1/2	M			100				08834166368	08834166392	08834166292
	F			100				08834166369		08834166332
2	C	160	66261014792	50	08834164064	08834164244		08834161649	08834166394	08834161627
	M			50				08834166303	08834166395	08834166280
	F			50				08834166304	08834166396	08834166281
	VF			50				08834163987	08834164245	08834166305
3	C	80	66261014793	25	08834164065	08834164252		08834161651	08834166397	08834166293
	M			25				08834166308	08834166398	08834166284
	F			25				08834166309	08834166399	08834166285
	VF			25				08834163559	08834164255	08834166310
4	M			25				08834166401		

SOME MERIT PART NUMBERS ARE NON-STOCK. ASK YOUR NORTON/MERIT REPRESENTATIVE FOR STOCK/MTO STATUS.

Quick-Change Back-up Pads

- Hard density pads are for aggressive cutting action
- Medium density pads are for all-purpose applications
- Soft density pads are used for contours and fine finishing work

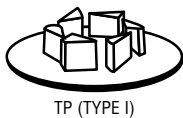
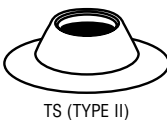
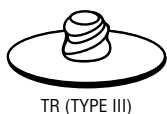

AVAILABILITY

TIER:	GOOD	GOOD	GOOD	GOOD	GOOD
BRAND::	Norton	Merit	Norton	Merit	Merit
ATTACHMENT:	TR (Type III)	TR (Type III)	TS (Type II)	TS (Type II)	TP (Type I)

SIZE (DIAMETER)	MAX. RPM	DENSITY	PART #	PART #	PART #	PART #	PART #
Quick-Change Back-up Pads							
3/4"	40,000	Medium		08834164038		08834164206	08834164001
1"	40,000	Medium		08834164037		08834164651	08834164002
1-1/2"	30,000	Hard		08834164640		08834164622	08834163996
	30,000	Medium	66261047580	08834161174		08834164146	08834164003
2"	30,000	Hard		08834164643	63642543205	08834164624	08834163997
	30,000	Medium	66261055103	08834164922	63642543210	08834164198	08834164004
	30,000	Soft		08834164641		08834161625	08834163949
3"	20,000	Hard	63642504900	08834164036	63642543220	08834161626	08834163998
	20,000	Medium	66261055105	08834164949	63642543225	08834164113	08834164005
	20,000	Soft		08834164644		08834164626	08834163948
4"	15,000	Medium	66261047581	08834164655	63642543232	08834164135	08834164006
4" TR+	8,000	Medium	66261016581	63642555106			

ALL QUICK-CHANGE BACK-UP PADS HAVE A 1/4" DIAMETER SHANK. STD. PKG. = 1

Refer to the end of the Coated Abrasive Quick-Change Discs section for a complete list of back-up pads and mandrels.



FEATURED PRODUCTS

Non-Woven Hook and Loop Discs



NORTON VORTEX RAPID PREP

BETTER CHOICE FOR FINISHING AND BLENDING APPLICATIONS

FEATURES

BENEFITS

- | | |
|--|--|
| <ul style="list-style-type: none"> ■ Proprietary Vortex aluminum oxide abrasive grain and coating method ■ Clean Bond resin system, aerospace-tailored ■ Improved hook and loop backing | <ul style="list-style-type: none"> ■ Most consistent cutting and finishing of surface conditioning products on the market ■ Combines maximum cutting speed with the finish of finer grits ■ Reduce process times by 50+% by combining multiple grit sequences to 1 step in a blending operation ■ More resistant to edge wear; up 4X life vs. competitive products ■ Friable grain structure keeps Ra specs throughout disc life and reduces scrap and rework ■ Smear-free, even on high nickel content alloys ■ Will not load on aluminum and soft metals, as competitive products may ■ Will not fly off rotary sanders ■ Discs sit flatter on back-up pads, resulting in a more consistent finish on DA applications |
|--|--|

AVAILABILITY

TIER:
BRAND:
TRADENAME:
ABRASIVE:

		BETTER	GOOD
		Norton	Norton
		VORTEX RAPID PREP	RAPID PREP
		Aluminum Oxide	Aluminum Oxide
SIZE (DIAMETER)	STD. PKG.	PART #	PART #
EXTRA COARSE			
1-1/2	50	66623325061	66623340098
2	50	66623334970	66261017900
3	25	66623333620	66623326059
4	25	66623334971	66261017382
4-1/2	25	66623334972	66261017906
5	25	66623334974	66261017215
6	25	66623333621	66623326077
7	25	66623334976	66261192846
8	25	66623334977	66261017531
COARSE			
1-1/2	50	66623325057	66623340099
2	50	66623334882	66261004431*
3	25	66623334883	66261055015
4	25	66623334884	66261055018
4-1/2	25	66623334943	66261017806
5	25	66623334945	66261004435
6	25	66623334949	66261006910
7	25	66623334951	66261055027
8	25	66623334953	66261006913
MEDIUM			
1-1/2	50	66623325059	66623338571
2	50	66623334958	66261004441
3	25	66623334956	66261004442
4	25	66623334959	66261055019
4-1/2	25	66623334961	66261004444
5	25	66623334962	66261055022
6	25	66623334964	66261006911
7	25	66623334965	66261017813
8	25	66623334966	66261017815
FINE			
1-1/2	50	66623325058	66623340101
2	50	66623333604	66623325141
3	25	66623333605	66623325143
4	25	66623333606	66623325145
4-1/2	25	66623333607	66623325147
5	25	66623333609	66623325154
6	25	66623333610	66623325160
7	25	66623334955	66261199465
8	25	66623333611	66623325907

* STANDARD PACKAGE = 80

CONTINUED



Non-Woven Hook and Loop Discs CONTINUED

AVAILABILITY

		TIER: BETTER	GOOD
		BRAND: Norton	Norton
		TRADENAME: VORTEX RAPID PREP	RAPID PREP
		ABRASIVE: Aluminum Oxide	Aluminum Oxide
SIZE (DIAMETER)	STD. PKG.	PART #	PART #
VERY FINE			
1-1/2	50	66623325060	66623340100
2	50	66623333613	66623325926
3	25	66623333614	66623325934
4	25	66623334967	66261055020
4-1/2	25	66623333615	66623325936
5	25	66623333617	66623325941
6	25	66623334968	66261055026
7	25	66623334969	66261019990
8	25	66623333619	66623325972
SUPER FINE			
4-1/2	25		66261094948
5	25		66261019962
7	25		66261094949



Back-Up Pads for Hook And Loop Discs

AVAILABILITY

					TIER: GOOD	GOOD
					BRAND: Norton	Merit
PAD DIAMETER	SPINDLE OR HOLE SIZE	MAX. RPM	3M EQUIVALENT	STD. PKG.	PART #	PART #
Back-Up Pads for Hook And Loop Discs						
2	1/4 Steel Shank	23,000	922	5	66261059352	08834168025*
3	1/4 Steel Shank	20,000	923	5	66261059354	08834168026*
4	1/4 Steel Shank	18,000	924	5	66261059356	08834168027*
	1/2-13	13,000	914	5	66261059303	05539562714
	5/8-11	13,000	914	5	66261059304	08834168984*
	M10 x 1.250	13,000		5	66261059305	
4-1/2	5/8-11	10,000	9145	5	66261006948	05539562718
5	5/16-24 Male	10,000	905	5	66261059360	08834168993**
	3/8-24 Male	10,000	905	5	66261059308	08834168028*
	5/8-11	10,000	915	5	66261059310	08834168967*
6	5/8-11	8,000	916	5	66261059312	05539562723
7	5/8-11	6,000	917	5	66261059368	08834168032*
8	5/8-11	4,500	918	5	66261059372	

* = 1 PER PKG, ** = 2 PER STD PKG.



FEATURED PRODUCTS

Non-Woven High Strength Discs



HIGH STRENGTH AND FASTCUT DISCS

BETTER CHOICE FOR LIGHT DEBURRING AND FINISHING

FEATURES

- Firm, durable web
- Tough, yet conformable
- Strong, smear-proof resin binders

BENEFITS

- High resistance to tearing on burrs and sharp edges
- Can be "ganged" together and used as a wheel
- Produce light satin finishes

Applications include rust/oxide or coating removal, pipe ID and OD polishing, casting cleaning, highlighting (antiquing), contaminant removal, removal of handling marks, gasket removal, cleaning and blending of surface imperfections, prepping prior to soldering, removal of filling materials, cleaning angles and odd shapes. Will not stretch or shed. Ganging increases versatility.

AVAILABILITY

TIER:	BEST	BETTER	GOOD
BRAND:	Norton	Norton	Merit
TRADENAME:	FAST CUT	HIGH STRENGTH	HIGH STRENGTH
ABRASIVE:	Aluminum Oxide	Aluminum Oxide	Aluminum Oxide

SIZE (D x H)	GRIT	MAX. RPM	STD. PKG.	PART #	PART #	STD. PKG.	PART #
6 x 1/4	VF	4,000	70		66261007628		
6 x 1/2	M	4,000	70		66261005073	25	08834162410
	F	4,000	70			25	08834167735
	VF	4,000	70	66261000601	66261004980	25	08834162411
8 x 1/2	M	3,000	50		66261005491	25	08834162412
	VF	3,000	50		66261004506	25	08834162413
12 x 1-1/4	VF	1,900	25		66261008723		



FITS HOLE	FOR DISC WIDTH	FOR DISC DIAMETER	SHANK DIAMETER	OVERALL LENGTH	WASHER DIAMETER	STD. PKG.	PART #
Mandrel Assemblies for using Discs on Edge							
1/4"	1/2" (Standard)	up to 6"	1/4"	2-1/2"	1-1/2"	1	66261009502
1/2"	1/2" (Standard)	Up to 8"	1/4"	3-1/8"	2-1/4"	1	66261059420

FEATURED PRODUCTS

Non-Woven Disc Wheels



MERIT DISC WHEELS

GOOD CHOICE FOR LIGHT DEBURRING AND FINISHING

FEATURES

- Discs are "ganged" together to form a wheel

BENEFITS

- Mounted on a 1/4" steel mandrel embedded in an epoxy core
- Strong and durable

MACHINES USED



AVAILABILITY

TIER:	GOOD
BRAND:	Merit
ABRASIVE:	Aluminum Oxide

SIZE (D x W x 1/4 SHANK)	GRIT	PLY	MAX. RPM	STD. PKG.	PART #
2 x 1/2	Medium	2 Ply	12,000	10	08834131551
2 x 1	Medium	4 Ply	12,000	10	08834131554
3 x 1/2	Medium	2 Ply	8,000	10	08834131558
	Very Fine	3 Ply	8,000	10	08834131560
3 x 1	Medium	4 Ply	8,000	10	08834131496
	Fine	5 Ply	8,000	10	08834131557
	Very Fine	5 Ply	8,000	10	08834131497
4 x 1/2	Fine	3 Ply	6,000	10	08834131562
4 x 1	Medium	4 Ply	6,000	10	08834131564
5 x 1/2	Medium	2 Ply	4,000	10	08834131567
5 x 1	Medium	4 Ply	4,000	10	08834131570
	Fine	5 Ply	4,000	10	08834131571

DISC WHEELS ARE CONSTRUCTED BY NUMBER OF PLYS. THE ACTUAL FACE WIDTH WILL VARY AND WILL NOT MATCH THE LISTED WIDTH EXACTLY. FACE WIDTH IS GIVEN FOR REFERENCE ONLY.

SOME MERIT PART NUMBERS ARE NON-STOCK. ASK YOUR NORTON/MERIT REPRESENTATIVE FOR STOCK/MTO STATUS.



FEATURED PRODUCTS

Non-Woven Abrasive Brushes



NON-WOVEN ABRASIVE BRUSHES



BACK-UP PAD

NON-WOVEN ABRASIVE BRUSHES – TYPE 27

USE WHERE MAXIMUM CONFORMABILITY IS NEEDED

FEATURES

- Feature tough, flexible nylon filaments embedded with abrasive grain

BENEFITS

- Provide finishing and polishing where maximum conformability is needed

AVAILABILITY

TIER:	GOOD	GOOD
BRAND:	Norton	Norton
ABRASIVE:	Silicon Carbide	Silicon Carbide
GRIT SIZE:	80	120

SIZE (D x T x H)	MAX. RPM	STD. PKG.	PART #	PART #
Abrasive Brush				
7 x 1 x 7/8	6,000	5	66261058830	66261058834
USE WITH AIR-COOLED RUBBER BACK-UP PAD AND RETAINER NUT				
Abrasive Brush Back-up Pads				
7" Medium	8,600	5	63642543422	



NEW

THIN and FLEXIBLE: Perfect for Tight Spots

Norton Bear-Tex Thin-Flex High-Performance Hand Pads

- Achieve performance benefits of a Coarse and Fine grain product in one hand pad: fast cut and definitively better finish than competing pads.
- Extremely thin and conformable; ideal for cleaning, blending, finishing and deburring contoured surfaces and tight spaces
- Special coated web design for superior and constant cutting action without added effort from user
- Versatile; ideal for woodworking, metalworking, maintenance operations, and synthetics fabrication



CATEGORY DEFINITION

Surface finishing hand pads and rolls are made of a non-woven nylon web impregnated with abrasive grain and resin bond.

APPLICATIONS: Light- to heavy-duty cleaning, deburring, blending, polishing, and finishing of metal, wood, composite, plastics, stone, solid surface and painted surfaces.

ABRASIVE GRAIN: Aluminum Oxide, Silicon Carbide

GRIT RANGE: Medium (M), Fine (F), Very Fine (VF), Ultra Fine (UF), Micro Fine (MF), Non-Abrasive (-)

HAND PAD FEATURES:

- Flexible; conform to work surface
- Gentle action easily removes flashing or burrs without affecting dimension of workpiece
- Non-loading; constant supply of new cutting edges
- Non-rusting; no workpiece contamination
- Resilient construction; long life, increased productivity; solvent resistant; waterproof

SPONGE PAD FEATURES:

- Non-woven material is laminated to a long-lasting sponge for the convenience of 2 pads in one
- Superior replacement for steel wool

ROLL FEATURES:

- Economical alternative to cut pads
- Can be cut to specific sizes

APPLICATION/GRIT RECOMMENDATION GUIDE

← MORE AGGRESSIVE, ROUGHER FINISH

LESS AGGRESSIVE, FINER FINISH →

PRODUCT #:
COLOR:
DESCRIPTION:

ABRASIVE:

GRIT SIZE:

STEEL WOOL
EQUIVALENT:

APPLICATIONS:

	#740 DARK TAN HEAVY DUTY	#746 GRAY BLENDING	#644 MAROON GP - FINE	#747 MAROON GP PLUS - VERY FINE	#796 GREEN SCOURING	#635 GRAY CLEAN & FINISH	#748 GRAY FINAL SHINE	THIN-FLEX VF MAROON CLEANING	THIN-FLEX UF GRAY CLEANING	#456 WHITE CLEANING
	AO	SC	AO	AO	AO	SC	SC	AO	SC	Non-Abrasive
	Medium 100 - 150	Medium 100 - 150	Fine 180 - 220	Very Fine 240 - 360	Very Fine 240 - 360	Ultra Fine 400 - 600	Micro Fine 800 - 1200	Very Fine 240 - 360	Ultra Fine 400 - 600	Non-Abrasive ----
	4 Extra Coarse	3 Coarse	2 Medium Coarse	1 Medium	0 Fine	00 Very Fine	00 Very Fine	00 Very Fine	000 Extra Fine	0000 SuperFine
	<ul style="list-style-type: none"> • Smear-free Clean Bond technology • 2X life • Most durable and aggressive cutting pad • Heavy-duty removal - rust - oxidation • Deburring 	<ul style="list-style-type: none"> • Blending and deburring - welds - aluminum - stainless 	<ul style="list-style-type: none"> • Cleaning and deburring - machinery - metal parts - plastic - solid surface - stone 	<ul style="list-style-type: none"> • Light cleaning, deburring and finishing - machinery - metal parts - solid surface - stone 	<ul style="list-style-type: none"> • Removing stains, marks, rust, corrosion or oxidation from stainless equipment • Light cleaning of metal surfaces 	<ul style="list-style-type: none"> • Light cleaning and finishing of most surfaces - steel, aluminum - denibbing plastic - scuffing acrylics 	<ul style="list-style-type: none"> • Final finishing - final rub on wood - final blend on metal - final finish on plastics and acrylics 	<ul style="list-style-type: none"> • Maximum flexibility for consistent finishes • Cleaning blending, finishing, and deburring in woodwork, metalwork, MRO, and synthetic applications 	<ul style="list-style-type: none"> • Maximum flexibility for consistent finishes • Cleaning blending, finishing, and deburring in woodwork, metalwork, MRO, and synthetic applications 	<ul style="list-style-type: none"> • Scratch-free cleaning - metal - fiberglass - stone - solid surface - ceramic • Wood - highlighting - rubbing

CROSS REFERENCE GUIDE

← COARSER

FINER →

	#740	#746	#644	#747	#796	#635	#748	Thin-Flex VF	Thin Flex UF	#456
NORTON	#740	#746	#644	#747	#796	#635	#748	Thin-Flex VF	Thin Flex UF	#456
3M	7440	7446	64659	7447/8447 Production Hand Pad	96	64660	7448	Multi-Flex Maroon	Multi-Flex Gray	7445
Camel	Tan	-	-	Maroon	Green	-	Grey	-	-	White
Mirka	-	-	-	Maroon/Red VF	-	-	-	Mirlon Total Maroon	Mirlon Total Gray	-
Sait	Brown	-	-	Maroon	Green	-	Gray	-	-	-
SIA	6912 Brown	6712 Grey	-	6912 Maroon	6312 Green	-	-	-	-	-
Standard	HD-Tan AO	-	-	GP-Maroon VF	Green-AO	HP-VF	UF Gray	-	-	Cleaning White



AVAILABILITY

SIZE (W x L)	COLOR	DESCRIPTION	ABRASIVE	GRIT SIZE	STD. PKG.	TIER:		
						BEST	BETTER	GOOD
BRAND::					Norton			
					PART #	PART #	PART #	
Hand Pads								
4-1/2 x 9	Maroon	Thin Flex Cleaning Pad	A/O	VF	25	66623398062		
	Grey	Thin Flex Cleaning Pad	S/C	UF	25	66623398063		
6 x 9	Dark Tan	740 Heavy-Duty Pad IMPROVED!	A/O	Med	40			66261074000
	Gray	746 Blending Pad	S/C	Med	40			66261074600
	Maroon	777 General Purpose Very Fine Pad	A/O	VF	60			66261077700
	Maroon	747 General Purpose Plus Pad	A/O	VF	60		66261074700	
	Maroon	847 General Purpose Plus Perforated Pad	A/O	VF	60		66261084700	
	Green	796 Scouring Pad	A/O	VF	60			66261079600
	Lt. Green	696 Food Pro Pad	A/O	VF	60			66261069600
	Gray	851 General Cleaning Pad	S/C	VF	40			66261085100
	Gray	635 Clean & Finish Pad	S/C	UF	60			66261063500
	Gray	748 Final Shine Pad	S/C	MF	60			66261074800
White	456 Cleaning Pad	None	-	60			66261045600	
Hand Pad Holder								
3-1/4 x 5-1/2	N/A	Hand Pad Holder			10			66261047583
Rolls								
4" x 30 Ft.	Maroon	High Strength Roll	A/O	M	3		66261006358	
	Dark Tan	740 Heavy-Duty Roll IMPROVED!	A/O	M	3			66261010081
	Maroon	644 General Purpose Fine Roll	A/O	F	4			66261058364
	Maroon	777 General Purpose Very Fine Roll	A/O	VF	4		66261006373	66261058361
	Maroon	747 General Purpose Plus Roll	A/O	VF	4		66261051701	
	Gray	851 General Cleaning Roll	S/C	VF	4			66261058360
	Gray	635 Clean & Finish Roll	S/C	UF	5			66261058357
6" x 30 Ft.	Maroon	High Strength Roll	A/O	M	2		66261005182	
	Maroon	747 General Purpose Plus Roll	A/O	VF	3		66261016430	
	Maroon	777 General Purpose Very Fine Roll	A/O	VF	3		66261004281	66261058376
	Gray	851 General Cleaning Roll	S/C	VF	3			66261058377
2" x 15 Ft. Handy Roll Pack	Assorted	1 each A/O Fine, A/O VF, SC MF	-	-	1			66261008108
Scouring Pads/Sponges								
3-1/4 x 6-1/4 x 3/4	Green/Yellow	893 Scour-N-Sponge Pad	A/O	VF	40			66261059403
3-1/4 x 6-1/4 x 3/4	White/Yellow	875 Clean-N-Sponge Pad	None	-	40			66261059402



Put Our Technology To Work!

UPGRADED PERFORMANCE Norton Bear-Tex 740 Hand Pad

Revolutionize your operation with our technological breakthrough for aggressive and rough metalworking applications. Our Clean Bond resin technology makes 740 heavy-duty hand pads more aggressive and durable than ever before.

FEATURES & BENEFITS

- Up to two times more life vs. competitive and former Norton products
- Increased grain retention for increased cutting capabilities
- Ultra flexible resin for added user comfort
- Ultra conformable for superior surface finish consistency

Our 740 series of products are available in non-stock sizes and shapes. Contact your Norton sales representative for samples.



CATEGORY DEFINITION

Made from non-woven synthetic fiber mesh, which is impregnated with abrasives and bound with resins, non-woven wheels are designed to create desired surface finish where little or no stock removal is required. The industry's broadest offering is available for light stock removal, deburring, blending, finishing and polishing. Non-woven wheels have an open mesh construction that is waterproof, washable, conformable and non-loading.

APPLICATIONS: Cleaning and removing imperfections on metal surfaces, cleaning built-up residue, deburring or finishing a variety of surfaces, blending weld seams or creating decorative finishes. Non-woven surface finishing products have excellent versatility.

ABRASIVE GRAIN: Aluminum Oxide, Silicon Carbide

GRIT RANGE: Extra Coarse (XC), Coarse (C), Medium (M), Fine (F),

APPLICATION/GRIT RECOMMENDATION GUIDE

NORTON	MOST AGGRESSIVE ← → LEAST AGGRESSIVE						
	RAPID STRIP WHEELS	RAPID BLEND UNIFIED WHEELS	SERIES 4000 & 1000 CONVOLUTE WHEELS	METAL FINISHING CONVOLUTE WHEELS	CLEAN & FINISH CONVOLUTE WHEELS	LIGHT FINISHING CONVOLUTE WHEELS	NON-WOVEN / INTERLEAF FLAP WHEELS
SCALE REMOVAL	BEST CHOICE						
STOCK REMOVAL		BEST CHOICE	2ND CHOICE				
HEAVY DEBURRING		BEST CHOICE	2ND CHOICE				
DECORATIVE FINISHING				BEST CHOICE	2ND CHOICE		
BLENDING			BEST CHOICE	2ND CHOICE			
CLEANING				2ND CHOICE	BEST CHOICE		
LIGHT DEBURRING			2ND CHOICE			BEST CHOICE	
LIGHT FINISHING			2ND CHOICE			BEST CHOICE	
POLISHING						BEST CHOICE	2ND CHOICE
BUFFING							BEST CHOICE

SURFACE FINISH VARIABLES

Changes in any one of many factors can affect the surface finish on the workpiece. This chart shows the effect on surface finish by changes in single factors of product specifications. Arrows have been used to signify the trend direction. The arrow length does not signify that the effect of each factor is equal.

Variable Factor	Rough Finish High Rms Reading	Smooth Surface Lower Rms Reading
1. Wheel Speed	Slow ←	Fast →
2. Feed Speed	Faster (Long Scratch) ←	Slower (Short Scratch) →
3. Oscillation	No Oscillation ←	Oscillation →
4. Lubricants	Dry ←	Water ← Soluble Oil ← Straight Oil →
		← Compounds →

NON-WOVEN MARKING SYSTEM

ABRASIVE	S/C ←	→ A/O		
	SHARPER, FINER/BRIGHTER SCRATCH PATTERN	MORE DURABLE, LONGER LASTING, POLISHED FINISH		
GRIT SIZE	XC (24-36) ←	C (50-80)	M (100-150)	F (180-220) →
	FASTER, AGGRESSIVE CUT, ROUGHER FINISH			REDUCED CUT RATE, FINER FINISH
DENSITY	2 ←	→ 9		
	SOFT, OPEN, CONFORMABLE, LESS BURNING/LOADING	HARDER, MORE DURABLE, FASTER CUTTING, BETTER FINISH		



CROSS REFERENCE GUIDE

	STRIPPING	HEAVY/LIGHT DEBURRING	LIGHT DEBURRING/BLENDING/POLISHING				CLEANING/FINISHING		
NORTON	GOOD Rapid Strip	BEST Vortex Rapid Blend	GOOD NEX Rapid Blend	BEST Series 4000	BETTER Series 1000	BEST Light Finishing	BEST Metal Finishing	BEST Clean & Finish	GOOD Non-Woven / Interleaf Flap Wheels
3M	Clean Strip	Cut & Polish Unitized	EXL Unitized	EX2 & EX3	EXL Deburring	Light Deburring	Metal Finishing	Multi Finishing	Finishing Flap Brush
Standard	Britestrip	800 & 900 Series	500 - 700 Series	GP Plus	Deburring Convolute	LDW	Metal Finishing	Multi Finishing	Buff & Blend Flap Brush

Rapid Strip Wheels



NORTON RAPID STRIP WHEELS

IDEAL FOR REMOVING COATINGS ON A VARIETY OF SUBSTRATES, SUCH AS WOOD, METAL AND PLASTICS

FEATURES

- Extruded nylon fibers, flexible resin technology, and extra-coarse silicon carbide mineral

BENEFITS

- Provide a unique combination of aggressive performance, long life, and improved finish while outperforming traditional coated abrasives
- Leave a thoroughly cleaned surface that ensures excellent adhesion for subsequent processes such as coating, painting and soldering.

AVAILABILITY

TIER:	GOOD
BRAND:	Norton
TRADENAME:	RAPID STRIP WHEELS
GRIT:	Extra Coarse

SIZE	MAX. RPM	STD. PKG.	PART #
Arbor Hole			
4 x 1/4	8,000	25	66261008008
4 x 1/2	8,000	25	66261007916
6 x 1/2	5,500	15	66261008051

Rapid Blend Unified Wheels

Designed for maintenance operations needing an efficient and cost-effective method of deburring, polishing, cleaning or finishing metals and composites. Easily preformed for use on a wide variety of shapes/contours. Hold shape well; less wheel dressing. Non-metallic so no contamination of workpiece. Uniform construction maintains part tolerance; prevents cutting or gouging.



NORTON VORTEX RAPID BLEND UNIFIED WHEELS

BETTER CHOICE FOR LIGHT WELD BEAD AND WELD SPLATTER REMOVAL, HEAVY DEBURRING AND FINISHING APPLICATIONS

FEATURES

- High-performance engineered grain and improved resin bond system
- Thick nylon web
- Controlled porosity

BENEFITS

- Aggressive, fast, stock removal, reduced cycle times, and increased part quality
- 2X longer life and faster finishing – with minimal shedding
- Cool cutting and improved cut rate

AVAILABILITY

TIER:	BETTER
BRAND:	Norton
TRADENAME:	VORTEX RAPID BLEND UNIFIED WHEELS

SIZE (D x T x H)	ABRASIVE	GRIT SIZE	STD. PKG.	MAX. RPM	3 DENSITY PART #	MAX. RPM	5 DENSITY PART #	MAX. RPM	7 DENSITY PART #	MAX. RPM	9 DENSITY PART #
2 x 1/8 x 1/8	A/O	M	60			22,000	66254425657	20,000	66254410849		
2 x 1/8 x 1/4	A/O	M	60			22,000	66254406346	22,000	66261191446		
2 x 1/4 x 1/4	A/O	M	60	18,000	66254428456	22,000	66254433504	22,000	66261080270		
2 x 1 x 1/4	A/O	M	15					22,000	66261080269		
3 x 1/8 x 1/4	A/O	M	40			18,000	66261093448	18,000	66261191445		
3 x 1/8 x 3/8	A/O	M	40			18,000	66254433503	18,000	66254401131		
3 x 1/4 x 1/4	A/O	M	40	12,000	66254428454	18,000	66254414832	18,000	66261199696		
3 x 1/4 x 3/8	A/O	M	40	12,000	66254433505	12,000	66254433506	18,000	66261199697		
3 x 1/2 x 1/4	A/O	M	20			18,000	66254432925	18,000	66261080267	18,000	66254433507
3 x 1/2 x 3/8	A/O	M	20			18,000	66254433508	18,000	66261080266	18,000	66254420696



Rapid Blend Unified Wheels CONTINUED



NORTON NEX RAPID BLEND WHEELS
GOOD CHOICE FOR LIGHT DEBURRING AND BLENDING

FEATURES

- Uniform construction
- Smear-resistant formula

BENEFITS

- Extra long life
- Excellent, consistent, smear-free finishes

AVAILABILITY

TIER:

GOOD

BRAND:

Norton

TRADENAME:

NEX RAPID BLEND UNIFIED WHEELS

SIZE (D x T x H)	ABRASIVE	GRIT	MAX. RPM	STD. PKG.	2 DENSITY PART #	3 DENSITY PART #	4 DENSITY PART #	6 DENSITY PART #	7 DENSITY PART #	8 DENSITY PART #
1 x 1 x 3/16	A/O	C	30,000	50						66261014915
	A/O	M	18,000	50	66261014891					
	A/O	M	30,000	50				66261014908		66261014924
	A/O	F	30,000	50				66261014900		
	S/C	F	18,000	50	66261014883					
2 x 1/8 x 1/4	A/O	M	22,000	60						66261014923
	S/C	F	30,000	50				66261014904		66261014927
2 x 1/4 x 1/4	A/O	C	22,000	60						66261014916
	A/O	M	18,000	60	66261014892					
	A/O	M	22,000	60						66261014926
	A/O	F	22,000	60				66261014901		
	S/C	M	22,000	60						66261014964
3 x 1/4 x 1/4	S/C	F	18,000	60	66261014884					
	A/O	M	22,000	30						66261014925
3 x 1/8 x 1/4	A/O	M	18,000	40						66261014934
3 x 1/4 x 1/4	A/O	C	18,000	40						66261014919
	A/O	M	12,000	40	66261014894					
	A/O	M	18,000	40				66261014909		66261014930
	A/O	F	18,000	40			66261015565	66261014902		
	S/C	M	18,000	40						66261014937
3 x 1/4 x 3/8	S/C	F	12,000	40	66261014886	66261016392				
	A/O	C	18,000	40						66261014920
	A/O	M	12,000	40	66261014895					
	A/O	M	18,000	40				66261014910		66261014933
	A/O	F	12,000	40			66261014899			
3 x 1/2 x 1/4	S/C	M	18,000	40						66261014965
	S/C	F	12,000	40	66261014887	66261016006				
	S/C	F	18,000	40				66261014905		
3 x 1/2 x 3/8	A/O	C	18,000	20						66261014917
	A/O	M	12,000	20	66261014893					
	A/O	M	18,000	20				66261014928		
	S/C	F	12,000	20	66261014885					
3 x 1 x 3/8	A/O	C	18,000	20						66261014918
	A/O	M	18,000	20						66261014929
6 x 1/2 x 1	S/C	XC	14,000	10					66261014914	
	A/O	M	7,500	4						66261014931
6 x 1 x 1	A/O	M	5,000	2	66261014896					
	S/C	F	5,000	2	66261014888					



Rapid Blend Unified Wheels CONTINUED



AVAILABILITY

NORTON RAPID BLEND DEBURRING UNIFIED WHEELS
GOOD STARTING SPECIFICATION FOR HIGH-SPEED DEBURRING APPLICATIONS

FEATURES

■ Controlled density range

BENEFITS

■ More durable than General Duty Wheels

TIER: **GOOD**

BRAND: Norton

TRADENAME: **RAPID BLEND DEBURRING UNIFIED WHEELS**

SIZE (D x T x H)	ABRASIVE	GRIT	MAX. RPM	STD. PKG.	PART #
2 x 1/4 x 1/4	A/O	220	20,000	60	66261052200
2 x 1/2 x 1/4	A/O	120	20,000	40	66261058876
	S/C	220	20,000	40	66261058782
3 x 1/4 x 1/4	A/O	220	18,000	40	66261058877
	S/C	220	18,000	40	66261058854
3 x 1/2 x 1/4	S/C	220	18,000	20	66261058859
3 x 3/4 x 1/4	A/O	220	18,000	20	66261058881



AVAILABILITY

NORTON RAPID BLEND GENERAL DUTY DEBURRING UNIFIED WHEELS
GOOD CHOICE FOR GENERAL PURPOSE LIGHT DEBURRING APPLICATIONS

FEATURES

■ Outstanding resistance to snagging

BENEFITS

■ For general purpose light deburring applications

TIER: **GOOD**

BRAND: Norton

TRADENAME: **RAPID BLEND GENERAL DUTY UNIFIED WHEELS**

SIZE (D x T x H)	ABRASIVE	GRIT	DENSITY	MAX. RPM	STD. PKG.	PART #
1 x 1 x 3/16	A/O	C	8	15,000	50	66261000938
2 x 1/4 x 1/4	A/O	C	8	11,000	60	66261052275
2 x 1/2 x 1/4	A/O	F	4	11,000	40	66261058764
3 x 1/4 x 1/4	A/O	C	8	8,000	40	66261052276
	A/O	F	4	8,000	40	66261058816
	S/C	F	4	8,000	40	66261000745
3 x 1/2 x 1/4	A/O	F	4	8,000	20	66261054046
	S/C	F	4	8,000	20	66261054048
3 x 3/4 x 1/4	A/O	F	4	8,000	20	66261058769
	S/C	M	4	8,000	20	66261058773
	S/C	F	4	8,000	20	66261058771
6 x 1/2 x 1/2	S/C	M	4	4,800	8	66261058779
6 x 1 x 1/2	S/C	M	4	4,800	4	66261058792
	S/C	F	4	4,800	4	66261058790
6 x 1 x 1	S/C	F	4	4,800	4	66261058797



Mandrels for Unified Wheels

FITS WHEEL CENTER HOLE	FOR WHEEL WIDTH	FOR WHEEL DIAMETER	SHANK DIAMETER	OVERALL LENGTH	WASHER DIAMETER	3M EQUIVALENT	STD. PKG.	PART #
Mandrel Assemblies for Unified Wheels and Discs on Edge								
1/8 – 3/16	Up to 1/2	Up to 2	1/8	1-3/4	7/16	931	1	66261009849
3/16	1/8 – 1/2	1 – 2	1/4	2	7/16	994	1	66261009852
1/4 – 5/16	Up to 1/2	Up to 2	1/4	2	5/8	932	1	66261015146
1/4 – 5/16	Up to 1	Up to 2	1/4	2-1/2	5/8	932	1	66261059422
	Up to 1	2 – 3	1/4	2-1/2	1	933	1	66261059421
3/8	Up to 1/2	2 – 4	1/4	2-1/2	1	990	1	66261009851
1/2	Up to 1	3 – 6	1/4	3-1/8	1-5/8	934	1	66261009850

FOR CENTER HOLE	USE WITH UNIFIED WHEEL	SHANK DIAMETER	SHANK LENGTH	3M EQUIVALENT	STD. PKG.	PART #
Threaded Mandrel for Unified Wheels						
3/16	1 x 1 x 3/16	1/4"	1-3/4"	948	5	66261047584



MANDREL ASSEMBLY 66261059421



MANDREL ASSEMBLY 66261059422



THREADED MANDREL 66261047584





Convolute Wheels

Formed by wrapping and bonding web material impregnated with abrasive grain and resin around a center core. Convolute wheels offer a wide range of uses:

- Burr and flashing removal
- Surface roughness reduction
- Blending weld areas on stainless steel
- Blending scratch patterns
- Weld polishing
- Removing rust and oxides
- Applying decorative finishes including antique patterns

TECHtip

- Convolute wheels must always run in the direction indicated by the arrow printed on the side of each wheel.
- Light to medium pressure is recommended. Excessive pressure may result in part damage.
- Lubricants such as water-soluble oil and straight oil will decrease the heat and improve the surface finish and lustre.

 It is the user's responsibility to refer to and comply with all safety regulations.

FEATURED PRODUCTS



SERIES 4000 RAPID FINISH CONVOLUTE WHEELS BEST CHOICE FOR HEAVY DEBURRING APPLICATIONS

FEATURES

- Advanced resin bond system
- High quality synthetic web

BENEFITS

- Free cutting
- Use both wet and dry
- Long life for heavy deburring, edge breaking and removing parting lines on exotic metals

AVAILABILITY

TIER: **BEST**
 BRAND: Norton
 TRADENAME: **SERIES 4000 RAPID FINISH CONVOLUTE WHEELS**

SIZE (D x T x H)	ABRASIVE	GRIT	MAX. RPM	STD. PKG.	8 DENSITY PART #	9 DENSITY PART #
Series 4000 Rapid Finish Convolute Wheels						
6 x 1/2 x 1	S/C	F	6,000	4		66261004021
6 x 1 x 1	A/O	M	6,000	3	66261004208	
	S/C	F	6,000	3	66261004142	66261004141
8 x 1 x 3	A/O	M	4,500	3	66261004165	
	S/C	F	4,500	3	66261004123	66261004135
12 x 1 x 5	S/C	F	3,000	2	66261004284	66261004148
12 x 2 x 5	S/C	F	3,000	1		66261004011



BEAR-TEX[®]

Convolute Wheels CONTINUED



SERIES 1000 LONG LIFE RAPID FINISH CONVOLUTE WHEELS
 BETTER CHOICE FOR GENERAL DEBURRING, BLENDING, AND FINAL FINISHING

FEATURES	BENEFITS
■ Smear and heat-resistant formula	■ Consistent, high quality results
■ Dense web construction (9 density)	■ Starting point for deburring, blending, polishing and finishing applications
■ More open web construction (7 density)	■ Smear-resistant and cool cutting on light deburring applications
■ Waterproof	■ Use dry, wet or with oil
■ Non-metallic	■ No contamination of workpiece
■ Optimum grain/resin formulation	■ Durable, long life construction with versatile application range and improved cut rate and shed resistance
■ Conformable and flexible	■ Less operator fatigue

AVAILABILITY

TIER:	BETTER
BRAND:	Norton
TRADENAME:	SERIES 1000 LONG LIFE RAPID FINISH CONVOLUTE WHEELS

SIZE (D x T x H)	ABRASIVE	GRIT	MAX. RPM	STD. PKG.	7 DENSITY PART #	8 DENSITY PART #	9 DENSITY PART #
Series 1000 Long Life Rapid Finish Convolute Wheels							
6 x 1/2 x 1	A/O	M	6,000	4	66261018857	66261018789	66261018650
	S/C	M	6,000	4			66261019540
	S/C	F	6,000	4	66261018628		66261018629
6 x 1 x 1	A/O	M	6,000	3	69957397884	66261018636	66261019337
	S/C	M	6,000	3	69957397882	69957397883	66261018630
	S/C	F	6,000	3	66261018631	66261018774	66261018632
8 x 1 x 3	A/O	M	4,500	3	69957397885	66261018855	66261018633
	S/C	M	4,500	3	69957394610	66261018673	66261018997
	S/C	F	4,500	3	66261018639	66261018640	66261018641
12 x 1 x 5	A/O	M	3,000	2	69957397887		66261018896
	S/C	M	3,000	2		66261018786	66261018908
	S/C	F	3,000	2			66261018626



LIGHT FINISHING CONVOLUTE WHEELS
 BEST CHOICE FOR LIGHT DEBURRING, POLISHING, AND FINE FINISHING APPLICATIONS

FEATURES	BENEFITS
■ Controlled cut rate	■ Prevents "over benching"
	■ Deburrs and polishes without altering geometry
■ Very conformable	■ Operator friendly, reduces fatigue
■ Superior form holding	■ Consistent, reliable edge breaking and finishing with minimal wheel dressing and reshaping
	■ Less dust and shedding with more uniform wear
■ Durable resin bond system	■ Substantial extended wheel life in a soft, conformable wheel
■ Advanced manufacturing process	■ Improved web forming and grain distribution produce consistent finish on intricate polishing applications

AVAILABILITY

TIER:	BEST
BRAND:	Norton
TRADENAME:	LIGHT FINISHING CONVOLUTE WHEELS

SIZE (D x T x H)	ABRASIVE	GRIT	MAX. RPM	STD. PKG.	6 DENSITY PART #	7 DENSITY PART #	8 DENSITY PART #
Light Finishing Convolute Wheels							
6 x 1/2 x 1	S/C	F	6,000	4	66261092322	66261092324	66254421572
6 x 1 x 1	S/C	F	6,000	3	66254403708	66254403709	66254421573
8 x 1/2 x 3	S/C	F	4,500	4	66254403707	66254409698	66254421575
8 x 1 x 3	S/C	F	4,500	3	66261095702	66254409924	66254421577

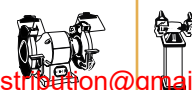

Convolute Wheels CONTINUED



METAL FINISHING CONVOLUTE WHEELS

BEST CHOICE FOR DECORATIVE FINISHING, BLENDING, AND FINAL FINISHING

FEATURES	BENEFITS
■ Premium, medium grit aluminum oxide grain	■ Generates uniform distinct satin and antique finishes
■ Dense, very durable web	■ Can be used for blending applications
■ Strongest resin binders	■ Resilient, long life construction
■ Uniform grain dispersion and coating	■ Clean and condition without gouging or changing dimensions of workpiece
■ Available in 5 and 6 densities	■ Ideal for blending and matching #3 and 4 mil. finishes, and surface prep for buffing, polishing and applying decorative finishes

AVAILABILITY

TIER:	BEST
BRAND:	Norton
TRADENAME:	METAL FINISHING CONVOLUTE WHEELS

SIZE (D x T x H)	ABRASIVE	GRIT	DENSITY	MAX. RPM	STD. PKG.	PART #
Metal Finishing Convolute Wheels						
6 x 1 x 1	A/O	M	5	6,000	3	66261007936
		M	6	6,000	3	66261010148
6 x 2 x 1	A/O	M	5	6,000	2	66261007957
		M	6	6,000	2	66261009635
8 x 1 x 3	A/O	M	5	4,500	3	66261007831
8 x 2 x 3	A/O	M	5	4,500	2	66261007904
		M	6	4,500	2	66261012971
12 x 1 x 5	A/O	M	5	3,000	2	66261007434
		M	6	3,000	2	66261009481
12 x 2 x 5	A/O	M	5	3,000	1	66261007212
14 x 2 x 8	A/O	M	5	2,550	1	66261007817
		M	6	2,550	1	66261012041



CLEAN & FINISH CONVOLUTE WHEELS

BEST CHOICE FOR FINE FINISHING WITH LIGHT PRESSURE

FEATURES	BENEFITS
■ Silicon carbide grain	■ Good for blending, rust removal, applying decorative, contrast finishes and low- to moderate-speed applications
	■ Not used for deburring
■ Open mesh construction	■ Used with light to moderate pressure, low speed

AVAILABILITY

TIER:	BEST
BRAND:	Norton
TRADENAME:	CLEAN & FINISH CONVOLUTE WHEELS

SIZE (D x T x H)	ABRASIVE	GRIT	DENSITY	MAX. RPM	STD. PKG.	PART #
Clean & Finish Convolute Wheels						
4 x 1 x 1	S/C	M	4	4,000	10	66261058502
		F	4	4,000	10	66261058501
6 x 1 x 1	S/C	M	4	3,000	4	66261058507
		F	4	3,000	4	66261058506
6 x 2 x 1	S/C	M	4	3,000	2	66261058510
		F	4	3,000	2	66261058509
6 x 3 x 1	S/C	M	4	3,000	1	66261058512
6 x 4 x 1	S/C	M	4	3,000	1	66261058514
8 x 1 x 3	S/C	M	4	2,500	3	66261058518
8 x 2 x 3	S/C	M	4	2,500	2	66261058521
8 x 3 x 3	S/C	M	4	2,500	1	66261058524
8 x 4 x 3	S/C	M	4	2,500	1	66261058526





Aluminum Reducing Bushings for Flap and Convolute Wheels



- Durable, aluminum one-piece-design flanges with integrated “contact washer”
- Snug fit; extended usable life
- Available in stock and non-stock sizes: 3" up to 10" in many combinations of ID hole reduction

WHEEL CENTER HOLE	BUSHING REDUCES HOLE SIZE TO	FOR WHEEL DIAMETER	STD. PKG.	PART #
Aluminum Reducing Bushing for Flap and Convolute Wheels				
1	3/8	4 - 6	1 Pair	66261080522
	1/2	4 - 6	1 Pair	66261080523
	5/8	4 - 6	1 Pair	66261080524
	3/4	4 - 6	1 Pair	66261080525
	7/8	4 - 6	1 Pair	66261080526
2	1/2	6	1 Pair	66261080527
	5/8	6	1 Pair	66261080528
	1	6	1 Pair	66261080529
	1-1/4	6	1 Pair	66261080530
3	1	8	1 Pair	66261080531
	1-1/4	8	1 Pair	66261080532
	1-1/2	8	1 Pair	66261080383
	2	8	1 Pair	66261080514
5	1	10 and 12	1 Pair	66261080533
	1-1/4	10 and 12	1 Pair	66261080534
	3	10 and 12	1 Pair	66261080535
8	1-1/4	14	1 Pair	66261080536
10	1-1/4	16	1 Pair	66261080520





CATEGORY DEFINITION

Norton non-woven belts are a combination of strong synthetic mesh and quality abrasive, bonded together by a smear-resistant adhesive. The open construction of non-woven material enables aggressive cutting action and improved surface finish while maintaining its non-loading feature.

APPLICATIONS: Removing surface defects, light edge burrs, parting lines, flashing, rust, oxides, corrosion, paints, and scale; blending mill marks, tool marks, uneven edges, and applying decorative finishes.

ABRASIVE GRAIN: Aluminum Oxide

GRIT RANGE: Extra Coarse (Black), Coarse (Brown), Medium (Maroon), Fine (Green), Very Fine (Blue)

APPLICATION/GRIT RECOMMENDATION GUIDE

	EXTRA COARSE	COARSE	MEDIUM	FINE	VERY FINE
	BETTER CHOICE - NORTON VORTEX RAPID PREP				
	GOOD CHOICE - NORTON RAPID PREP				
Scale Removal	X				
Stock Removal		X			
Heavy Deburring		X			
Light Deburring			X		
Light Finishing			X		
Blending				X	
Finishing					X

FEATURED PRODUCTS



NORTON VORTEX RAPID PREP NON-WOVEN BELTS

BETTER CHOICE FOR FINISHING AND BLENDED APPLICATIONS

FEATURES

- Proprietary Vortex aluminum oxide abrasive grain and new coating method
- Clean Bond resin system, aerospace-tailored

BENEFITS

- Most consistent cutting and finishing of surface conditioning products on the market
- Combine maximum cutting speed with the finish of fine grits
- Reduce process times by 50+% by eliminating 2 to 5 grit sequences to 1 step in your technical blending operations
- More resistant to edge wear; up 4X life vs. competitive products
- Friable grain structure keeps Ra specs throughout disc life and reduces scrap and rework
- Smear-free, even on high nickel content alloys
- Will not load on aluminum and soft metals, as competitive products may



NORTON RAPID PREP

GOOD CHOICE FOR FINISHING AND BLENDED APPLICATIONS

FEATURES

- Clean Bond resin system, aerospace-tailored
- Proprietary new coating method
- Extended form holding

BENEFITS

- Smear-free, even on high nickel content alloys
- Will not load on aluminum and soft metals, as competitive products may
- Thick layer of grain throughout the product extends life; grain does not sit on top of fibers as other competitive products may
- Lowest total cost of consumable tooling per workpiece
- 50% better life than competitive aluminum oxide products



Norton Vortex Rapid Prep

AVAILABILITY

TIER:			BETTER	BETTER	BETTER	BETTER	BETTER
BRAND:			Norton	Norton	Norton	Norton	Norton
TRADENAME:			VORTEX RAPID PREP	VORTEX RAPID PREP	VORTEX RAPID PREP	VORTEX RAPID PREP	VORTEX RAPID PREP
ABRASIVE:			Aluminum Oxide	Aluminum Oxide	Aluminum Oxide	Aluminum Oxide	Aluminum Oxide
GRIT/COLOR:			EXTRA COARSE	COARSE	MEDIUM	FINE	VERY FINE
WIDTH	LENGTH	STD. PKG.	PART #	PART #	PART #	PART #	PART #
2	18-15/16	12	66623313274	66623335031	66623333675	66623333649	66623333688
2-3/4	15-1/2	10	66623333718	66623333628	66623333676	66623333655	66623333694
3	10-11/16	12	66623333719	66623335039	66623335110	66623333656	66623333695
	18	10	66623335149	66623335040	66623335112	66623333657	66623335135
	21	10	66623333720	66623333629	66623335113	66623333658	66623333696
	24	10	66623335150	66623333630	66623335114	66623333659	66623335136
3-1/2	15-1/2	8	66623333725	66623335042	66623335118	66623333665	66623335139
4	24	8	66623333726	66623335043	66623335119	66623333666	66623333700

Norton Rapid Prep

AVAILABILITY

TIER:			GOOD	GOOD	GOOD	GOOD	GOOD
BRAND:			Norton	Norton	Norton	Norton	Norton
TRADENAME:			RAPID PREP	RAPID PREP	RAPID PREP	RAPID PREP	RAPID PREP
ABRASIVE:			Aluminum Oxide	Aluminum Oxide	Aluminum Oxide	Aluminum Oxide	Aluminum Oxide
GRIT/COLOR:			EXTRA COARSE	COARSE	MEDIUM	FINE	VERY FINE
WIDTH	LENGTH	STD. PKG.	PART #	PART #	PART #	PART #	PART #
1/4	18	24		66261011420	66261012524	66623333424	66623333511
	24	24		69957392606	66261097565	66623333425	66623333512
1/2	12	24		66261003177	66261006465	66623318175	66254499884
	18	24		66261055309	66261055310	66623333426	66261055311
	24	24		66261055312	66261008972	66254490859	66261019876
3/4	18	12		66261002111	66261015808	66254490858	66261003622
	20-1/2	12		66261083899	66261003260	66623333427	66623333515
	80	12		66623333411	66623333505	66623333428	66623333516
1	18	12		66261007023	66261017898	66623333429	66623333518
	21	12		66623333412	666233336005	66623333430	66623333519
	30	12		66261019801	66623336006	66623333431	66261001972
	42	12		66261008317	66254441289	66623333432	66623333521
	60	12		66623333413	66623333506	66623333433	66261055412
	64	12		66623333414	66623301513	66623333434	66261055413
	72	12		66261194240	66261006378	66254493830	66261005583
	132	10		66623314981	66261011414	66254436886	66623333525
1-1/2	60	8		66623333415	66261007644	66623333435	66623303624
2	18-15/16	12	66261018226	66261018224	66623333507	66623333436	66623333528
	34	12		66261063309	66623312203	66623333437	66623333529
	48	10		66261006504	66261006648	66623333438	66623333531
	60	8		66623333416	66261189669	66623333439	66623333532
	72	8		66261002571	66261007757	66623333440	66261002307
	132	6		66261008491	66261008492	66261069525	66623333533
2-1/2	60	6		66254429365	66254441491	66623333441	66623333534
2-3/4	15-1/2	10		66623333417	66623333508	66623333442	66623333535
3	10-11/16	12	66623333580	66261018076	66261067469	66623333443	66623333536
	18	10	66254428772	66254496043	66254428776	66623333444	66261019836
	21	10	66623333584	66623333418	66261010870	66623333445	66623333537
	24	10	66254433359	66623314158	66254428773	66623333446	66261055593
	72	6		66623333419	69957396833	66623333447	66261003176
	80	4		66623333420	66261007149	66623333448	66623333542
	90	4		66623333421	66623333509	66623333449	66623333541
	118	4		66623333422	66623333510	66623333450	66261047121
	132	4		66254490470	66261055322	66623333451	66623333543
3-1/2	15-1/2	8	66623333595	66261055324	66254444576	66623333452	66261055326
4	24	8	66623333596	66254495931	66261031667	66623333453	66623333545
	36	6		66623333423	66261002321	66623333454	66623333546
	132	2		66261009056	66261006898	66623333455	66623333547
	168	2		63642576650	66261009174	66623333456	66623333548
	48	4		66261055330	66261055331	66623333457	66261055332

If you do not see the Rapid Prep belts you need in our stock offering, call your local Norton distributor to check for made-to-order availability.

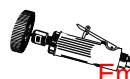

CATEGORY DEFINITION

Non-woven surface finishing flap wheels are an ideal choice for a wide variety of blending and finishing applications common in the metal fabrication, welding and polishing industries. Flap wheels are conformable to intricate shapes and contours. Designed to deliver a consistent finish with a uniform rate of cut, flap wheels wear away continually exposing fresh abrasives.

There are two types of non woven flap wheels: non-woven only abrasive flaps where finishing is the primary application, and interleaf with alternating cloth and non-woven abrasive flaps (less conformable, more aggressive) for stock removal and finishing. Interleaf flap wheels must always be run in the direction indicated by the arrow.

APPLICATIONS: Used for a wide range of metal fabrication and welding applications including blending, deburring, cleaning, finishing, and polishing

SIZE RANGE: Flap wheels with mounted steel shanks: 2" – 4" diameter
Flap wheels with arbor holes: 3" – 12" diameter

GRIT RANGE: 60 – 320

ABRASIVE GRAIN: Aluminum Oxide, Silicon Carbide

APPLICATION/GRIT RECOMMENDATION GUIDE

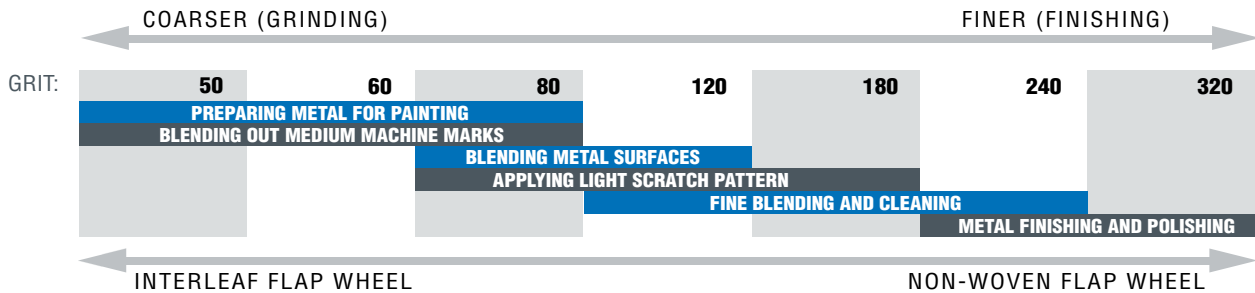



1/4" Mounted Steel Shanks

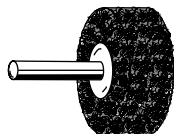

AVAILABILITY

TIER:
BRAND:
TRADENAME:



BETTER	GOOD	BETTER	GOOD
Norton	Merit	Norton	Merit
INTERLEAF	INTERLEAF	NON-WOVEN	NON-WOVEN

SIZE (D x W x SK.)	ABRASIVE	CA GRIT	NON-WOVEN GRIT	MAX. RPM	STD. PKG.	PART #	PART #	PART #	PART #
2 x 1 x 1/4	A/O	60	Coarse	12,000	10	66261051720*	08834138122		
	A/O	80	Medium	12,000	10	66261051721*	08834138123		
	A/O	120	Medium	12,000	10	66261051722	08834144457	66261051716*	66261189992*
	A/O	180	Fine	12,000	10		08834144458		
	A/O	320	Very Fine	12,000	10		08834144459	66261051717*	69957399202
2 x 1-1/2 x 1/4	A/O	60	Coarse	12,000	10		08834138124		
	A/O	80	Medium	12,000	10		08834138125		
	A/O	120	Medium	12,000	10		08834138126		
	A/O	180	Fine	12,000	10		08834138127		
	A/O	320	Very Fine	12,000	10		08834138128		
3 x 1 x 1/4	A/O	60	Coarse	12,000	10		08834138129		
	A/O	80	Medium	12,000	10		08834138130		
	A/O	120	Medium	12,000	10	66261051725*	08834138118	66261051718*	08834131921
	A/O	180	Fine	12,000	10		08834138120	66261051719*	
	A/O	-	Very Fine	12,000	10		08834138119		
3 x 1-3/4 x 1/4	A/O	-	Medium	12,000	10				66261026075
3 x 2 x 1/4	A/O	60	Grit	8,000	10		08834131338		
	A/O	80	Coarse	8,000	10		08834138116		
	A/O	120	Medium	8,000	10		08834144460	66261058474	
	A/O	180	Medium	8,000	10		08834144461		
4 x 2 x 1/4	A/O	80	Coarse	12,000	10		08834121115		
	A/O	120	Medium	12,000	10		08834120458		

SOME MERIT PART NUMBERS ARE NON-STOCK. ASK YOUR NORTON/MERIT REPRESENTATIVE FOR STOCK/MTO STATUS.
*STANDARD PACKAGE QUANTITY = 20

Refer to Non-Woven Convolute Wheel section for Flap Wheel Reducing Bushings.



BEAR-TEX

Arbor Hole Mounts

AVAILABILITY



TIER:
BRAND:
TRADENAME:

BETTER	GOOD	BETTER	GOOD
Norton	Merit	Norton	Merit
INTERLEAF	INTERLEAF	NON-WOVEN	NON-WOVEN

SIZE (D x W x SK.)	ABRASIVE	CA GRIT	NON-WOVEN GRIT	MAX. RPM	STD. PKG.	PART #	PART #	PART #	PART #
3 x 2 x 3/8	A/O	60	Coarse	12,000	10		08834139000		
	A/O	120	Medium	12,000	10		08834139001		
	A/O	240	Very Fine	12,000	10		08834139028		
	A/O	320	Very Fine	12,000	10		08834139024		
4 x 2 x 5/8	A/O	60	Coarse	12,000	10		08834126025		
	A/O	240	Very Fine	12,000	10		08834126014		
	A/O	320	Very Fine	12,000	10		08834126027		
6 x 1 x 1	A/O	120	Medium	6,000	10		08834126006		
	A/O	240	Very Fine	6,000	10		08834126030		
6 x 1 x 2	A/O	80	Medium	3,000	4	66261004418			
	A/O	-	Medium	3,000	4			66261058456	
	A/O	180	Fine	3,000	4	66261005387		66261058487	05539562635
	S/C	-	Fine	3,000	4			66261058451	
6 x 2 x 1	A/O	80	Medium	6,000	10		08834126009		
	A/O	180	Fine	6,000	10		08834126018		
6 x 3 x 1	A/O	80	Medium	6,000	6		08834126055		
8 x 1 x 3	A/O	120	Medium	2,500	3	66261010711			
	-	-	Fine	2,500	3			66261058491	
8 x 2 x 1	A/O	120	Medium	4,500	6		08834126043		
	A/O	180	Fine	4,500	6		08834126044		
8 x 2 x 3	A/O	-	Medium	2,500	2			66261000889	
	A/O	-	Medium	2,500	2				05539512677
	A/O	-	Fine	2,500	2			66261058493	
12 x 1 x 5	A/O	80	Medium	1,900	2	66261010712			
12 x 2 x 5	A/O	-	Medium	1,900	1				05539528945
	A/O	-	High Strength	1,900	1			66261005070	05539562637

SOME MERIT PART NUMBERS ARE NON-STOCK. ASK YOUR NORTON/MERIT REPRESENTATIVE FOR STOCK/MTO STATUS.



Introduction

Most Norton Bear-Text products consist of a non-woven web of nylon fibers impregnated throughout with abrasive grain and bonded with synthetic resins. This design produces a cushioned, three-dimensional material that is extremely pliable and long lasting. The uniform dispersion of abrasive throughout the web provides a continuous supply of new grain as the old grain and fibers wear away during use. Norton Bear-Text products, with their open mesh construction, are waterproof, washable, resilient, conformable, non-loading, non-conductive, non-metallic and non-rusting. Norton Bear-Text wheels are easily pre-formed to conform to special-shaped work pieces.

Since Norton Bear-Text products are designed for use where stock removal is not required, they begin where other abrasives leave off. The relatively non-aggressive nature of nylon and grit inherent in the Norton Bear-Text material makes it ideal as a finishing tool. While 60 to 80 grit are considered intermediate sizes in other products, they are considered coarse for Norton Bear-Text items.

Used wet or dry, Norton Bear-Text products offer the following advantages: controlled cut (with little or no stock removal) allows for increased productivity, consistent, uniform finish, ability to automate operations, minimized smearing and reduced operator training. These advantages make Norton Bear-Text products an excellent alternative to bristle brushes, set-up wheels, greaseless compounds and steel wool.

Product Identification System

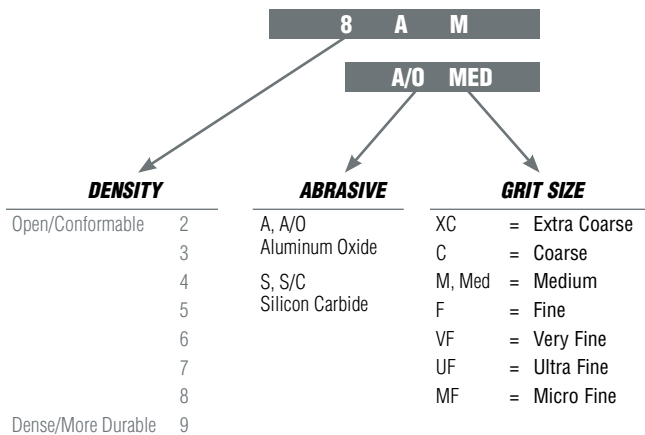

Abrasives

Silicon carbide and aluminum oxide abrasives are offered. Silicon carbide is sharper, cuts faster, and produces finer scratch patterns on most surfaces. Aluminum oxide is more durable and tends to last longer. It causes less discoloration on aluminum, and is more aggressive on certain applications such as hardened steel parts. Norton Bear-Text hand pads are also available in a non-abrasive material.

Grits

Grit refers to the size of the abrasive grain impregnated into the nylon web. The coarser the grit, the more aggressive the cut, the rougher the finish. The finer the grit, the less aggressive the cut and the resulting surface finish will be finer, if all other conditions are equal.

GRIT DESIGNATIONS	GRIT SIZE
Extra Coarse (XC)	24 – 36
Coarse (C)	50 – 80
Medium (M)	100 – 150
Fine (F)	180 – 220
Very Fine (VF)	240 – 360
Super Fine (SF)	400
Ultra Fine (UF)	600
Micro Fine (MF)	800 – 1200

Densities

The product “density” refers to the number of fibers which have been compressed into the nylon web material. Under identical conditions, harder density wheels cut faster, last longer and produce finer finishes than softer density wheels. Softer density wheels offer greater conformability and have less tendency to load or burn the work piece.

Fiber Sizing

Several nylon fiber sizes are used in the manufacture of Norton Bear-Text web material because the fiber size is a significant factor in the coating process, as each produces distinct cutting characteristics.

Bonding Agents

Waterproof resins are used in the manufacture of Norton Bear-Text web material to bond the nylon fibers together and to firmly anchor the abrasive grains throughout the web.

Conventional Finishing Methods Versus Norton Bear-Text Products

The following chart outlines the advantages achievable when using Norton Bear-Text products as alternatives to other cleaning, blending, deburring and finishing methods.

Norton Bear-Text products are listed in the sequence of normal preference for the application stated. However, because of the numerous variables, only testing can ensure selection of the most cost-effective product.

CONVENTIONAL FINISHING METHOD	KEY APPLICATION	BEAR-TEXT PRODUCT AS AN ALTERNATIVE	ADVANTAGES OF BEAR-TEXT PRODUCT VERSUS ALTERNATE FINISHING METHODS
Bristle Brushes	Cleaning	Clean & Finish Wheels Metal Finishing Wheels Flap Wheels	Superior cleaning performance Higher productivity No slurry or compound required More consistent finish Eliminate compound dust
Greaseless Compounds	Finishing	Flap Wheels Convolute Wheels Unified Wheels	Reduced maintenance No compound, instant set-up Elimination of compound dust More uniform finish More consistent work rate
Set-up Wheels	Blending/ Deburring	Convolute Wheels Unified Wheels	No break-in time required More consistent cut More uniform finish Maintain geometry Safer, no flying wheel pieces
Steel Wool	Cleaning	Rolls Discs Hand Pads	Faster, longer life Less pressure required Non-rusting, cleaner Safer, no splinters

Getting the Most Out of Norton Bear-Tex Wheels

Maximum wheel life and best surface conditioning results can be achieved by closely adhering to the following recommendations.

1) Wheel Direction

Convolute wheels and interleaf flap wheels must always run in the direction indicated by the arrow printed on the side of each wheel. Conventional flap wheels and unified wheels can be run in either direction.

2) Wheel Speed

Wheel speed is an important factor in that it affects product finish, rate of cut, and wheel life. In general, fast wheel speeds give harder action and a finer finish; whereas, slower speeds give a softer action and a coarser finish for the same wheel density.

The following are recommended operating speeds for the most common applications.

APPLICATION	RECOMMENDED SPEED
Cleaning and upgrading of surface conditions	2200 to 6000 SFPM
Cut-buffing on metal surfaces	6500 to 8000 SFPM
Deburring	5500 to 8000 SFPM
Decorative finishing	500 to 3000 SFPM
Imparting decorative finishes	900 to 3000 SFPM
Oxide removal	3500 to 6500 SFPM

TESTING MIGHT SHOW THAT A SLOWER OR FASTER SPEED IS DESIRABLE FOR SPECIFIC OPERATIONS. NEVER EXCEED THE MAXIMUM RPM RATING OF THE WHEEL.

3) Pressure

Light to medium pressure is recommended for most operations. Flap wheels require much lighter pressure to perform properly than other Norton Bear-Tex wheels; unified wheels can withstand much higher pressures in order to perform deburring jobs. In all cases, avoid excessive pressure which may result in wheel deformation and damage to the work surface.

4) Feed Speed

Low feed speed reduces the number of workpieces completed, while producing a shorter scratch pattern. Slow feed speed allows for longer dwell time and permits more work to be done on each piece. Conversely, a fast feed speed increases the number of workpieces completed, while producing a longer scratch pattern.

5) Oscillation

Oscillation may be used to break up scratch lines and produce a more uniform finish. Additionally, an increase in cut may be experienced. A general starting point for oscillation is 3/8" amplitude at 200 cycles per minute.

6) Lubricants

Lubricants, such as water, water soluble oil, and straight oil, will decrease the heat generated while running, improve the luster, and reduce the surface finish. The higher the viscosity of the lubricant, the lower the surface finish (RMS value) produced.

Factors in Wheel Choice

This chart provides a relative comparison of other Norton Bear-Tex wheel variables. It can serve as a useful guide in choosing the most suitable product for a given application. However, as many other factors affect wheel performance, this chart can only be general in nature. The most cost-effective results can always be obtained by wheel testing on the application.



* ON STEEL SURFACES, SILICON CARBIDE WHEELS WILL PRODUCE A BRIGHTER FINISH THAN ALUMINUM OXIDE WHEELS.

Surface Finish Variables

Changes in any one of many factors can affect the surface finish on the work piece. This chart shows the effect on surface finish by changes in single factors of product specifications. Arrows have been used to signify the trend direction. The arrow length does not signify that the effect of each factor is equal.

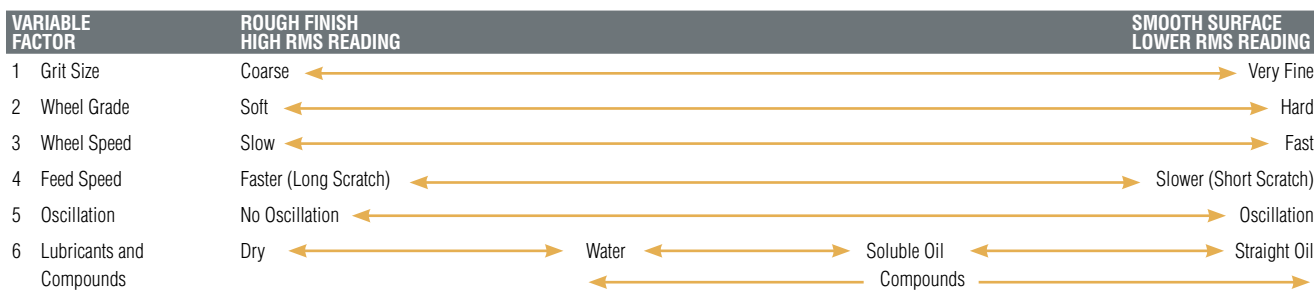



complementing our **ABRASIVES PORTFOLIO**

To help you finish the job, Norton accessory items let you one-stop shop. Our goal is to get it finished faster, easier and with less hassle of multiple vendors and invoices.



Get Wired

Broad wire brush offering includes the basic shapes and configurations you'll need for heavy - to light-duty brushing applications.



The Right Dose of Fiber

Trap dirt, grime or liquids with microfiber cloths. Whether you are cleaning, dry tacking, or polishing, these cloths make quick work, trapping all unwanted particles.



Unmasking the Mystery

Masking tape choices: Professional High Heat for maximum performance and clean release on multiple surfaces; Blue Core 14-Day Tape for easy on/off. and Pro Contractor Grade for general purpose.

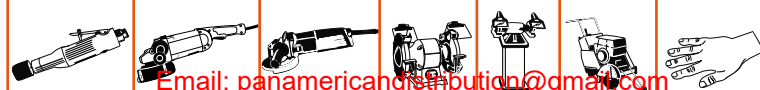

CATEGORY DEFINITION

Our Norton wire brush broad offering includes all the basic shapes and configurations: cups, saucer cups, wheel end brushes and hand brushes. Informative, attractive packaging clearly explains dimensions, structure, safety and machine usage. All brushes are individually clamshell packaged unless otherwise noted. When using wire brushes, be sure to comply with ANSI B165 "Power-Driven Brushing Tools: Safety Requirement for the Design, Care and Use." and safety documents on www.nortonabrasives.com website.

- APPLICATIONS:** Cleaning rust, scale and dirt; light deburring; edge blending; roughening for adhesion; finishing for appearance; finish preparation prior to plating or painting
- SHAPES:** Cup, saucer cup, wheel, end brush, hand brush
- WIRE DESIGN:** Twisted knot, crimped, and stringer bead
- OTHER:** Color-coded for easy identification: STAINLESS STEEL/METAL

FEATURED PRODUCTS AND AVAILABILITY

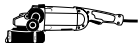

BETTER TWIST KNOT WIRE SAUCER CUP BRUSHES

IDEAL FOR CLEANING CORNERS, RECESSES, AND OTHER HARD-TO-REACH AREAS – FOR STEEL/STAINLESS

FEATURES

- Twist knot style

BENEFITS

- For heavy-duty cleaning

DIAMETER x WIRE THICKNESS x MOUNT	MAX. RPM	STD. PKG.	APPLICATION	PART #
4 x .020 x 5/8-11	15,000	5	Carbon	66252833483
5 x .020 x 5/8-11	12,500	10	Carbon	66252835585
5 x .020 x 5/8-11	12,500	10	Stainless	66252835586

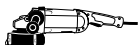

BETTER HIGH PERFORMANCE (HP) CABLE CRIMPED CUP BRUSHES

FOR LIGHT- TO MEDIUM-DUTY BRUSHING APPLICATIONS ON FLAT OR IRREGULAR SURFACES, AND BEVEL BUFFING – FOR STEEL

FEATURES

- 12 wires of .009" brass-coated steel are bundled together into a group, then crimped
- Cable crimped wire breaks down in smaller pieces than standard crimped brushes

BENEFITS

- Creates a 50% longer lasting brush compared to standard crimped brushes; better flexibility on irregular surfaces
- Safer wire to use
- Protective guard

DIAMETER x WIRE THICKNESS x MOUNT	MAX. RPM	STD. PKG.	APPLICATION	PART #
Crimped Cup with Protective Guard – Single Row				
3 x (12 x .009) x 5/8-11	15,000	5	Carbon	66252833493
4 x (12 x .009) x 5/8-11	9,000	5	Carbon	66252833494

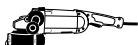

BETTER CRIMPED WIRE CUP BRUSHES

FOR LIGHT- TO MEDIUM-DUTY BRUSHING APPLICATIONS ON FLAT OR IRREGULAR SURFACES, AND BEVEL BUFFING – FOR STEEL

FEATURES

- Highly flexible heavy wire fill

BENEFITS

- Fast cutting

DIAMETER x WIRE THICKNESS x MOUNT	MAX. RPM	STD. PKG.	APPLICATION	PART #
3 x .014 x 5/8-11	15,000	5	Carbon	69936653341
3 x .014 x 5/8-11	20,000	5	Stainless	66252836362
4 x .014 x 5/8-11	9,000	5	Carbon	69936653347
4 x .020 x 5/8-11	9,000	5	Stainless	66252843844
6 x .014 x 5/8-11	6,000	5	Carbon	69936653348
6 x .020 x 5/8-11	6,000	1	Carbon	69936653349

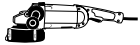

FEATURED PRODUCTS AND AVAILABILITY

**BETTER TWIST KNOT WIRE CUP BRUSHES**

HIGH IMPACT CUTTING AND CLEANING ON MORE DEMANDING APPLICATIONS – FOR STEEL/STAINLESS

FEATURES

- Rigid structure
- Available with or without plastic guard
- Protective guard opens up into a shield
- Single row construction
- Double row construction

BENEFITS

- High impact cutting and cleaning on more demanding applications
- Application-specific
- Prevents wire, dust and/or projection from reaching the end-user
- Provides for a friendly handling of the brush, preventing potential pricking caused by the wire ends
- Limits flaring of the brush on corners and angles
- More aggressive; provides twice the cutting points of a single row cup brush for heavy-duty action in very severe applications

DIAMETER x WIRE THICKNESS x MOUNT	MAX. RPM	STD. PKG.	APPLICATION	PART #
Knotted Cup With Protective Guard – Single Row				
2-3/4 x .020 x 5/8-11	15,000	5	Carbon	66252833492
4 x .020 x 5/8-11	9,000	5	Carbon	66252833496
5 x .020 x 5/8-11	6,500	5	Carbon	66252833497
Knotted Cup – Single Row				
2-3/4 x .020 x 5/8-11	15,000	5	Carbon	69936653336
2-3/4 x .020 x 5/8-11	15,000	5	Stainless	69936653340
4 x .020 x 5/8-11	9,000	5	Carbon	69936653345
4 x .020 x 5/8-11 with bridle	9,000	5	Carbon	66252833947
6 x .020 x 5/8-11	6,000	5	Carbon	69936605965
6 x .035 x 5/8-11	6,000	5	Carbon	69936602003
Knotted Cup – Double Row				
6 x .020 x 5/8-11	6,000	5	Carbon	69936653346

BETTER CRIMPED WIRE WHEEL BRUSHES

EXCELLENT PERFORMANCE FOR DEBURRING, REMOVING RUST, CORROSION AND DIRT – FOR STEEL

FEATURES

- Brushes may be used individually or stacked on a shaft
- Single-section, narrow-faced brushes are ideal for general-purpose brushing of uneven or difficult-to-reach surfaces
- Single section, medium-faced brushes clean larger surface areas and have longer life

BENEFITS

DIAMETER x WIRE THICKNESS x HOLE SIZE	MAX. RPM	STD. PKG.	APPLICATION	PART #
Crimped Narrow 3/4" Face				
6 x .014 x 1/2-2**	6,500	5	Carbon	69936653306
Crimped Medium 1" Face				
4-1/2 x .014 x 5/8-11	13,000	6	Carbon	66253370278
6 x .014 x 1/2-2**	6,500	5	Carbon	69936653324
8 x .014 x 1/2-2**	4,500	5	Carbon	69936653326

** 7 BUSHING SIZES INCLUDED WITH EACH BRUSH (FIT 1/2" - 2")

STAINLESS

STEEL/METAL



FEATURED PRODUCTS AND AVAILABILITY

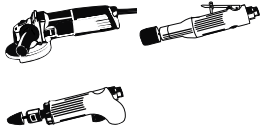

BETTER STANDARD TWIST KNOT WIRE WHEEL BRUSHES

IDEAL FOR TOUGHER WELDING AND METAL FABRICATION APPLICATIONS (REMOVING WELD SCALE SPATTER, EXTRA-HEAVY RUST AND CORROSION, OR SURFACE ROUGHENING) – FOR STEEL/STAINLESS

FEATURES

- Twist knot wire design
- Pipeline: heavy-duty knot construction

BENEFITS

- Provides added rigidity for extra cutting and cleaning power
- Small diameter wheels are used for small- to medium-duty jobs requiring some flexibility and lighter brushing action
- Stiffer, longer-lasting knots for tougher applications / heavy build-up
- Longest life for brushing/cleaning joints and preparing expansion joints for filling and scaling

DIAMETER x WIRE THICKNESS x MOUNT/HOLE	MAX. RPM	STD. PKG.	APPLICATION	PART #
3 x .014 x 5/8-11	20,000	5	Stainless	66252836362
4-1/2 x .020 x 5/8-11	20,000	5	Carbon	69936606275
4 x .020 x 5/8-11	20,000	5	Carbon	66252838300
4-1/2 x .020 x 5/8-11	20,000	6*	Carbon Pipeline	66252840466
4-1/2 x .020 x 5/8-11	20,000	6*	Carbon	69936653331
4-1/2 x .020 x 5/8-11	20,000	5	Stainless	69936653333
5 x .020 x 5/8-11	12,500	5	Carbon	66252833487
5 x .020 x 5/8-11	12,500	5	Stainless	66252833488
6 x .020 x 5/8-11	12,500	5	Carbon	69936653352
6 x .020 x 5/8-1/2	12,500	5	Carbon	69936653327

*BULK PACKED ITEMS



EXPANDED OFFERING



BETTER STRINGER BEAD KNOT WIRE WHEEL BRUSHES

DELIVER HIGH-IMPACT CUTTING AND CLEANING FOR TOUGHEST APPLICATIONS – FOR STEEL/STAINLESS

FEATURES

- Stringer bead wire for hard-to-reach areas
- NEW! Heavy-Duty brushes
- Joint/Crack cleaning wire wheel brushes

BENEFITS

- Specially suited for groove and weld bead, corners, and t-connections
- 1/3 more welding points which provide 50% more resistance to side load pressure
- 6-7/8" brushes have 76 knots vs. standard 56 knot brushes, resulting in 40% more cleaning action and up to 2X life, with similar life for the smaller versions of the heavy-duty brushes
- Used for brushing joints, cleaning cracks in concrete and asphalt, and preparing expansion joints for filling and scaling
- Pipeline: longest life for brushing/cleaning joints and preparing expansion joints for filling and scaling

DIAMETER x WIRE THICKNESS x MOUNT	MAX. RPM	STD. PKG.	APPLICATION	PART #
For Right Angle Grinders				
4 x .020 x 5/8-11	20,000	5	Carbon	69936606277
4 x .020 x 5/8-11	20,000	6*	Carbon	66252833489
4 x .020 x 5/8-11	20,000	10*	Carbon	66253370022
4 x .020 x 5/8-11	20,000	6*	Carbon Pipeline	66252840467
4 x .020 x 5/8-11	20,000	5	Stainless	69936606278
4 x .020 x 5/8-11	20,000	6*	Stainless Pipeline	66252842233
4 x .020 x 5/8-11/M14-20	20,000	5	Carbon	66252840889
4-1/2 x .020 x 5/8-11	20,000	6	Carbon Heavy-Duty	66252844886
4-1/2 x .020 x 5/8-11	20,000	6*	Carbon Pipeline	66252842299
5 x .020 x 5/8-11	12,500	10*	Carbon	66252833490
5 x .020 x 5/8-11	12,500	10*	Stainless	66252833491
6 x .020 x 5/8-11	12,500	10*	Carbon	69936653350
6 x .020 x 5/8-11	12,500	10	Carbon Heavy-Duty	66252844887
6 x .020 x 5/8-11	12,500	10*	Carbon Pipeline	66252840469
6 x .020 x 5/8-11	12,500	10	Stainless	69936653351
6-7/8 x .020 x 5/8-11	9,000	10*	Carbon	69936653329
6-7/8 x .020 x 5/8-11	9,000	10*	Carbon Heavy-Duty	66252843919
6-7/8 x .020 x 5/8-11	9,000	10*	Carbon Pipeline	66252840468
9 x .020 x 5/8-11	6,000	6	Carbon	66252837993

For Walk-Behind Machines – Joint/Crack Cleaning Brushes

12 x .035 x 1 - DP	4,500	2	Carbon	69936606280
--------------------	-------	---	--------	-------------

*BULK PACKED ITEMS





FEATURED PRODUCTS AND AVAILABILITY



BETTER END BRUSHES

CLEAN AND DEBURR A RECESSED AREA OR THE INSIDE DIAMETER OF A TUBE OR PIPE – FOR STEEL/STAINLESS

FEATURES

- Twist knot wire end brushes
- Crimped wire end brushes

BENEFITS

- For more aggressive cutting
- For lighter brushing action and contoured surfaces



DIAMETER x WIRE THICKNESS x MOUNT	MAX. RPM	STD. PKG.	APPLICATION	PART #
Stem Mounted Knotted				
3/4 x .020 x 1/4 Shank	20,000	10*	Carbon	69936653316
1 x .014 x 1/4 Shank	20,000	10*	Carbon	69936606279
1 x .020 x 1/4 Shank	20,000	10*	Carbon	69936653310
Stem Mounted Crimped				
3/4 x .006 x 1/4 Shank	20,000	10*	Stainless	69936606145
3/4 x .014 x 1/4 Shank	20,000	10*	Carbon	69936653317
1 x .020 x 1/4 Shank	20,000	10*	Carbon	69936653309

*BULK PACKED ITEMS



BETTER HAND BRUSHES

FOR STEEL/STAINLESS

FEATURES

- Plastic handle scratch brush
- Long handle and shoe handle brushes

BENEFITS

- Ergonomic handle
- Crimped wire for longer life
- Wires are wrapped up and around the metal post so they never come out
- Curved face for hard-to-reach places
- Narrow brush allows access into tight areas and slots
- Steel scratch brushes are made with a high-carbon, brass-coated steel; stainless steel is made with a 304L stainless



SIZE	STD. PKG.	APPLICATION	PART #
Scratch Brush 3 x 19 Long Handle	12	Carbon	66252833948
Scratch Brush 3 x 19 Long Handle	12	Stainless	66252833950
Scratch Brush 4 x 16 Shoe Handle	12	Carbon	66252833949
Scratch Brush 4 x 16 Shoe Handle	12	Stainless	66252833951
Scratch Brush Plastic Handle	24	Carbon	66252833954
Scratch Brush Plastic Handle	24	Stainless	66252833953
Inspection Brush 3 x 7	36	Stainless	66252833952

STAINLESS
STEEL/METAL



CATEGORY DEFINITION

A micro-fiber is a single fiber with a thickness less than a human hair that has been split 16 times and woven into various products. The surface area of a micro-fiber product is increased over 15 times, creating millions of spaces between the fibers which trap dirt, grime or liquids, making this product one of the most absorbent materials. These cloths save you labor, time, and additional costs of multiple cleaning products and chemicals.

APPLICATIONS: Cleaning Cloth: Used for general-purpose wet or dry applications. Works best when sprayed with a light water mist to deep clean.

Dry Tack Cloth: This woven terry cloth has a low profile to resist snagging and help pick up embedded debris.

Polishing Cloth: Streak-free cleaning of mirrors, optical lens and highly-polished items.

OTHER: Color-coded for easy identification
 Cleaning Cloth: Blue
 Dry Tack Cloth: Red
 Polishing Cloth: Yellow

DESCRIPTION	COLOR	STD. PKG.	PART #
Micro-Fiber Cleaning Cloth			
16" x 16"	Blue	20	07660705300
Micro-Fiber Dry Tack Cloth			
16" x 16"	Red	20	07660704025
Micro-Fiber Polishing Cloth			
16" x 16"	Yellow	20	07660705301

TECHtip

- Use these micro-fiber cloths dry for general cleaning
- To remove spills, stains or grime, lightly dampen the cloth for best results
- All micro-fiber cloths can be used with or without chemicals
- Micro-fiber cloths can be washed up to 300+ times without losing cleaning and trapping abilities
- Clean often for best results



It is the user's responsibility to refer to and comply with all safety regulations.





Norton Premium Tan High Heat Tape

- Designed for maximum performance and clean release on multiple surfaces
- These high quality masking tapes are ideal for conditions that include exposure to the high heat curing temperatures found in automobile, truck, bus and other transportation assembly operations, as well as aerospace manufacturing applications
- Can be baked up to 230°F and be exposed to wet sanding without adhesive transfer
- Conforms easily to contours and irregular surfaces
- No bleed-through or flaking upon removal
- Available in bulk, accordion-wrapped for protection and work site stocking

SIZE (W x L)	STD. PKG.	PART #
Norton Premium Tan High Heat Tape		
18mm x 54.8m (3/4" x 60 yards)	48	63642506183
36mm x 54.8m (1-1/2" x 60 yards)	24	63642506184
48mm x 54.8m (2" x 60 yards)	24	63642506185

PACKED IN SLEEVES, WITH 4 SLEEVES TO A CASE



Norton Pro Contractor Grade Tape

- A general-purpose masking tape that offers both economy and versatility for a variety of materials and applications
- Norton Pro Contractor Grade masking tape provides a clean release up to 3 days
- Use for general paint masking, hanging protective plastic, holding drop cloths in place and other general-purpose masking, bundling, and sealing jobs where the tape will be removed when the job is complete
- Not intended for critical paint applications
- Limit exposure to UV light for extended periods
- Extended exposure to UV light could result in difficult removal from the surface

SIZE (W x L)	STD. PKG.	PART #
Norton Pro Contractor Grade Tape		
18mm x 54.8m (3/4" x 60 yards)	48	07660721944
36mm x 54.8m (1-1/2" x 60 yards)	24	07660721946
48mm x 54.8m (2" x 60 yards)	24	07660721947

BULK PACKED AS INDIVIDUAL ROLLS



Norton Blue Core 14-Day Tape

- Our premium paint masking tape has a specially formulated adhesive system that provides optimum low- to medium-tack adhesion and clean removal from a variety of surfaces, for up to 14 days
- Norton Blue Core masking tape can be used indoors or out
- The crepe paper backing is designed to enable easy unrolling and to minimize slivering
- It delivers very sharp, clean edges on smooth- to moderately-textured surfaces

SIZE (W x L)	STD. PKG.	PART #
Norton Blue Core 14 Day Tape		
18mm x 54.8m (3/4" x 60 yards)	48	07660721952
24mm x 54.8m (1" x 60 yards)	36	07660721953
36mm x 54.8m (1-1/2" x 60 yards)	24	07660721954
48mm x 54.8m (2" x 60 yards)	24	07660721955

BULK PACKED AS INDIVIDUAL ROLLS



your pathway **TO PRECISION PERFORMANCE**

Let us show you the way to maximize the performance with our precision line of form-holding vitrified toolroom grinding wheels with engineered excellence in either stock or make-to-order options.



NORTON **QUANTUM**

A Quantum Leap in Technology

A new generation of Norton Quantum ceramic abrasive products are designed for maximizing performance and cost savings in precision grinding.



NORTON **32A**

Sharper Versatility

Sharp monocrystalline aluminum oxide grain makes Norton 32A wheels the industry's most versatile abrasive; free cutting on full range of applications and materials.



NORTON **38A**

Cooler Cutting

White, friable abrasive grain delivers exceptionally cool cutting in light pressure, toolroom grinding applications with Norton 38A wheels.



CATEGORY DEFINITION

Used on surface, cylindrical, and tool and cutter grinders, Norton precision, form-holding vitrified toolroom wheels maximize your productivity. Available in latest-generation ceramic alumina, aluminum oxide, and silicon carbide – for every ferrous and nonferrous MRO, small job shop, and production operation.

- APPLICATIONS:** Surface grinding, tool and cutter grinding, and resharpening
- SHAPES:** Type 01 Straight, Type 02 Cylinder, Type 05 and 07 Recessed 1 and 2 Sides, Type 06 and 11 Straight and Flaring Cups, Type 12 Dish, Type 20 Concaved 1 Side, and Type 35 Plate Mounted Disc
- SIZE RANGE:** 2" – 18" diameter
- GRIT RANGE:** 46 – 220
- ABRASIVE GRAIN:** Ceramic Alumina, Aluminum Oxide, Silicon Carbide

MATERIAL-TO-PRODUCT RECOMMENDATION GUIDE

PERFORMANCE/PRODUCTIVITY APPLICATION / MATERIAL	NARROW CONTACT AREA			MEDIUM CONTACT AREA			WIDE CONTACT AREA		
	BEST	BETTER	GOOD	BEST	BETTER	GOOD	BEST	BETTER	GOOD
Tool Resharpening									
• Heavy Stock Removal (> .004) HSS & Tool Steel RC 50-68	5SG46-KVS	32A46-KVBE	38A46-KVBE	5SG46-JVS	32A46-JVBE	38A46-JVBE	5SG46-GVSP 3SGR46-GVP2	32A46-GVBEP 48A46-GVP2	38A46-GVBEP 38A46-GVP2
• Moderate Stock Removal (.002-.004) HSS & Tool Steel RC 50-68	5SG60-KVS	32A60-KVBE	38A60-KVBE	5SG60-JVS	32A60-JVBE	38A60-JVBE	5SG60-GVSP 3SGR60-GVP2	32A60-GVBEP 48A60-GVP2	38A60-GVBEP
Carbide			39C60-JVK			39C60-JVK			
Surface Grinding									
• Heavy Stock Removal (> .004) HSS & Tool Steel RC 50-68 400 Series Stainless Soft Steels RC 30-45 300 Series Stainless Cast Iron: Ductile & Gray	5NQ46-JVS	32A46-JVBE	38A46-JVBE	5SG46-IVS	32A46-IVBE	38A46-IVBE	5SG46-GVSP 3SGR46-GVP2	32A46-GVBEP 48A46-GVP2	38A46-GVBEP 38A46-GVP2
	5SG46-KVS	32A46-KVBE	38A46-KVBE	5SG46-JVS	32A46-JVBE	38A46-JVBE	5SG46-HVSP 3SGR46-HVP2	32A46-HVBEP 48A46-HVP2	38A46-HVBEP 38A46-HVP2
	5SG46-KVS	32A46-KVBE	38A46-KVBE	5SG46-JVS	32A46-JVBE	38A46-JVBE	5SG46-HVSP 3SGR46-GVP2	32A46-HVBEP 48A46-HVP2	38A46-HVBEP 38A46-HVP2
Nonferrous Alloys			39C46-JVK			39C46-IVK			
• Moderate Stock Removal (.002-.004) HSS & Tool Steel RC 50-68 400 Series Stainless Soft Steels RC 30-45 300 Series Stainless Cast Iron: Ductile & Gray	5NQ60-JVS	32A60-JVBE	38A60-JVBE	5SG60-IVS	32A60-IVBE	38A60-IVBE	5SG60-GVSP 3SGR60-GVP2	32A60-GVBEP 48A60-GVP2	38A60-GVBEP
	5SG60-KVS	32A60-KVBE	38A60-KVBE	5SG60-JVS	32A60-JVBE	38A60-JVBE	3SGR60-HVP2	32A60-HVBEP 48A60-HVP2	38A60-HVBEP 38A60-HVP2
	5SG60-KVS	32A60-KVBE	38A60-KVBE	5SG60-JVS	32A60-JVBE	38A60-JVBE	3SGR60-HVP2	32A60-HVBEP 48A60-HVP2	38A60-HVBEP 38A60-HVP2
Nonferrous Alloys			39C60-JVK			39C60-IVK			
• Light Stock Removal and Finishing (<.001) HSS & Tool Steel RC 50-68 400 Series Stainless Soft Steels RC 30-45 300 Series Stainless Cast Iron: Ductile & Gray Nonferrous Alloys		32A80-JVBE	38A80-JVBE		32A80-IVBE	38A80-IVBE		32A80-HVBE	38A80-HVBE
		32A80-KVBE	38A80-KVBE		32A80-JVBE	38A80-JVBE		32A80-IVBE	38A80-IVBE
		32A80-KVBE	38A80-KVBE		32A80-JVBE	38A80-JVBE		32A80-IVBE	38A80-IVBE
		39C80-JVK				39C80-IVK			39C80-HVK

TECHtip

SELECTONG A WHEEL WITH THE CORRECT BOND TYPE

SINGLE POINT DIAMOND TOOLS

- Use VBE, V, VS, VS3, and VK bonds for general purpose applications or medium contact areas.
- Use VBEP, VSP, VS3P, VCP, and VP2 bonds on wide contact areas where heat is an issue.



It is the user's responsibility to refer to and comply with ANSI B7.1

VITRIFIED WHEEL BONDS

BOND	DESCRIPTION
VS	Quantum (green) and Norton SG (blue): High stock removal; narrow/medium contact area; roughing/finishing; less burn; cool cutting.
VSP	Quantum (green) and Norton SG (blue): Porous bond; high stock removal; medium/wide contact area; cool cutting; less burn than VS; high chip clearance.
VBE	32A (purple), 38A (white) and 57A (brown): General purpose; narrow/medium contact area; versatile; economical.
VBEP	32A (purple) and 38A (white): Porous bond; medium/wide contact area; cool cutting; less burn than VBE; high chip clearance; high stock removal.
V	38A (orange): For fine grit, form/corner holding applications; narrow contact area.
VK	37C (black) and 39C (green): Designed specifically for silicon carbide abrasives; medium to narrow area of contact.
VCP	32A (purple) and 23A (blue/grey): Induced-pore, wide contact area, surface/creepfeed grinding applications.
VP2	3SGR (ruby), 48A (ruby), 25A (pink) and 38A (white): Unique, controlled-porosity (NORPOR) bond for heat-sensitive applications.
NEW! VS3	Quantum (white) and Norton SG (white): Patented technology produces a strong, exceptionally cool-cutting bond with unprecedented form holding; versatile, for all areas of contact

APPLICATION/GRIT RECOMMENDATION GUIDE

GRIT	REQUIREMENT	FINISH	MINIMUM CORNER RADIUS
46	General Purpose	32 Ra and rougher	0.020"
60	Commercial Finish	32 Ra and better	0.016"
80 – 100	Fine Finish	20 Ra and better	0.0105"
120	Very Fine Finish	10 Ra and better	0.006"
150	Corner-Form Holding		0.005"
180	Corner-Form Holding		0.0035"
220	Corner-Form Holding		0.0026"

CROSS REFERENCE GUIDE

NORTON	CAMEL	CINCINNATI	RADIAC	TYROLIT	WINTERTHUR
Quantum 5NQ		5M5B			
3SGR	AS3	3BP	7BP, 8BP		
5SG	SZA	5MSB	7BW, 8BW		
25A	PA	12A	RAA	88A	57A
32A	AZ	4A, 12A, 29A, 32A	32A, WRA	90A	67A, 68A
38A	83A, WA, AZ (Blue)	9A, 10A, 11A, 82A	WA, 9A	88A, 89A	53A, 49A, 42A
48A			RA	91A	68A
53A	91A, DA	29A, 97A	43A, 45A, 97A, WPA	50A	61A, 64A
57A	94A, CGW, A	A, AK	A	A, 52A	A
37C		6C	C	1C	C
39C		5C	GC	C	11C

STARTING RECOMMENDATIONS FOR TRUING AND DRESSING NORTON TOOLROOM WHEELS

TRUING & DRESSING: DRESSING STICK STARTING RECOMMENDATIONS

SIZE/SPEC.	HIGH PERFORMANCE STICK PART #	SIZE/SPEC.	CONVENTIONAL STICK PART #
3 x 1/2 x 1/4" Norbide	61463610148	6 x 1 x 1" 37C24-SVK	61463610462
		8 x 1 x 1" 37C24-SVK	61463610471
		Other sizes are available. See the Dressing Stick section.	

DRESSING: SINGLE POINT DRESSING TOOL STARTING RECOMMENDATIONS

WHEEL SIZES	TOOL SHANK DIAMETER	CERAMIC (NQ, NORTON SG, TG, ETC.), 37C & 39C WHEELS		25A, 32A, 38A, 48A, 53A, 57A, 64A, 86A WHEELS	
		PRODUCT NO.	PART #	PRODUCT NO.	PART #
Up to 7"	3/8	BCSG2M6	66260157007	BC2M6	66260195000
	7/16	BCSG2M7	66260156905	BC2M7	66260195001
8" to 10"	3/8	BCSG3M6	66260157008	BC3M6	66260195002
	7/16	BCSG3M7	66260156906	BC3M7	66260195003
12" to 14"	3/8	BCSG5M6	66260157009	BC5M6	66260195004
	7/16	BCSG5M7	66260156907	BC5M7	66260195005

THESE TOOLS ARE A STANDARD RECOMMENDATION; SEE THE "DIAMOND TOOL" SECTION FOR ADDITIONAL TOOLS

SEE THE FLIESEN TOOL SECTION FOR FURIOSO TOOLS, ENGINEERED SPECIFICALLY FOR QUANTUM VITRIFIED WHEEL DRESSING

TECHtip

WHEEL DRESSING

SINGLE POINT DIAMOND TOOLS

- Rigidly mount Single Point tools at a 10°-15° angle to the wheel centerline with a line drawn through the center of the wheel, pointing in the direction of wheel travel
- Point of contact should be slightly below centerline of wheel
- Use coolant whenever possible
- Normal infeed is .001" per pass
- Lead selections range from .002" - .010" per wheel revolution
- Rotate the tool 1/4 turn periodically to maintain a sharp point
- Use VBE, V, VS, VK bonds for general purpose applications or medium contact areas.
- Use VBEP, VSP, VS3P, VCP, VP2 bonds on wide contact areas where heat is an issue.



It is the user's responsibility to refer to and comply with ANSI B7.1

MULTI-POINT DIAMOND TOOLS

- Most multi-point tools are used for straight face dressing
- Tool should have full face contact with the wheel
- With new tool, 3 to 5 passes at .005" per pass should be taken to expose diamonds
- Infeed per pass .001" - .002"
- Use coolant whenever possible
- Use appropriate lead (and traverse rate)

Contact your Norton representative for proper tool selection for Targa (TG) wheels

DRESSING CERAMIC WHEELS

- Use our specially designed Norton SG diamond tools when dressing ceramic wheels
- When first using a Norton SG tool, make 3 to 5 passes at .005" infeed to ensure full face contact between the dressing tool and wheel face
- Reduce normal dressing infeed by half. Do not exceed infeed of .002" per pass.
- The lead selection should be between .006" - .030" per wheel revolution. Faster traverse with Norton SG tools generally provides an open wheel face that can maximize productivity of the ceramic abrasive.
- To optimize applications using ceramic abrasives and/or tools, normal dressing parameters must change. Reduce infeed by 25%. Significant reductions in the amount of infeed and frequency of dress will result in substantially lower cost per part ground.

See the Fliesen Tool section for Furioso tools, engineered specifically for Quantum vitrified wheel dressing.



Reshaping the World of Precision Grinding – NEW! Norton Vitrium 3 VS3 Bond

A Revolutionary Bond That Lowers Process Cost In Three Ways

Our exclusive bond platform provides unprecedented wheel performance and finished part accuracy across many precision grinding applications.

- | | |
|---|---|
| 1. Coolest cutting with maximum chip clearance | <ul style="list-style-type: none"> ■ Significantly reduces burn ■ Increases cutting efficiency and cut rate ■ Improves coolant flow ■ Reduces wheel loading ■ Delivers exceptional part quality |
| 2. Optimized precision profile | <ul style="list-style-type: none"> ■ Ultra radius accuracy ■ Extended wheel life; highest productivity ■ Reduced dressing frequency and cost ■ Improved cycle and process time |
| 3. Able to run at higher operating speeds | <ul style="list-style-type: none"> ■ Increases throughput and productivity ■ Leverages existing equipment ■ Maximizes your machine efficiency ■ Best choice for machinery designed and rated for high speed |

Available in non-stock wheels made-to-order to your exact requirements, and in a limited offering of our best-selling stock wheels.

TROUBLESHOOTING GUIDE

Check the obvious first. Before changing the grinding wheel specification, investigate the following most common causes for most grinding problems:

1. Diamond dressing tool condition (check if worn or dull, rotate tool or replace if necessary)
2. Coolant direction, volume and filtration
3. Wheel dressing procedures (dress more open to free up cut rate, dress more closed to improve finish)

PROBLEM	POSSIBLE CAUSE	CORRECTION
Workpiece burn	Poor coolant direction Restricted or low coolant volume Wheel too hard Wheel structure too closed Wheel dressed too fine Worn dressing tool Work speed too slow Infeed too fast	Redirect coolant into grinding zone Increase coolant volume Use one grade softer wheel Use porous bond wheel Dress wheel coarser, more "open" Inspect, rotate or replace dressing tool Increase work speed Reduce stock removed per pass or upgrade to 5SG or 5NQ
Wheel loading and glazing	Wheel too fine Wheel too hard Too durable abrasive Poor coolant quality Wheel structure too closed Wheel too finely dressed Diamond dressing tool worn Depth of cut too small	Use coarser grit or softer grade wheel Use one grade softer wheel Use a sharper, more friable abrasive Change coolant or use high detergent type Use a porous bond wheel Dress wheel very open Replace diamond and dress coarse (open) Increase feed and traverse speed
Chatter	Unsupported work Machine vibration Too heavy cut rate Wheel too hard Wheel structure too closed Wheel out of balance	Increase work support Check for worn bearings Reduce cut rate Use one grade softer wheel Use a porous bond wheel Check wheel balance or try new wheel
Chatter marks on workpiece	Worn spindle bearings Wheel out of truth Poorly clamped wheel Glazed face of wheel	Check and correct for truth and end play Redress wheel and check mounting Check tightness of mounting nuts Redress wheel with sharp dressing tool
Poor surface finish	Incorrect wheel dress Worn dressing tool Too coarse grit size Wheel too hard	Dress wheel finer (slow down dressing tool traverse) Inspect, rotate, or replace dressing tool Use a finer grit size Use softer grade
Not holding form	Wheel too soft Wheel structure too open	Use one grade harder wheel Use a more closed wheel structure
Not holding corner	Incorrect wheel dress Too large grit size Wheel too soft Wheel structure too open	Dress wheel finer. Face and side true wheel. Use smaller grit size (maximum grit diameter less than 1.5 times corner radius) Use harder grade wheel Use more closed structure wheel



Single-Pack Toolroom Wheels

The Small Quantity Order Solution

Available in our most popular specification of BEST, BETTER and GOOD performance tiers. Norton single-pack toolroom wheels provide many opportunities:

- Test order small quantities of a variety of wheel specifications
- Display and safely store your most often used wheels
- No need to repackage small orders from bulk shipments
- Ensure your wheel arrives onsite undamaged

FEATURED PRODUCTS

UPGRADED
PERFORMANCE**NORTON QUANTUM (5NQ)**

BEST CHOICE FOR VERSATILITY, MAXIMUM PERFORMANCE AND COST SAVINGS

FEATURES

- Revolutionary, engineered ceramic grain shape and chemistry with proven bond technology – green
- NEW! Coolest cutting, high-speed, precise form holding Vitrium 3 VS3 Bond

BENEFITS

- Versatile; for all low, medium and high force applications ranging from cast iron, to stainless steel and hard-to-grind Inconel and titanium
- Perform well on old and new machines
- 33% to 100% longer life vs. competitive ceramic products
- 30%+ higher metal removal rate
- 15%+ lower threshold power
- Lowest total grinding costs
- Highest productivity; lowest cycle and process time; most accurate finished parts

UPGRADED
PERFORMANCE**NORTON SG**

BEST CHOICE FOR HIGH PRODUCTIVITY, LOW TOTAL PER-PART GRINDING COST

FEATURES

- High-performance seeded gel ceramic aluminum oxide abrasive
- Self-sharpening abrasive
- High performance VS and VSP bonds
- NEW! coolest cutting, high-speed, precise form holding Vitrium 3 VS3 Bond
- Provide sharp edge on tools and dies
- 5SG – durable Norton SG and aluminum oxide blend – blue
- NORPOR 3SGR – Norton SG and 48A abrasive blend with VP2 porous bond – purple

BENEFITS

- Fast stock removal, cool, superior cutting
- 3X - 5X more life than aluminum oxide wheels
- Double rough stock removal rate versus conventional abrasives
- Less burn, less dressing; very consistent performing wheel
- Versatile; exceptional form holding
- Highest productivity; lowest cycle and process time; most accurate finished parts
- Longer life of tools and dies in production
- High stock removal rates, excellent productivity, long wheel life, low overall grinding cost
- Maximum productivity in heat-sensitive, heavy stock removal operations

**NORTON 32A**

BETTER CHOICE FOR MEDIUM TO HEAVY STOCK REMOVAL

FEATURES

- Sharp monocrystalline aluminum oxide grain – the industry's most versatile abrasive – purple

BENEFITS

- Free cutting on a wide range of applications and materials
- Outstanding form holding

**NORTON 38A**

GOOD CHOICE FOR LIGHT GRINDING OF TOOL STEELS

FEATURES

- White, friable abrasive grain
- Consistent quality
- NORPOR 38A – most friable, aluminum oxide abrasive with VP2 porous bond – white
- Versatile

BENEFITS

- Cool and burn-free cutting; ideal for heat-sensitive applications with light to moderate feed rates
- Excellent balance and dimensional accuracy time after time
- Exceptionally cool cutting in light pressure grinding applications, or heat-sensitive applications
- Ideal for use across a broad variety of tool steels

**NORTON GEMINI ALUMINUM OXIDE**

GOOD CHOICE FOR USE ON GENERAL PURPOSE APPLICATIONS; ECONOMICAL

FEATURES

- Durable aluminum oxide abrasive and strong vitrified bond – Blue
- Versatile, economical

BENEFITS

- Consistent stock removing performance on narrow to medium contact areas; cool cutting
- Ideal when numerous small jobs are run on one machine
- The choice when initial price is the main purchasing criterion

ID and Race Wheels



ID and Race Wheel FastTrack Availability

Type 01 Straight

Diameter: 0.164" thru 4.532"

Thickness: 0.150" thru 2.750"

Type 05 Recessed One Side

Diameter: 0.407" thru 4.625"

Thickness: 3/16" thru 3.100"

ABRASIVE	25A, 32A, 38A, 48A, 53A, 57A	5TG**	Quantum (NQ) 1SG, 3SG, 5SG	32AA
GRIT	46* - 120	80/1, 120/1	36 - 150	46 - 80
GRADE	J - P	I - M	I - N	I - M
STRUCTURE	6	8	6	6
BOND	VFL	VFL	VFL	VFL
SPEED	8,500 SFPM***			
TREAT 22	Available for Quantum (NQ) 32A, and 53A			

* 46 GRIT ONLY AVAILABLE IN .312 DIAMETER

** 5TG IS AVAILABLE IN /1 COMBINATION, ONLY

*** SPEEDS UP TO 12,500 SFPM BY REQUEST AND SAFETY APPROVAL

For more program details, ask your Norton sales representative to review the First Line VFL ID & Race Wheel Brochure #6981 with you.

Vitrified First Line (VFL) ID and Race Wheel availability encompasses over 1,000 wheel sizes and most abrasive types. These high-performance wheels are made-to-order and shipped within two weeks of receipt of your order.

Additional dimensions and grinding faces are available as made-to-order products with 4-week lead-times.

Vitrified Wheels For Steel Applications

AVAILABILITY

TIER:
BRAND:
TRADENAME:
ABRASIVE:



BEST
Norton
NORTON SG
Ceramic Alumina



BETTER
Norton
32A
Aluminum Oxide



GOOD
Norton
38A
Aluminum Oxide

SIZE (D x T x H)	MAX. RPM	MIN./STD. PKG.	SPEC.	PART #	SPEC.	PART #	MIN./STD. PKG.	SPEC.	PART #
Type 01 Straight 									
2 x 1/2 x 3/8	16,235	10/50			32A60-KVBE	66243428214			
3 x 1/4 x 1/2	10,825	10/50			32A60-KVBE	66243528696			
3 x 1/2 x 3/8	10,825	10/50			32A60-KVBE	66243528825	10/50	38A60-JVBE	66243529032
3 x 1/2 x 1/2	10,825	10/50			32A60-KVBE	66243528828			
3 x 1 x 1/2	10,825						1/10	38A60-MVBE	66243529145
	10,825						1/10	38A80-MVBE	66243529146
4 x 1/4 x 1/2	8,120	1/10			32A60-KVBE	66243529532	1/10	38A60-KVBE	66243529777
	8,120						1/10	38A100-IVBE	66243529782
4 x 1/4 x 3/4	8,120	1/10			32A60-KVBE	66243529736			
4 x 1/2 x 1/2	8,120	1/10			32A46-KVBE	66243529845	1/10	38A60-KVBE	66243529947
	8,120						1/10	38A100-KVBE	66243529954
4 x 1/2 x 3/4	8,120	1/10			32A60-KVBE	66243529849	1/10	38A60-KVBE	66243529961
	8,120	1/10			32A80-KVBE	66243529850			
4 x 1 x 1/2	8,120						1/10	38A60-MVBE	66243530126
5 x 1/4 x 1/2	4,970	1/10			32A60-KVBE	66252830572			
6 x 1/8 x 1-1/4	4,140	1/10			32A80-KVBE	66252835361	1/10	38A150-LVBE	66252835506
6 x 1/4 x 1/2	4,140	1/10			32A60-KVBE	66252835784			
6 x 1/4 x 1-1/4	4,140	1/10			32A60-KVBE	66252835786	1/10	38A60-KVBE	66252835803
	4,140						1/10	38A80-KVBE	66252835807
	4,140						1/10	38A150-KV	66252835759
6 x 1/2 x 1/2	4,140	1/10			32A60-KVBE	66252836394	1/10	38A60-KVBE	66252836530
	4,140						1/10	38A80-KVBE	66252836548
6 x 1/2 x 1-1/4	4,140	1/10			32A46-KVBE	66252836380	1/10	38A46-KVBE	66252836520
	4,140	1/10	5SG60-KVS	66252803344	32A60-KVBE	66252836396 B	1/10	38A60-KVBE	66252836533
	4,140	1/10			32A80-JVBE	66252836405	1/10	38A80-KVBE	66252836550
	4,140						1/10	38A120-KVBE	66252836664
6 x 3/4 x 1/2	4,140	1/10			32A60-KVBE	66252837420			
6 x 3/4 x 5/8	4,140						1/10	38A60-KVBE	66252837444
6 x 3/4 x 1-1/4	4,140	1/10			32A60-KVBE	66252837421	1/10	38A60-KVBE	66252837445
6 x 1 x 1-1/4	4,140	1/10			32A60-KVBE	66252837921 B			

B = BEST SELLER; PERFORMS WELL IN A VARIETY OF APPLICATIONS FOR MANY SATISFIED CUSTOMERS S = SINGLE PACK

Vitrified Wheels For Steel Applications

AVAILABILITY



TIER:
BRAND:
TRADENAME:
ABRASIVE:

BEST	BETTER	GOOD
Norton	Norton	Norton
QUANTUM / NORTON SG	32A	38A / GEMINI
Ceramic Alumina	Aluminum Oxide	Aluminum Oxide

SIZE (D x T x H)	MAX. RPM	MIN./STD. PKG.	SPEC.	PART #	SPEC.	PART #	MIN./STD. PKG.	SPEC.	PART #
Type O1 Straight									
7 x 1/8 x 1-1/4	3,275	1/10			32A60-IVBE	66252939112	1/10	38A80-IVBE	66252939219
	3,600						1/10	38A100-KVBE	66252939223
7 x 1/4 x 1-1/4	3,600	1/10	5NQ46-IVS	66253350690	32A46-HVBE	66252939543	1/10	38A46-HVBE	66252939690
	3,600	1/10	5NQ60-JVS	66253293579	32A46-IVBE	66252939544	1/10	38A46-IVBE	66252939691
	3,600	1/10	5SG46-IVS	66252940207 B	32A46-JVBE	66252939545	1/10	38A46-JVBE	66252909755
	3,600	1/10	5SG46-IVS	66253288575 S	32A46-KVBE	66252939862	1/10	38A60-HVBE	66252939695
	3,600	1/10	5SG60-IVS	66252939459 B	32A60-HVBE	66252939547	1/10	38A60-IVBE	66252939696
	3,600	1/10	5SG60-IVS	66253288576 S	32A60-IVBE	66252939548 B	1/10	38A60-JVBE	66252939698
	3,600	1/10	5SG60-JVS	66252939460	32A60-IVBE	66253288569 S	1/10	38A60-KVBE	66252939700
	3,600	1/10	5SG60-KVS	66252939461 B	32A60-JVBE	66252939549 B	1/10	38A80-HVBE	66252939707
	3,600	1/10	5SG60-KVS	66253288577 S	32A60-KVBE	66252939552 B	1/10	38A80-IVBE	66252939808
	3,600	1/10	5SG80-IVS	66252939462	32A60-KVBE	66253288570 S	1/10	38A80-JVBE	66252939809
	3,600	1/10	5SG80-JVS	66252939463	32A80-HVBE	66252939557	1/10	38A80-KVBE	66252939812
	3,600	1/10	5SG80-KVS	66252939464	32A80-IVBE	66252939658 B	1/10	38A100-IVBE	66252939823
	3,600	1/10	5SG100-JVS	66252939467	32A80-IVBE	66253288571 S	1	38A100-IVBE	66252939824 S
	3,600	1/10	5SG100-KVS	66252939468 B	32A80-JVBE	66252939660 B	1/10	38A100-JVBE	66252939826
	3,600	1/10	5SG100-KVS	66253288578 S	32A80-KVBE	66252939662 B	1/10	38A100-KVBE	66252939827
	3,600	1/10			32A80-KVBE	66253288572 S	1/10	38A100-LVBE	66252939830
	3,600	1/10			32A100-IVBE	66252939670 B	1/10	38A120-JVBE	66252939833
	3,600	1/10			32A100-JVBE	66252939672	1/10	38A120-KVBE	66252939834
	3,600	1/10			32A100-IVBE	66253288573 S	1/10	38A150-KVBE	66252939838
	3,600	1/10			32A100-KVBE	66252939673 B	1/10	38A150-LVBE	66252939839
	3,600	1/10			32A100-KVBE	66253288574 S	1/10	38A150-MV	66252939521
	3,600	1/10			32A120-IVBE	66252939680	1/10	38A220-KV	66252939528
	3,600	1/10			32A120-KVBE	66252939682	1/10	38A220-LV	66252939529
	3,600	1/10			32A220-LVBE	66252939689	1/10	38A220-LVBE	66252939847
	3,600	1/10					1/10	38A220-MV	66252939530
	3,600	10/10					10/10	Gemini 60-I	66253246722
	3,600	10/10					10/10	Gemini 60-J	66253246788
	3,600	10/10					10/10	Gemini 60-K	66253246789
3,600	10/10					10/10	Gemini 80-K	66253246792	
7 x 3/8 x 1-1/4	3,600	1/10			32A60-KVBE	66252940276	1/10	38A60-KVBE	66252940294
	3,600	1/10			32A80-KVBE	66252940284	1/10	38A80-IVBE	66252940297
7 x 1/2 x 1-1/4	3,600	1/10	5NQ46-HVS3	66253375053	32A46-FVBEP	66252941203	1/10	25A46-HVP2	66252916219
	3,600	1/10	5NQ46-IVS	69083159103	32A46-GVBE	66252940862	1/10	25A60-HVP2	66252916221
	3,600	1/10	5NQ46-IVS3	66253375052	32A46-GVBEP	66252941204 B	1/10	38A46-GVBE	66252941022
	3,600	1/10	5NQ46-JVS	69083159104	32A46-HVBE	66252940863 B	1/10	38A46-GVBEP	66252941323
	3,600	1/10	5NQ60-GVSP	69083159105	32A46-HVBE	66253288775 S	1/10	38A46-HVBE	66252941023
	3,600	1/10	5NQ60-IVS3	66253375047	32A46-HVBEP	66252941205 B	1	38A46-HVBE	66253288770 S
	3,600	1/10	5NQ60-JVS	69083159106	32A46-IVBE	66252940864 B	1/10	38A46-HVBEP	66252941324
	3,600	1/10	5NQ60-JVS3	66253375046	32A46-IVBE	66253288776 S	1/10	38A46-HVP2	66252916223
	3,600	1/10	3SGP46-GVSP	66252911717	32A46-IVBEP	66252941206	1/10	38A46-IVBE	66252941024
	3,600	1/10	3SGR46-HVP2	66252916211	32A46-JVBE	66252940865 B	1/10	38A46-JVBE	66252941026
	3,600	1/10	3SGR60-HVP2	66252916213	32A46-JVBE	66253288777 S	1	38A46-JVBE	66253288767 S
	3,600	1/10	5SG46-GVSP	66252940522	32A46-KVBE	66252940867 B	1/10	38A46-KVBE	66252941028
	3,600	1/10	5SG46-HVS3	66253375050	32A54-IVBE	66252940873	1/10	38A60-HVBE	66252941035
	3,600	1/10	5SG46-HVSP	66252941130	32A60-GVBEP	66252941313	1/10	38A60-HVBEP	66252941330
	3,600	1/10	5SG46-IVS	66252940193 B	32A60-HVBE	66252940879 B	1/10	38A60-IVBE	66252941036
	3,600	1/10	5SG46-IVS	66253288788 S	32A60-HVBEP	66252941314	1/10	38A60-JVBE	66252941038
	3,600	1/10	5SG46-IVS3	66253375049	32A60-IVBE	66252940880 B	1	38A60-JVBE	66253288766 S
	3,600	1/10	5SG46-IVSP	66252940523	32A60-IVBE	66253288779 S	1/10	38A60-KVBE	66252941041
	3,600	1/10	5SG46-JVS	66252940194 B	32A60-JVBE	66252940882 B	1	38A60-KVBE	66253288769 S
	3,600	1/10	5SG46-JVS	66253288789 S	32A60-JVBEP	66252941316	1/10	38A60-LVBE	66252911677
	3,600	1/10	5SG46-KVS	66252940195	32A60-KVBE	66252940885 B	1/10	38A80-HVBE	66252941047
	3,600	1/10	5SG60-GVSP	66252940524	32A60-KVBE	66253288782 S	1/10	38A80-IVBE	66252941048
	3,600	1/10	5SG60-IVS	66252940196 B	32A60-LVBE	66252940888	1/10	38A80-JVBE	66252941049
	3,600	1/10	5SG60-IVS	66253288791 S	32A80-HVBE	66252940894	1/10	38A80-KVBE	66252941054
	3,600	1/10	5SG60-IVS3	66253375045	32A80-IVBE	66252940895 B	1	38A80-KVBE	66253350641 S
	3,600	1/10	5SG60-IVSP	66252940525	32A80-IVBE	66253288783 S	1/10	38A80-LVBE	66252941056
	3,600	1/10	5SG60-JVS	66252940197 B	32A80-JVBE	66252940897 B	1/10	38A100-IVBE	66252941163
	3,600	1/10	5SG60-JVS	66253288792 S	32A80-KVBE	66252940899 B	1/10	38A100-JVBE	66252941165

B = BEST SELLER; PERFORMS WELL IN A VARIETY OF APPLICATIONS FOR MANY SATISFIED CUSTOMERS S = SINGLE PACK

CONTINUED

Vitrified Wheels For Steel Applications CONTINUED

AVAILABILITY

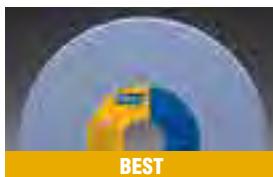

TIER:
BRAND:
TRADENAME:
ABRASIVE:

BEST	BETTER
Norton	Norton
QUANTUM / NORTON SG	32A / 48A
Ceramic Alumina	Aluminum Oxide

GOOD
Norton
38A / GEMINI
Aluminum Oxide

SIZE (D x T x H)	MAX. RPM	MIN./STD. PKG.	SPEC.	PART #	SPEC.	PART #	MIN./STD. PKG.	SPEC.	PART #
Type O1 Straight <input type="checkbox"/> <input type="checkbox"/> <input type="checkbox"/>									
7 x 1/2 x 1-1/4	3,600	1/10	5SG60-JVS3	66253375043	32A80-KVBE	66253288784 S	1/10	38A100-KVBE	66252941168
	3,600	1/10	5SG60-KVS	66252940198	32A80-LVBE	66252940900	1/10	38A120-JVBE	66252941174
	3,600	1/10	5SG60-LVS	66252940199	32A100-IVBE	66252940907	1/10	38A120-KVBE	66252941175
	3,600	1/10	5SG80-IVS	66252940200	32A100-JVBE	66252941008	1/10	38A150-JVBE	66252941179
	3,600	1/10	5SG80-IVSP	66252940527	32A120-LVBE	66252941018 B	1/10	38A150-MV	66252940595
	3,600	1/10	5SG80-JVS	66252940201 B	32A120-LVBE	66253288786 S	1/10	38A220-QV	66252940605
	3,600	1/10	5SG80-JVS	66253288793 S	48A46-HVP2	66252916215 B	10/10	Gemini 46-H	66253246795
	3,600	1/10	5SG80-KVS	66252940202	48A60-HVP2	66252916217 B	10/10	Gemini 46-I	66253246800
	3,600	1/10	5SG80-LVS	66252940203			10/10	Gemini 46-J	66253246802
	3,600	1/10	5SG100-JVS	66252940204			10/10	Gemini 46-K	66253246812
	3,600	1/10	5SG100-KVS	66252940205			10/10	Gemini 60-I	66253246818
	3,600						10/10	Gemini 60-J	66253246820
	3,600						10/10	Gemini 60-K	66253246821
	3,600						10/10	Gemini 80-K	66253246832
	3,600						10/10	Gemini 100-K	66253246838
7 x 5/8 x 1-1/4	3,600	1/10			32A60-IVBE	66252941762			
7 x 3/4 x 1-1/4	3,600	1/10	5SG46-IVS	66252942304	32A46-GVBEP	66252942070	1/10	38A46-HVBE	66252941950
	3,600	1/10	5SG46-KVS	66252942305	32A46-HVBE	66252941930	1/10	38A46-KVBE	66252941954
	3,600	1/10	5SG60-JVS	66252942307	32A46-IVBE	66252941931	1/10	38A60-IVBE	66252942207
	3,600	1/10	5SG60-KVS	66252942308	32A46-KVBE	66252941935	1/10	38A60-KVBE	66252942060
	3,600	1/10			32A60-IVBE	66252941938			
	3,600	1/10			32A60-KVBE	66252941943			
7 x 1 x 1-1/4	3,600	1/10	5SG60-JVS	66252942429	32A80-IVBE	66252941946			
	3,600	1/10	5SG60-KVS	66252942430	32A46-HVBE	66252942513	1/10	38A46-HVBE	66252942534
	3,600	1/10			32A46-JVBE	66252942268			
200mm x 10mm x 31.75mm	2,870	5	320 S/C Organic Micro Dressing wheels	66253296349*	32A60-IVBE	66252942524			
					32A60-KVBE	66252942709			
8 x 1/4 x 1-1/4	+	1/10	5SG60-KVS	66253043351	32A46-HVBE	66253043412	1/10	38A60-IVBE	66253043431
	+	1/10	5SG80-KVS	66253043353	32A46-IVBE	66253043310	1/10	38A60-JVBE	66253043432
	3,600	1/10			32A46-KVBE	66253043413	1/10	38A60-KVBE	66253010825
	3,600	1/10			32A60-IVBE	66253043416 B	1/10	38A80-IVBE	66253043437
	3,600	1/10			32A60-IVBE	66253288796 S	1/10	38A80-JVBE	66253043439
	3,600	1/10			32A60-JVBE	66253043417	1/10	38A80-KVBE	66253043461
	3,600	1/10			32A60-KVBE	66253043399	1/10	38A100-IVBE	66253043445
	3,600	1/10			32A80-IVBE	66253043421	1/10	38A100-KVBE	66253043447
	3,600	1/10			32A80-KVBE	66253043458 B	1/10	38A120-KVBE	66253043450
	3,600	1/10			32A80-KVBE	66253288797 S	1/10	38A150-KVBE	66253043451
	3,600	1/10			32A80-LVBE	66253043425			
	3,600	1/10			32A100-IVBE	66253043426			
	3,600	1/10			32A100-KVBE	66253043428			
	3,600	1/10			32A60-KVBE	66253043565			

B = BEST SELLER; PERFORMS WELL IN A VARIETY OF APPLICATIONS FOR MANY SATISFIED CUSTOMERS S = SINGLE PACK
* = FOR FINE GRIT DIAMOND POLYIMIDE WHEELS

TECHtip

8" TYPE O1 AND TYPE O5 VITRIFIED TOOLROOM WHEELS' MAXIMUM OPERATING SPEEDS:

- Stock NorPor VP2 wheels = 3,600 RPMs
- All other 46 grit, J grade and harder = 3,600 RPMs
- All other 54 grit, I grade and harder = 3,600 RPMs
- All other 60 grit and finer, H grade and harder = 3,600 RPMs

- † Exceptions to the rule: speed-tested to 3,600 RPM
- All other specifications = 3,105 RPMs



It is the user's responsibility to refer to and comply with ANSI B7.1

For non-stock toolroom wheels: if you don't see the toolroom wheel you need in our stock listing, call your local authorized Norton distributor to check our made-to-order non-stock availability – including our revolutionary new Quantum and Vitrium[®] bond ceramic wheels.
PanAmericanDistribution.com Email: panamericandistribution@gmail.com

Vitrified Wheels For Steel Applications CONTINUED

AVAILABILITY

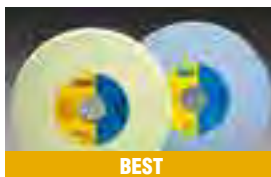

TIER:
BRAND:
TRADENAME:
ABRASIVE:

BEST
Norton
QUANTUM / NORTON SG
Ceramic Alumina

BETTER
Norton
32A / 48A
Aluminum Oxide

GOOD
Norton
38A / 25A / GEMINI / 57A
Aluminum Oxide

SIZE (D x T x H)	MAX. RPM	MIN./STD. PKG.	SPEC.	PART #	SPEC.	PART #	MIN./STD. PKG.	SPEC.	PART #
Type O1 Straight									
8 x 1/2 x 1-1/4	+	1/10	5NQ46-HVS3	66253387211	32A46-GVBEP	66253043882 B	1/10	25A46-HVP2	66253019354
	3,105	1/10	5NQ46-IVS	69083159107	32A46-HVBE	66253043712 B	1/10	38A46-HVBE	66253043746
	3,105	1/10	5NQ46-IVS3	66253387212	32A46-HVBE	66253288800 S	1	38A46-HVBE	66253350640 S
	+	1/10	5NQ46-JVS	69083159108	32A46-HVBEP	66253043883 B	1/10	38A46-HVBEP	66253043891 †
	3,105	1/10	5NQ60-GVSP	69083159109	32A46-IVBE	66253043713 B	1/10	38A46-IVBE	66253043749
	3,600	1/10	5NQ60-IVS3	66253387214	32A46-JVBE	66253043715 B	1/10	38A46-JVBE	66253043752
	3,600	1/10	5NQ60-JVS	69083159110	32A46-JVBE	66253288801 S	1/10	38A46-KVBE	66253043762
	3,600	1/10	5NQ60-JVS3	66253387213	32A46-KVBE	66253043716 B	1/10	38A60-HVBE	66253043756
	+	1/10	3SGP46-HVSP	66253011505	32A60-FVBEP	66253043886 †	1/10	38A60-IVBE	66253043757
	+	1/10	3SGP46-JVH	66253013796	32A60-GVBEP	66253043887 †	1/10	38A60-JVBE	66253043858
	3,600	1/10	3SGR46-GVP2	66253019345	32A60-HVBE	66253043724	1/10	38A60-KVBE	66253043861
	3,600	1/10	3SGR46-HVP2	66253019346	32A60-HVBEP	66253043888	1/10	38A80-IVBE	66253043866
	3,600	1/10	3SGR60-HVP2	66253019348	32A60-IVBE	66253043725 B	1/10	38A80-JVBE	66253013787
	+	1/10	5SG46-GVSP	66253043649	32A60-IVBE	66253288802 S	1/10	38A80-KVBE	66253043869
	+	1/10	5SG46-HVS3	66253387220	32A60-JVBE	66253043727 B	1/10	38A100-KVBE	66253043877
	+	1/10	5SG46-HVSP	66253043915 †	32A60-KVBE	66253043729 B	10/10	Gemini 46-H	66253246841
	+	1/10	5SG46-IVS	66253044089 B	32A60-KVBE	66253288803 S	10/10	Gemini 46-I	66253246843
	+	1/10	5SG46-IVS	66253288804 S	32A80-HVBE	66253043733	10/10	Gemini 46-J	66253246845
	+	1/10	5SG46-IVS3	66253387221	32A80-IVBE	66253043734	10/10	Gemini 46-K	66253246848
	+	1/10	5SG46-IVSP	66253043650	32A80-JVBE	66253043736	10/10	Gemini 60-J	66253246857
	3,600	1/10	5SG46-JVS	66253044090 B	32A80-KVBE	66253043737			
	3,600	1/10	5SG46-JVS	66253288806 S	32A100-IVBE	66253043740			
	3,600	1/10	5SG46-KVS	66253044091	32A100-KVBE	66253043742			
	3,600	1/10	5SG60-GVSP	66253043651 †	48A46-HVP2	66253019350 B			
	3,600	1/10	5SG60-IVS	66253044092					
	3,600	1/10	5SG60-IVS3	66253387225					
	3,600	1/10	5SG60-IVSP	66253043652					
	3,600	1/10	5SG60-JVS	66253044093 B					
	3,600	1	5SG60-JVS	66253288808 S					
	3,600	1/10	5SG60-JVS3	66253387228					
	3,600	1/10	5SG60-KVS	66253044094					
	3,600	1/10	5SG80-JVS	66253044096					
	3,600	1/10	5SG80-KVS	66253044097					
	3,600	1/10	5SG100-KVS	66253019435					
8 x 3/4 x 1-1/4	3,105	1/10	5NQ46-IVS	69083159111	32A46-GVBEP	66253044195	1/10	38A46-HVBE	66253044175
	+	1/10	5NQ46-JVS	69083159112	32A46-HVBE	66253044159	1/10	38A46-IVBE	66253044177
	+	1/10	5NQ60-GVSP	69083159113	32A46-HVBEP	66253044196 †	1/10	38A46-KVBE	66253044180
	+	1/10	5NQ60-JVS	69083159114	32A46-IVBE	66253044215	1/10	38A60-IVBE	66253044184
	+	1/10	5SG46-IVS	66253044098	32A46-JVBE	66253044161			
	3,600	1/10	3SGP46-JVH	66253013792	32A46-KVBE	66253044165			
	+	1/10	5SG46-JVS	66253044099 B	32A60-GVBEP	66253044198			
	3,600	1/10	5SG60-IVS	66253044101	32A60-HVBE	66253044168			
	3,600	1/10	5SG60-JVS	66253044102	32A60-IVBE	66253044169			
	3,600	1/10	5SG60-KVS	66253044103	32A60-JVBE	66253044171			
	3,600	1/10			32A60-KVBE	66253044173			
	3,600	1/10			32A80-KVBE	66253044064			
8 x 1 x 1-1/4	+	1/10	5SG46-KVS	66253002588	32A46-HVBE	66253044616	1/10	38A46-IVBE	66253044636
	+	1/10	5SG60-GVSP	66253003228†	32A46-IVBE	66253044617	1/10	38A60-IVBE	66253044456
	3,600	1/10	5SG60-IVS	66253002639	32A46-KVBE	66253044622	1/10	57A60-MVBE	66253044270
	3,600	1/10			32A60-IVBE	66253044624			
	3,600	1/10			32A60-KVBE	66253044629			
10 x 1/4 x 3	2,485						1/-	38A80-KVBE	66253149572
10 x 1/2 x 3	2,485	1/-			32A60-JVBE	66253149729	1/-	38A60-KVBE	66253149859
	2,485						1/-	38A80-KVBE	66253149865
10 x 3/4 x 3	2,485	1/-			32A46-IVBE	66253160024	1/-	38A46-JVBE	66253160158
	2,485	1/-			32A60-IVBE	66253160137	1/-	38A60-IVBE	66253160163
	2,485	1/-			32A60-KVBE	66253160143			
10 x 1 x 1-1/4	2,485	1/-			32A60-KVBE	66253160774			
10 x 1 x 2	2,485	1/-			32A46-IVBE	66253160749			

+ † REFER TO THE TECH TIPS ON PREVIOUS PAGE. B = BEST SELLER; PERFORMS WELL IN A VARIETY OF APPLICATIONS FOR MANY SATISFIED CUSTOMERS S = SINGLE WHEEL PACK

Vitrified Wheels For Steel Applications CONTINUED

AVAILABILITY

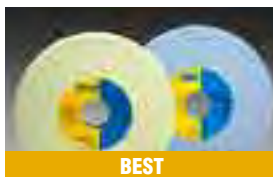

TIER:
BRAND:
TRADENAME:
ABRASIVE:

BEST
Norton
QUANTUM / NORTON SG
Ceramic Alumina

BETTER
Norton
32A / 48A
Aluminum Oxide

GOOD
Norton
38A
Aluminum Oxide

SIZE (D x T x H)	MAX. RPM	MIN./STD. PKG.	SPEC.	PART #	SPEC.	PART #	MIN./STD. PKG.	SPEC.	PART #
Type O1 Straight									
10 x 1 x 3	2,485	1/-	5SG46-GVSP	66253160494	32A46-HVBE	66253160747	1/-	38A46-IVBE	66253160889
	2,485	1/-	5SG46-IVS	66253160400	32A46-IVBE	66253160750	1/-	38A46-JVBE	66253160892
	2,485	1/-	5SG46-JVS	66253160401	32A46-JVBE	66253160754	1/-	38A60-IVBE	66253160898
	2,485	1/-	5SG46-KVS	66253160402	32A46-KVBE	66253160758	1/-	38A60-KVBE	66253160900
	2,485	1/-	5SG60-GVSP	66253160495	32A60-IVBE	66253160769			
	2,485	1/-	5SG60-IVS	66253160403	32A60-KVBE	66253160777			
	2,485	1/-	5SG60-JVS	66253160404	32A80-KVBE	66253160782			
	2,485	1/-	5SG60-KVS	66253160405					
12 x 1/2 x 3	2,070	2/-			32A60-JVBE	66253262134			
	2,070	2/-			32A80-KVBE	66253262110			
12 x 1/2 x 5	2,070	2/-			32A60-KVBE	66253262107			
	2,070	2/-			32A80-KVBE	66253262111			
12 x 3/4 x 3	2,070	1/-	5SG46-IVS	66253262204	32A46-GVBEP	66253262392	1/-	38A46-JVBE	66253262281
	2,070	1/-			32A46-HVBE	66253262260			
	2,070	1/-			32A46-IVBE	66253262261			
	2,070	1/-			32A60-IVBE	66253262270			
	2,070	1/-			32A60-KVBE	66253262273			
12 x 1 x 1-1/4	2,070	1/-			32A46-KVBE	66253262570			
12 x 1 x 3	•	1/-	3SGR46-HVP2	66253220885	32A46-GVBEP	66253262840	1/-	38A46-HVBE	66253262700
	2,070	1/-	5SG46-HVSP	66253262488	32A46-HVBE	66253262562	1/-	38A46-IVBE	66253262702
	2,070	1/-	5SG46-IVS	66253262500	32A46-HVBEP	66253262842	1/-	38A46-JVBE	66253262704
	2,070	1/-	5SG46-JVS	66253262501	32A46-IVBE	66253262564	1/-	38A60-IVBE	66253262713
	2,070	1/-	5SG46-KVS	66253262502	32A46-JVBE	66253262567			
	2,070	1/-	5SG60-GVSP	66253262593	32A46-KVBE	66253262572			
	2,070	1/-	5SG60-IVS	66253262503	32A60-HVBE	66253262580			
	2,070	1/-	5SG60-JVS	66253262504	32A60-IVBE	66253262581			
	2,070	1/-	5SG60-KVS	66253262505	32A60-KVBE	66253262689			
	2,070	1/-			32A80-KVBE	66253262532			
	2,710	1/-			48A60-HVP2	66253220891			
	12 x 1 x 5	2,070	1/-	5SG46-GVSP	66253262594	32A46-GVBEP	66253262841	1/-	38A46-IVBE
2,070		1/-	5SG46-IVS	66253262508	32A46-HVBE	66253262563	1/-	38A60-KVBE	66253262719
2,070		1/-	5SG46-JVS	66253262509 B	32A46-IVBE	66253262565			
2,070		1/-	5SG46-KVS	66253262510	32A46-KVBE	66253262573			
2,070		1/-	5SG60-GVSP	66253262595	32A60-HVBE	66253262734			
2,070		1/-	5SG60-IVS	66253262511	32A60-IVBE	66253262582			
2,070		1/-	5SG60-JVS	66253262512	32A60-JVBE	66253262686			
2,070		1/-	5SG60-KVS	66253262513	32A60-KVBE	66253262691 B			
2,070		1/-	5SG80-JVS	66253262515	32A80-JVBE	66253262696			
2,070		1/-			32A80-KVBE	66253262697			
12 x 1-1/4 x 3	2,070	1/-			32A46-IVBE	66253262301			
12 x 1-1/2 x 1-1/4	2,070	1/-			32A46-KVBE	66253263146			
12 x 1-1/2 x 3	2,070	1/-	5SG46-IVS	66253202820	32A46-HVBE	66253263143			
	2,070	1/-			32A46-IVBE	66253263144			
	2,070	1/-			32A60-JVBE	66253263123			
12 x 1-1/2 x 5	2,070	1/-	5NQ46-IVS	69083159115	32A46-GVBEP	66253263192	1/-	38A46-IVBE	66253214987
	2,070	1/-	5NQ46-JVS	69083159116	32A46-HVBE	66253263128			
	2,070	1/-	5NQ60-GVSP	69083159117	32A46-IVBE	66253263145			
	2,070	1/-	5NQ60-JVS	69083159118	32A46-JVBE	66253263120			
	2,070	1/-	3SGP60-GVSP	66253215030	32A60-HVBE	66253263149			
	2,070	1/-	5SG46-GVSP	66253203453	32A60-KVBE	66253263034			
	2,070	1/-	5SG46-IVS	66253202842					
	2,070	1/-	5SG46-JVS	66253202926					
	2,070	1/-	5SG60-GVSP	66253262596					
12 x 2 x 1-1/4	2,070	1/-			32A46-KVBE	66253263461			
	2,070	1/-			32A46-MVBE	66253263463			
12 x 2 x 3	2,070	1/-			32A46-IVBE	66253263459			
12 x 2 x 5	2,070	1/-			32A46-HVBE	66253263403			
	2,070	1/-			32A46-IVBE	66253262302			
	2,070	1/-			32A60-KVBE	66253263465			

+ † REFER TO THE TECH TIPS AT THE BOTTOM OF PAGE 223 • 12" TYPE O1 WHEEL MAXIMUM RPM: NORPOR WHEELS = 2,710; ALL OTHERS = 2,070

B = BEST SELLER; PERFORMS WELL IN A VARIETY OF APPLICATIONS FOR MANY SATISFIED CUSTOMERS

Vitrified Wheels For Steel Applications CONTINUED

AVAILABILITY



TIER:	BEST	BETTER	GOOD
BRAND:	Norton	Norton	Norton
TRADENAME:	QUANTUM / NORTON SG	32A	38A / 57A
ABRASIVE:	Ceramic Alumina	Aluminum Oxide	Aluminum Oxide

SIZE (D x T x H)	MAX. RPM	MIN./STD. PKG.	SPEC.	PART #	SPEC.	PART #	MIN./STD. PKG.	SPEC.	PART #
Type O1 Straight									
14 x 1/2 x 5	1,800	1/-	5SG80-KVS	66253363814	32A60-KVBE	66253363761			
14 x 3/4 x 5	1,800	1/-			32A60-KVBE	66253363772			
14 x 1 x 3	1,800	1/-	5SG46-IVS	66253363960	32A46-HVBE	66253363912			
	1,800	1/-	5SG46-KVS	66253363961	32A46-IVBE	66253363914			
14 x 1 x 5	1,800	1/-			32A60-IVBE	66253363927			
	1,800	1/-	5SG46-GVSP	66253364108	32A46-GVBEP	66253364074	1/-	38A46-HVBE	66253364043
	1,800	1/-	5SG46-HVSP	66253313990	32A46-HVBE	66253363913	1/-	38A60-IVBE	66253363947
	1,800	1/-	5SG46-IVS	66253363970	32A46-IVBE	66253363915	1/-	38A60-JVBE	66253364051
	1,800	1/-	5SG46-JVS	66253363971	32A46-JVBE	66253363919	1/-	38A60-KVBE	66253364053
	1,800	1/-	5SG60-IVS	66253363974	32A46-KVBE	66253363921	1/-	38A80-KVBE	66253364058
	1,800	1/-	5SG60-IVSP	66253363871	32A60-GVBEP	66253364077	1/-	57A60-KVBE	66253364065
	1,800	1/-	5SG60-JVS	66253363975	32A60-HVBE	66253363926	1/-	57A60-LVBE	66253364066
	1,800	1/-	5SG60-KVS	66253363976	32A60-JVBE	66253363930	1/-	57A80-MVBE	66253364070
	1,800	1/-	5SG80-JVS	66253363979	32A60-KVBE	66253363932			
	1,800	1/-	5SG80-KVS	66253364003	32A60-LVBE	66253364035			
	1,800	1/-			32A80-JVBE	66253364038			
	1,800	1/-			32A80-KVBE	66253364039			
14 x 1 x 8	1,800	1/-			32A60-IVBE	66253363887			
14 x 1-1/2 x 5	1,800	1/-	5NQ46-HVS3	66253387216	32A46-GVBEP	66253364238	1/-	38A46-HVBE	66253313968
	1,800	1/-	5NQ46-IVS3	66253387219	32A46-HVBE	66253364335 B	1/-	38A46-HVBEP	66253313969
	1,800	1/-	5NQ46-IVS	69083159119	32A46-HVBEP	66253364243	1/-	38A46-IVBE	66253364090
	1,800	1/-	5NQ46-JVS	69083159120	32A46-IVBE	66253364336	1/-	38A46-JVBE	66253364240
	1,800	1/-	5NQ60-GVSP	69083159122	32A46-JVBE	66253364337	1/-	38A60-IVBE	66253364247
	1,800	1/-	5NQ60-JVS	69083159124	32A46-KVBE	66253364339			
	1,800	1/-	3SGP46-GVSP	66253306780	32A60-HVBE	66253364340			
	1,800	1/-	3SGP46-HVSP	66253307025	32A60-IVBE	66253364239			
	1,800	1/-	3SGP46-JVH	66253313976	32A60-JVBE	66253364341			
	1,800	1/-	5SG46-GVSP	66253364320	32A60-KVBE	66253364342			
	1,800	1/-	5SG46-HVS3	66253387231	32A80-JVBE	66253364246			
	1,800	1/-	5SG46-HVSP	66253302625					
	1,800	1/-	5SG46-IVS	66253364097					
	1,800	1/-	5SG46-IVS3	66253387234					
	1,800	1/-	5SG46-IVSP	66253302498					
	1,800	1/-	5SG46-JVS	66253364098 B					
	1,800	1/-	5SG60-IVS	66253364100					
	1,800	1/-	5SG60-JVS	66253364101					
	1,800	1/-	5SG60-KVS	66253302160					
	1,800	1/-	5SG80-KVS	66253363815					
14 x 2 x 5	1,800	1/-	5SG60-JVS	66253364414	32A46-IVBE	66253364323			
	1,800	1/-			32A46-JVBE	66253364508			
	1,800	1/-			32A46-KVBE	66253364509			
	1,800	1/-			32A60-KVBE	66253364510			

B = BEST SELLER; PERFORMS WELL IN A VARIETY OF APPLICATIONS FOR MANY SATISFIED CUSTOMERS

DRESSING: SINGLE POINT DRESSING TOOL STARTING RECOMMENDATIONS

WHEEL SIZES	TOOL SHANK DIAMETER	CERAMIC (NQ, NORTON SG, TG, ETC.), 37C & 39C WHEELS		25A, 32A, 38A, 48A, 53A, 57A, 64A, 86A WHEELS	
		PRODUCT NO.	PART #	PRODUCT NO.	PART #
12" to 14"	3/8"	BCSG5M6	66260157009	BC5M6	66260195004
	7/16"	BCSG5M7	66260156907	BC5M7	66260195005

THESE TOOLS ARE A STANDARD RECOMMENDATION; SEE THE "DIAMOND TOOL" SECTION FOR ADDITIONAL TOOLS. SEE THE FLIENEN TOOL SECTION FOR FURIOSO TOOLS, ENGINEERED SPECIFICALLY FOR QUANTUM VITRIFIED WHEEL DRESSING.

Vitrified Wheels For Steel Applications CONTINUED

AVAILABILITY



TIER: **BETTER**
 BRAND: Norton
 TRADENAME: **32A / 23A**
 ABRASIVE: Aluminum Oxide

TIER: **GOOD**
 BRAND: Norton
 TRADENAME: **38A / 53A / 57A**
 ABRASIVE: Aluminum Oxide

SIZE (D x T x H)	MAX. RPM	MIN./STD. PKG.	SPEC.	PART #	MIN./STD. PKG.	SPEC.	PART #
Type O2 Cylinder							
6 x 1 x 4	3,600	1/10	32A46-KVBE	66252838308	1/10	38A80-HVBE	66252838314
Rim 1"	3,600	1/10	32A60-JVBE	66252838309			
Plate A47466							
6 x 3-7/8 x 4.875	3,600				2/-	54-K+	66253049499
Used in Pairs						Knife Sharpening	
Rim 9/16"							
(ME159035)							
Plate A308567							
8 x 2 x 5-1/2	2,865				1/8	53A46-KVBE	66253044942
Rim 1-1/4"							
Plate A50831							
8 x 3-1/2 x 6-1/2	4,060				2/-	57A54-K+8VBE	66253038939
Used in Pairs							
Rim 3/4"							
(ME151086)							
Plate A76209							
10 x 2 x 7-1/2	2,295	1/-	32A54-JVG	66253161687	1/-	53A60-KVG	66253161701
Rim 1-1/4"							
(ME62845)							
Plate A110170							
11 x 5	1,910	1/-	32A30-HVBE	66253161800			
Rim 1" (ME33437)							
Tape Wound							
11 x 5	1,740	1/-	32A36-EVBEP	66253161780	1/-	38A46-GVBE	66253161807
Rim 1" (ME52726)	1,910	1/-	32A36-GVBEP	66253161808			
Tape Wound	1,910	1/-	32A46-HVBE	66253161893			
14 x 4 x 11	1,640				1/-	38A46-KVBE	66253364652
Rim 1-1/2"							
(ME62806)							
Plate A52814							
Tape Wound							
18 x 5 Rim 1-1/2"	1,065	1/-	32A30-E19VCP	66253465142			
(ME15536)							
Tape Wound							
18 x 5 Rim 1-1/2"	1,170	1/-	23A30-F19VCP	66253465235			
(ME52719)							
Tape Wound							
Includes Strips							
Type O5 Recessed One Side							
3/4 x 3/4 x 1/4	43,290	5/40	32A60-KVBE	66243427582			
Recess 1/S 3/8 x 3/8							
1 x 1 x 1/4	32,470	5/40	32A60-KVBE	66243427769			
Recess 1/S 1/2 x 1/2							
1 x 1 x 3/8	32,470	5/40	32A60-KVBE	66243427773			
Recess 1/S 1/2 x 1/2							
1-1/4 x 1 x 3/8	25,975	5/40	32A60-KVBE	66243427799			
Recess 1/S 5/8 x 1/2							
1-1/2 x 1 x 3/8	25,975	5/40	32A60-KVBE	66243427938			
Recess 1/S 5/8 x 1/2							

CONTINUED

For non-stock toolroom wheels: if you don't see the toolroom wheel you need in our stock listing, call your local authorized Norton distributor to check our made-to-order non-stock availability – including our revolutionary new Quantum and Vitrium³ bond ceramic wheels.

Vitrified Wheels For Steel Applications CONTINUED

AVAILABILITY



TIER:
BRAND:
TRADENAME:
ABRASIVE:

BEST	BETTER	GOOD
Norton	Norton	Norton
QUANTUM / NORTON SG	32A / 48A	38A / GEMINI
Ceramic Alumina	Aluminum Oxide	Aluminum Oxide

SIZE (D x T x H)	MAX. RPM	MIN./STD. PKG.	SPEC.	PART #	SPEC.	PART #	MIN./STD. PKG.	SPEC.	PART #
Type 05 Recessed One Side									
1-1/2 x 1 x 3/8	21,645	5/40			32A60-KVBE	66243427937			
Recess 1/S 3/4 x 1/2									
2 x 1 x 3/8	16,235	5/40			32A60-KVBE	66243428329			
Recess 1/S 3/4 x 1/2									
2 x 1-1/2 x 5/8	16,235	10/30			32A60-KVBE	66243428332			
Recess 1/S 1 x 3/4									
7 x 3/4 x 1-1/4	3,600	1/10	5SG46-IVS	66252941976	32A46-HVBE	66252942209	1/10	38A46-IVBE	66252942222
Rec 1/S 2-3/4 x 1/4	3,600	1/10	5SG60-IVS	66252942312	32A46-IVBE	66252942211	1/10	38A60-IVBE	66252942225
	3,600	1/10			32A46-JVBE	66252942213			
	3,600	1/10			32A60-IVBE	66252942217			
	3,600	1/10			32A60-JVBE	66252942218			
	3,600	1/10			32A60-KVBE	66252942205			
7 x 3/4 x 1-1/4	3,600						10/10	Gemini 46-J	66253246826
Rec 1/S 3 x 1/4	3,600						10/10	Gemini 60-J	66253246830
7 x 1 x 1-1/4	3,600	1/10	3SGR46-HVP2	66252916228	32A46-GVBEP	66252942826			
Rec 1/S 2-3/4 x 1/2	3,600	1/10	5SG46-IVS	66252942318	32A46-HVBE	66252942688			
	3,600	1/10	5SG46-JVS	66252942427	32A46-HVBEP	66252942828			
	3,600	1/10	5SG60-JVS	66252942431	32A46-IVBE	66252942691			
	3,600	1/10			32A46-KVBE	66252942708			
	3,600	1/10			32A60-IVBE	66252942699			
	3,600	1/10			32A60-JVBE	66252942701			
	3,600	1/10			32A60-KVBE	66252942703			
	3,600	1/10			48A46-HVP2	66252916232			
7 x 1 x 1-1/4	3,600	1/10	5NQ46-IVS	66253350691	32A46-HVBE	66252942689	1/10	38A46-HVBE	66252942707
Rec 1/S 3 x 1/2	3,600	1/10	5SG46-IVS	66252901814	32A46-IVBE	66252942690	1/10	38A46-IVBE	66252942809
	3,600	1/10	5SG60-IVS	66252906907	32A60-IVBE	66252942686	1/10	38A46-KVBE	66252942793
	3,600	1/10					1/10	38A60-IVBE	66252942815
	3,600	1/10					1/10	38A60-JVBE	66252942816
	3,600	1/10					1/10	38A60-KVBE	66252942817
	3,600	1/10					10/10	Gemini 46-H	66253246831
	3,600	1/10					10/10	Gemini 46-J	66253246835
	3,600	1/10					10/10	Gemini 60-J	66253246839
7 x 1-1/4 x 1-1/4	3,600	1/5			32A46-HVBE	66252942833			
Rec 1/S 2-3/4 x 5/8	3,600	1/5			32A60-IVBE	66252942859			
	3,600	1/5			32A60-JVBE	66252942835			
7 x 1-1/2 x 1-1/4	3,600	1/5			32A46-IVBE	66252942843			
Rec 1/S 2-3/4 x 3/4	3,600	1/5			32A60-IVBE	66252942844			
8 x 3/4 x 1-1/4	3,105	1/10			32A46-IVBE	66253044213			
Rec 1/S 3-1/4 x 1/4									
8 x 1 x 1-1/4	3,105						10/10	Gemini 46-H	66253246849
Rec 1/S 3 x 1/2	3,600						10/10	Gemini 46-J	66253246850
8 x 1 x 1-1/4	3,105	1/10	5SG46-IVS	66253013543	32A46-IVBE	66253044790			
Rec 1/S 3-1/4 x 1/2	3,600	1/10	5SG46-JVS	66253003301	32A46-JVBE	66253044382			
	3,600	1/10			32A60-IVBE	66253044753			
	3,600	1/10			32A60-KVBE	66253044810			
10 x 3/4 x 2	2,485	1/-			32A60-JVBE	66253160189			
Rec Side A									
5 x 3/16 Face Bev									
Side A 75 Deg									
From 1/8" Flat									
12 x 1-1/2 x 3	2,070	1/-			32A46-IVBE	66253263186			
Rec 1/S 6 x 1/2									
12 x 1-1/2 x 5	•	1/-	3SGR46-HVP2	66253220904	32A46-HVBEP	66253263180	1/-	38A46-IVBE	66253263175
Rec 1/S 7-1/2 x 1/2	2,070	1/-	5SG46-GVSP	66253263127	32A46-IVBE	66253263166			
	2,070	1/-	5SG46-IVS	66253202883	32A46-JVBE	66253263169			
	2,070	1/-	5SG60-IVSP	66253263050	32A46-KVBE	66253263170			
	2,070	1/-			32A60-KVBE	66253263172			

• 12" TYPE 05 WHEEL MAXIMUM RPM: NORPOR VP2 WHEELS = 2,710; ALL OTHERS = 2,070

Vitrified Wheels For Steel Applications CONTINUED

AVAILABILITY



TIER:
BRAND:
TRADENAME:
ABRASIVE:

BEST	BETTER	GOOD
Norton	Norton	Norton
NORTON SG	32A / 48A	38A / 25A / 53A
Ceramic Alumina	Aluminum Oxide	Aluminum Oxide

SIZE (D x T x H)	MAX. RPM	MIN./STD. PKG.	SPEC.	PART #	SPEC.	PART #	MIN./STD. PKG.	SPEC.	PART #
Type 05 Recessed One Side									
14 x 1-1/2 x 5	•	1/-	3SGR46-GVP2	66253319953	32A46-HVBE	66253364359			
Rec 1/S 8 x 1/2	•	1/-	3SGR46-HVP2	66253319954	32A46-IVBE	66253364300			
	•	1/-	3SGR60-HVP2	66253319956	32A46-KVBE	66253364362			
	1,800	1/-	5SG46-IVS	66253364102	32A60-JVBE	66253364364			
	1,800	1/-	5SG46-JVS	66253364103	32A60-KVBE	66253364365			
	•	1/-	5SG60-IVS	66253364104	48A46-HVP2	66253319958			
	1,800	1/-	5SG60-JVS	66253364105					
14 x 2 x 5	2,320	1/-	3SGR46-GVP2	66253319936	48A46-HVP2	66253319941	1/-	25A46-HVP2	66253319945
Rec 1/S 8 x 1/2	2,320	1/-	3SGR46-HVP2	66253319937			1/-	38A46-HVP2	66253319949
	2,320						1/-	38A60-HVP2	66253319951
14 x 2 x 5	1,800	1/-			32A60-KVBE	66253364390			
Rec 1/S 8 x 1	1,800	1/-			32A60-LVBE	66253364525			
Type 06 Straight Cup									
3-1/2 x 1-1/2 x 1/2	6,550						1/10	38A60-KVBE	66243529372
Rim 1/2" Back 1/2"									
100mm x 50mm x 20mm	6,550						1/10	38A80-JVBE	66243530429
Rim 10mm									
Back 13mm									
4 x 1-1/2 x 1/2	5,730	1/10			32A60-KVBE	66243530218			
Rim 1/2" Back 1/2"									
4 x 1-1/2 x 1-1/4	5,730						1/10	38A60-KVBE	66243530221
Rim 1/2" Back 1/2"									
4 x 2 x 20mm	5,730						1/10	38A80-JVBE	66243530523
Rim 3/8" Back 1/2"									
5 x 1-1/2 x 1-1/4	4,585	1/10			32A46-KVBE	66252830832	1/10	38A46-KVBE	66252830842
Rim 3/8" Back 3/8"	4,585	1/10			32A60-JVBE	66252830837		38A60-KVBE	66252830846
Face Y (ME19243)	4,585	1/10			32A60-KVBE	66252830838			
5 x 2 x 5/8	4,585	1/10			32A60-JVBE	66252830987			
Rim 1/2" Back 1/2"									
6 x 1-1/2 x 1/2	3,820	1/10			32A46-KVBE	66252838458			
Rim 1" Back 1/2"									
6 x 2 x 1-1/4	3,820	1/10			32A46-IVBE	66252838544	1/10	38A60-KVBE	66252838486
Rim 1/2" Back 1/2"	3,820	1/10			32A60-JVBE	66252838538			
7 x 2 x 1-1/4	3,275	1/8			32A46-JVBE	66252942856			
Rim 1/2" Back 1/2"									
9-1/2 x 1-1/2 x 1-1/2	2,415						1/-	53A46-LVBE	66253149136
Rim 1-1/2" Back 5/8"									
10 x 4 x 1-1/2	2,295						1/-	38A46-IVBE	66253161797
Rim 1-1/4" Back 1"									
Tape Wound									
12 x 2-1/2 x 7	1,910	1/-			32A46-LVBE	66253263614			
Rim 1-1/2" Back 7/8"									
Type 07 Recessed Two Sides									
12 x 2 x 3	2,070	1/-			32A46-IVBE	66253263588			
Rec 2/S 5-1/2 x 3/8									
12 x 2 x 3	2,070	1/-			32A46-HVBE	66253263590			
Rec 2/S 7-1/4 x 1/2	2,070	1/-			32A46-JVBE	66253263348			
12 x 2 x 5	2,070	1/-			32A46-IVBE	66253263594			
Rec 2/S 7-1/4 x 1/2									
12 x 2 x 5	2,070	1/-	5SG46-JVS	66253209930	32A46-HVBE	66253263591	1/-	38A46-IVBE	66253263600
Rec 2/S 7-1/2 x 1/2	2,070	1/-			32A46-HVBEP	66253263603			
	2,070	1/-			32A46-JVBE	66253263483			
	2,070	1/-			32A46-KVBE	66253263596			
	2,070	1/-			32A60-IVBE	66253263597			

• 14" TYPE 05 WHEEL MAXIMUM RPM: NORPOR VP2 WHEELS = 2,320; ALL OTHERS = 1,800





Vitrified Wheels For Steel Applications CONTINUED

AVAILABILITY



TIER:
BRAND:
TRADENAME:
ABRASIVE:

BEST	BETTER	GOOD
Norton	Norton	Norton
NORTON SG	32A	38A
Ceramic Alumina	Aluminum Oxide	Aluminum Oxide

SIZE (D x T x H)	MAX. RPM	MIN./STD. PKG.	SPEC.	PART #	SPEC.	PART #	MIN./STD. PKG.	SPEC.	PART #
Type 11 Flaring Cup 									
3/2-1/4 x 1-1/4 x 3/4	7,640	1/10			32A60-JVBE	66243529183	1/10	38A60-JVBE	66243529197
Rim 1/4" Back 3/8"	7,640	1/10			32A60-KVBE	66243529187			
Face Z (ME21560)									
3-1/2/2-3/4 x 1-1/2 x 1-1/4	7,640	1/10			32A60-KVBE	66243529358			
Rim 1/4" Back 3/8"									
Face Z (ME24327)									
4/3 x 1-1/2 x 1-1/4	5,730	1/10	5SG46-IVSP	66243530127	32A46-IVBE	66243530240	1/10	38A46-KVBE	66243530378
Rim 1/4" Back 1/2"	5,730	1/10	5SG46-KVS	66243530342	32A46-KVBE	66243530246	1/10	38A60-JVBE	66243530387
Face Z (ME19237)	5,730	1/10	5SG60-JVS	66243530415	32A60-JVBE	66243530256	1/10	38A60-KVBE	66243530390
	5,730	1/10	5SG60-LVS	66243530417	32A60-KVBE	66243530361	1/10	38A80-JVBE	66243530393
	5,730	1/10	5SG80-JVS	66243530419	32A80-KVBE	66243530368	1/10	38A80-KVBE	66243530395
	5,730	1/10	5SG80-KVS	66243530420					
4-1/2/3-3/4 x 2 x 1-1/4	5,730	1/10			32A46-KVBE	66252830539			
Rim 1/4" Back 1/2"									
(ME20115)									
5/3-3/4 x 1-3/4 x 1-1/4	4,585	1/5	5SG46-KVS	66252803291	32A46-JVBE	66252830858	1/5	38A46-KVBE	66252830971
Rim 1/4" Back 1/2"	4,585	1/5	5SG60-KVS	66252830737	32A46-KVBE	66252830859	1/5	38A60-JVBE	66252830973
Face Z (ME21563)	4,585	1/5	5SG60-LVS	66252830736	32A60-JVBE	66252830962	1/5	38A60-KVBE	66252830975
	4,585	1/5			32A60-KVBE	66252830964			
6/4-1/2 x 2 x 1-1/4	3,820	1/5			32A46-JVBE	66252838491	1/5	38A46-KVBE	66252838495
Rim 3/8" Back 1/2"	3,820	1/5			32A46-KVBE	66252838528	1/5	38A60-KVBE	66252838497
Face Z (ME19241)	3,820	1/5			32A60-JVBE	66252838492			
7/5 x 2 x 1-1/4	3,275	1/8			32A46-JVBE	66252942959	1/8	38A46-HVBE	66252942963
Rim 3/4" Back 1/2"									
(ME19242)									
Type 12 Dish 									
4 x 1/2 x 3/4	6,207	1/10			32A60-KVBE	66243530067			
(ME19226)									
6 x 1/2 x 1-1/4	4,140	1/10	5SG60-LVS	66252836574	32A46-JVBE	66252836860	1/10	38A60-JVBE	66252836977
(ME19229)	4,140	1/10			32A60-JVBE	66252836966			
6 x 3/4 x 1-1/4	4,140	1/10	5SG60-KVS	66252837771	32A46-KVBE	66252837732			
(ME19230)	4,140	1/10			32A60-JVBE	66252837734			
	4,140	1/10			32A60-KVBE	66252837735			
7 x 1/2 x 1-1/4	3,600	1/10			32A46-KVBE	66252941644			
(ME13717)	3,600	1/10			32A60-KVBE	66252941647			
8 x 3/4 x 1-1/4	3,600						1/10	38A60-KVBE	66253044319
(ME19231)									
10 x 1 x 1	2,485	1/-			32A54-JVBE	66253161196			
(ME38702)									
10 x 1 x 1-1/4	2,485	1/-			32A54-JVBE	66253161197			
(ME38702)									
Type 20 Concave One Side 									
14 x 1-1/2 x 5	1,800	1/-	5SG60-JVS	66253302265	32A60-JVBE	66253364250			
Concave from Periphery	1,800	1/-			32A60-KVBE	66253364332			
1/2" Deep to 8" Flat Spot	1,800	1/-			32A60-LVBE	66253364375			
Type 35 Plate Mounted Disc 									
9 x 2 x 4-15/16	2,550	1/-			32A46-MVBE	66253049115			
Rim 2-1/32" (ME31130)	2,550	1/-			32A60-J25VCF2	66253006557			
Plate A47248	2,550	1/-			32A70-JVBEP	66253049112			



CATEGORY DEFINITION

These sharp silicon carbide, vitrified wheels are used for grinding non-steel applications.

APPLICATIONS: Use 39C (green silicon carbide) for cemented carbides, titanium, metal matrix composites and plasma sprayed materials.

Use 37C (black silicon carbide) on 300 series stainless steels, irons, nonferrous metals (aluminum, brass, bronze and copper) and non-metallic materials (stone, marble, rubber, ceramics and glass).

SHAPES: Type 01 Straight, Type 02 Cylinder, and Type 05 Recessed 1 Side

SIZE RANGE: 3" – 14" diameter

GRIT RANGE: 24 – 120

ABRASIVE GRAIN: 39C Green Silicon Carbide, 37C Black Silicon Carbide

Vitrified Wheels For Non-Steel Applications

AVAILABILITY

TIER:	GOOD
BRAND:	Norton
TRADENAME:	39C / 37C
ABRASIVE:	Silicon Carbide

SIZE (D x T x H)	MAX. RPM	MIN./STD. PKG.	SPEC.	PART #
Type 01 Straight				
3 x 1/2 x 1/2	10,825	10/50	37C60-MVK	66243529041
3 x 1 x 1/2	10,825	1/30	37C60-MVK	66243529166
	10,825	1/30	37C80-HVK	66243529170
	10,825	1/30	37C80-MVK	66243529171
	10,825	1/30	37C100-HVK	66243529172
	10,825	1/30	37C100-MVK	66243529070
3-1/2 x 1-1/2 x 7/8 (ME622)	7,095	1/10	37C24-SVK	66243529339
	7,095	1/10	37C30-SVK	66243529338
4 x 1/2 x 1/2	8,120	1/10	37C60-MVK	66243529960
	8,120	1/10	39C100-IVK	66243530064
6 x 1/2 x 1-1/4	4,140	1/10	39C60-IVK	66252836706
	4,140	1/10	39C80-IVK	66252836816
	4,140	1/10	39C100-IVK	66252836827
	4,140	1/10	39C120-IVK	66252836836
6 x 3/4 x 1-1/4	4,140	1/10	39C60-IVK	66252837584
	4,140	1/10	39C80-IVK	66252837598
	4,140	1/10	39C100-IVK	66252837717
6 x 1 x 1-1/4	4,140	1/10	39C60-IVK	66252838161
	4,140	1/10	39C80-IVK	66252838173
	4,140	1/10	39C100-IVK	66252838173
7 x 1/4 x 1-1/4	3,600	1/10	39C80-JVK	66252940007
	3,600	1/10	39C100-IVK	66252940109
	3,600	1/10	39C120-IVK	66252940111
7 x 1/2 x 1-1/4	3,600	1/10	37C46-JVK	66252941488
	3,600	1/10	37C60-OVK	66252941498
	3,600	1/10	39C60-IVK	66252941609
	3,600	1/10	39C60-JVK	66252941611
	3,600	1/10	39C60-KVK	66252941613
	3,600	1/10	39C80-IVK	66252941617
	3,600	1/10	39C80-JVK	66252941618
	3,600	1/10	39C100-HVK	66252941622
	3,600	1/10	39C100-IVK	66252941624
	3,600	1/10	39C120-IVK	66252941632 B
7 x 3/4 x 1-1/4	3,600	1/10	39C80-JVK	66252942096
	3,600	1/10	39C100-JVK	66252942104
7 x 1 x 1-1/4	3,600	1/10	39C60-IVK	66252942666
	3,600	1/10	39C80-IVK	66252942413
	3,600	1/10	39C120-IVK	66252942416
8 x 1/4 x 1-1/4	3,600	1/10	39C80-IVK	66253014526
	3,600	1/10	39C80-IVK	69936664144
	3,600	1/10	39C60-IVK	66253044013
8 x 3/8 x 1-1/4	3,600	1/10	39C80-IVK	66253044015
	3,600	1/10	39C100-IVK	66253044017 B
	3,600	1/10	39C60-JVK	66253044312
8 x 3/4 x 1-1/4	3,600	1/10	39C80-IVK	66253350645
	3,600	1/10	39C100-IVK	66253044314

AVAILABILITY

TIER:	GOOD
BRAND:	Norton
TRADENAME:	39C / 37C
ABRASIVE:	Silicon Carbide

SIZE (D x T x H)	MAX. RPM	MIN./STD. PKG.	SPEC.	PART #
Type 01 Straight				
8 x 1 x 1-1/4	3,600	1/10	39C60-JVK	66253044770
	3,600	1/10	39C80-IVK	66253044425 B
	3,600	1/10	39C100-IVK	66253044379
10 x 1 x 3	2,485	1/-	39C60-JVK	66253160348
10 x 1-1/2 x 2	2,485	1/-	39C60-JVK	66253161640
12 x 1 x 3	2,070	1/-	39C60-IVK	66253262985
12 x 1 x 5	2,070	1/-	39C60-IVK	66253262884
	2,070	1/-	39C80-JVK	66253262988
14 x 1 x 5	1,800	1/-	39C60-JVK	66253364206
	1,800	1/-	39C80-JVK	66253364208
14 x 1-1/2 x 5	1,800	1/-	39C60-JVK	66253364242
14 x 2 x 5	1,800	1/-	39C60-JVK	66253364322
Type 02 Cylinder				
6 x 1 x 4	3,600	1/10	39C60-IVK	66252838322
Rim 1"	3,600	1/10	39C60-JVK	66252838324
Plate A47466	3,600	1/10	39C80-IVK	66252838327
	3,600	1/10	39C100-IVK	66252838330
6 x 1-1/4 x 4	3,600	1/10	39C120-IVK	66252838193
	3,600	1/10	39C60-IVK	66252838345
Rim 1"				
Plate A47466				
7 x 1-1/2 x 5	3,600	1/8	39C60-IVK	66252942848
Rim 1"				
Plate A39027				
10 x 2 x 7	2,100	1/-	39C60-HVK	66253161675
Rim 1-1/2"	2,295	1/-	39C60-JVK	66253161678
Plate A83831	2,295	1/-	39C120-IVK	66253161784
14 x 4 x 11	1,640	1/-	39C60-JVK	66253364657
Rim 1-1/2"				
Plate A52814				
Tape Wound				
Type 05 Recessed One Side				
14 x 1-1/2 x 5	1,800	1/-	39C60-IVK	66253364328
Rec 1/S 8 x 1/2				

B = BEST SELLER; PERFORMS WELL IN A VARIETY OF APPLICATIONS FOR MANY SATISFIED CUSTOMERS

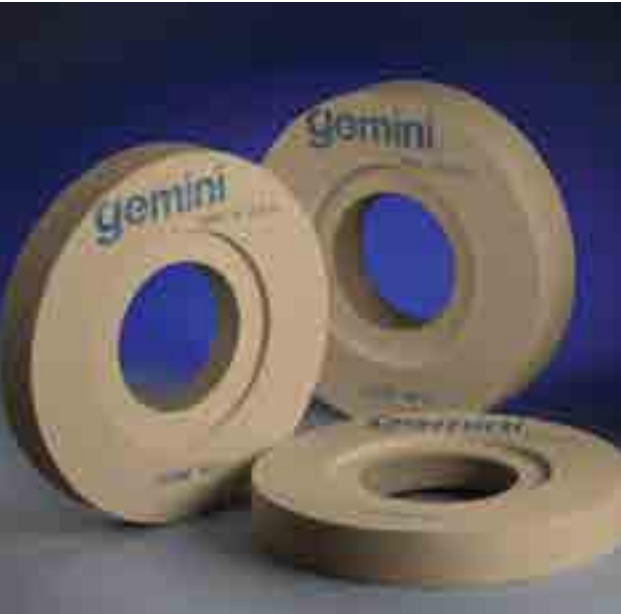

CATEGORY DEFINITION

Large surface grinding wheels are generally used to grind flat stock or flat surfaces within a workpiece. These wheels are typically used on horizontal spindle machines. Applications can vary from heavy, rapid stock removal to precision tolerance operations.

- APPLICATIONS:**
- Producing flat stock
 - Grinding large molds and dies
 - Sharpening knives, blades and cutlery
 - Manufacturing broaches
- SHAPE:** Type 07 Recessed 2 Sides
- SIZE RANGE:** Stock: 20" diameter
2" – 6" thickness
- ABRASIVE GRAIN:** Aluminum Oxide

CROSS REFERENCE GUIDE

	GOOD
NORTON	Gemini
Camel	91A
Cincinnati Milacron	29A, 97A
Radiac	WAA, 97A, 45A

FEATURED PRODUCTS

NORTON GEMINI WHEELS

GOOD CHOICE WHEN A BROAD RANGE OF PARTS ARE GROUND ON ONE MACHINE

FEATURES	BENEFITS
■ Specially blended aluminum oxide abrasive for many surface grinding applications	■ Consistent performance at an economical price
■ Porous bond	■ Faster grinding rates remove stock; lower rates produce finer finishes
■ Versatile	■ Cool cutting on medium to wide contact areas; high chip clearance and stock removal
	■ Ideal when a broad range of tool steel parts are ground on one machine

AVAILABILITY

SIZE (D x T x H)	MAX. RPM	STD. PKG.	TIER: GOOD	
			TRADENAME: NORTON GEMINI	ABRASIVE: Aluminum Oxide
			SPEC.	PART #
Type 07 Recessed Two Sides				
20 x 2 x 8	1,625	1	Gemini 59A46-I	66253246949
Recess 2/S 11-1/2 x 1/2	1,625	1	Gemini 46-G	66253246953
20 x 3 x 8	1,625	1	Gemini 46-G	66253246972
Recess 2/S 11-1/2 x 1/2				
20 x 3 x 10	1,625	1	Gemini 59A46-I	66253058315
Recess 2/S 12-1/4 x 3/4				
20 x 3 x 10	1,625	1	Gemini 36-J	66253246980
Recess Side A 12-1/2 x 1	1,625	1	Gemini 46-D	66253246988
Recess Side B 12-1/2 x 1/2	1,625	1	Gemini 46-I	66253246978
20 x 6 x 10	1,625	1	Gemini 59A46-I	66253058320
Recess 2/S 12-1/4 x 1				

FOR ADDITIONAL STOCK TYPE 07 LARGE SURFACE GRINDING WHEELS REFER TO THE CYLINDRICAL WHEELS SECTION OF THIS CATALOG.

There are many more sizes and specifications available made-to-your-order. Contact your Norton representative with your custom requirements.



CATEGORY DEFINITION

Surface grinding segments are generally used to grind flat stock or flat surfaces within a workpiece. The segment moves over the workpiece in a flat plane or vice versa. Applications can vary from heavy, rapid stock removal to precision tolerance operations.

- APPLICATIONS:**
- Vertical spindle surface grinding
 - Grinding large molds, dies and plates
 - Producing flat stock
 - Sharpening knives, blades, cutlery
- ABRASIVE GRAIN:** Ceramic Alumina, Aluminum Oxide

MATERIAL-TO-PRODUCT RECOMMENDATION GUIDE

MATERIAL	HEAVY-DUTY	GENERAL-DUTY
Aluminum	86A30-E20VTX2	Norton Gemini 30-E
Bronze (hard)		Norton Gemini 30-G
Cast Iron	QuantumX 20-G	Norton Gemini 30-G
Hastalloy	86A24-G20VTX2	Norton Gemini 30-E
Inconel	QuantumX 30-F	Norton Gemini 30-E
Hardened Steel	QuantumX 20-G	Norton Gemini 30-E
High Speed Steel	QuantumX 20-G	Norton Gemini 30-E
Soft Steel	86A24-G20VTX2	Norton Gemini 30-G
Stainless Steel 300	86A30-E20VTX2	Norton Gemini 30-E
Stainless Steel 400	86A30-E20VTX2	Norton Gemini 30-F

TROUBLESHOOTING GUIDE

PROBLEM	CORRECTION
Segment acting too hard	Increase rate of downfeed Increase table rotation speed (watch amp-meter) Dress more frequently Consider reducing area of table load
Segment acting too soft	Decrease rate of downfeed Decrease table rotation speed Check for abnormal machine vibration
Glazing and/or burning	Choose a softer grade Increase table speed (watch amp-meter)

TECHtip

- Choose as coarse a grit size as possible in order to remove stock as quickly as possible (In big chips).
- To maximize production, choose the hardest grade possible that will not overload the machine.



It is the user's responsibility to refer to and comply with ANSI B7.1

SEGMENT BLUEPRINTS

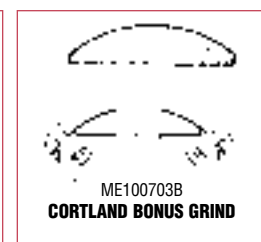
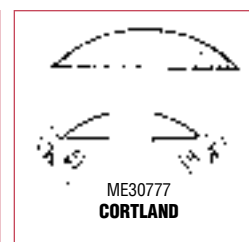
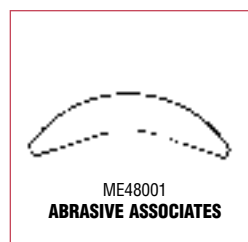
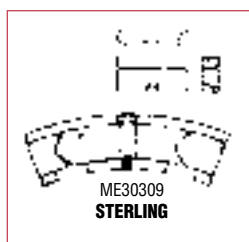
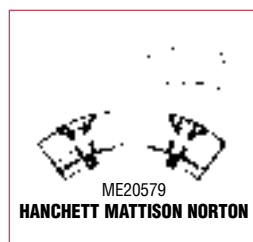

FEATURED PRODUCTS



EXPANDED OFFERING

NORTON QUANTUM AND QUANTUMX CERAMIC ALUMINA SEGMENTS

BEST CHOICE FOR ALL LOW-, MEDIUM-, AND HIGH-FORCE APPLICATIONS RANGING FROM CAST IRON, TO STAINLESS STEEL AND HARD-TO-GROUND ALLOYS

FEATURES

- Revolutionary, engineered ceramic grain shape and chemistry with proven bond technology
- Perform well on old and new machines
- NEW! QuantumX with Vitrium³ bond

BENEFITS

- Versatile; for applications ranging from cast iron, to stainless steel and hard-to-grind alloys
- 33% to 100% longer life versus competitive ceramic products
- 30%+ higher metal removal rate
- 15%+ lower threshold power
- Lowest total grinding costs
- The newest, strongest bond in the Norton portfolio: patented pore-induced construction; for all low-, medium- and high-force applications; excels on hard-to-grind aerospace alloys and large areas of contact; exceptional form and corner-holding



EXPANDED OFFERING

NORTON 86A SEGMENTS

BETTER CHOICE FOR VERSATILE, CONSISTENT PERFORMANCE

FEATURES

- Sharper aluminum oxide abrasive
- NEW! VTX2 Vitrium 3 bond

BENEFITS

- Cooler cutting
- The newest, strongest bond in the Norton portfolio: patented pore-induced construction; for all low-, medium- and high-force applications; excels on hard-to-grind aerospace alloys and large areas of contact; exceptional form and corner-holding



NORTON GEMINI SEGMENTS

GOOD CHOICE WHEN A BROAD VARIETY OF PARTS ARE GROUND ON ONE MACHINE

FEATURES

- Quality aluminum oxide abrasive blend

BENEFITS

- Excellent value for general purpose use, and for the account where initial price is a main purchasing consideration

AVAILABILITY

		TIER:		BEST		BETTER		GOOD		
		TRADENAME:		NORTON QUANTUM		NORTON 86A		NORTON GEMINI		
		ABRASIVE:		Ceramic Alumina		Aluminum Oxide		Aluminum Oxide Blend		
WIDTH	THICK	HEIGHT	BLUEPRINT NO.	STD. PKG.	SPEC.	UPC NO.	SPEC.	UPC NO.	SPEC.	UPC NO.
5	1-1/2	6	ME20579	8	QUANTUMX 20-G	66253350603	86A24-G20VTX2	66253350601	Gemini 30-E	66253050295
				8	QUANTUMX 20-H	66253350604	86A24-H20VTX2	66253350602	Gemini 30-F	66253050297
				8			86A30-F12VBEP	61463650273	Gemini 30-G	66253050299
6-13/16	1-1/2	6	ME30309	8			86A24-G20VTX2	66253350595		
				8			86A24-H20VTX2	66253350596		
11	2-1/8	6	ME48001	5			86A24-G20VTX2	66253350586		
				5			86A24-H20VTX2	66253350590		
11-1/4	2-1/4	6	ME30777	5	QUANTUMX 20-G	66253350607	86A24-E12VBEP	61463650279	Gemini 30-E	69936699706
				5	QUANTUMX 20-H	66253350608	86A24-G20VTX2	66253350605	Gemini 30-F	69936699709
				5	3NQP36-G12VSP	66253251527	86A24-H20VTX2	66253350606	Gemini 30-G	69936699710
				5			86A30-E12VBEP	61463650285	Gemini 30-H	66243447588
				5			86A30-F12VBEP	61463650287		
				5			86A30-G12VBEP	61463650289		
11-1/4	2-1/4	8	ME30777	5	QUANTUMX 20-G	66253350612	86A24-G20VTX2	66253350609	Gemini 30-E	69936699712
				5	QUANTUMX 20-H	66253350615	86A24-H20VTX2	66253350610	Gemini 30-F	69936699716
				5	QUANTUMX 30-E	66253387810	86A30-E20VTX2	66253387812	Gemini 30-G	69936699717
				5	QUANTUMX 30-F	66253387811	86A30-F20VTX2	66253387813	Gemini 30-H	66243447591
				5	3NQP30-F12VSP	66253238276			Gemini 30-I	66243447592
11-1/4	3	8	ME100703B	4	QUANTUMX 20-G	66253350623	86A24-G20VTX2	66253350617	Gemini 30-E	69936699725
				4	QUANTUMX 20-H	66253350624	86A24-H20VTX2	66253350621	Gemini 30-F	69936699727
				4	QUANTUMX 30-E	66253387808	86A30-E12VBEP	61463650301	Gemini 30-G	69936699728
				4	QUANTUMX 30-F	66253387809			Gemini 30-H	66243447594
				4	3NQP30-F12VSP	69083156473			Gemini 30-I	66243447595
				4					Gemini 30-K	66253344077
				4						
				4						
	1-5/8			10	Vitrified Burr Remover	61463650268*				

*MINIMUM QUANTITY = 2



CATEGORY DEFINITION

Cylindrical wheels are used most often when the part is held between centers and in chucks. There are three methods of cylindrical grinding: plunge, traverse, and angular.

- Plunge grinding – wheel is thrust or plunged into the part
- Traverse grinding – wheel moves across the part
- Angular grinding – wheel contacts the part at an angle

TYPICAL INDUSTRIES: Automotive, shipbuilding, engine building, bearing, land- and air-based turbine blades, and toolroom

SHAPE: Type 01 Straight, Type 05 Recessed One Side, and Type 07 Recessed 2 Sides

SIZE RANGE: 16", 18", 20", 24" and 30" diameter

ABRASIVE GRAIN: Ceramic Alumina and Aluminum Oxide

STATIONARY DRESSING TOOL RECOMMENDATIONS FOR CYLINDRICAL WHEELS

Grinding Wheel Diameter	Diamond Carat Weight	SINGLE POINT		MULTI-POINT (GRIT)					
		Tool Product/Part #	0° Angle	Tool Product/Part #	0° Angle	Shape	Tool Product/Part #	15° Angle	Shape
16" - 20"	3/4	BC7M7	66260195007	BC62	66260195012	1/4 x 1/2 Rect.	BC63	66260195013	1/4 x 1/2 Rect.
		NS7M7	66260195132	2A6D7	66260195046		2A6E7	66260195049	
21" +	1	BC10M7	66260195009	BC61	66260195011	1/4 x 3/4 Rect.	BC60	66260195010	1/4 x 3/4 Rect.
		NS10M7	66260195137	1A6A7	66260195031		1A6C7	66260195039	

NS SINGLE POINT DIAMOND TOOLS ARE RESETTABLE. BC DIAMOND TOOLS ARE NOT RESETTABLE. ALL TOOLS SPECIFIED ABOVE HAVE 7/16" DIAMETER SHANKS.

TROUBLESHOOTING GUIDE

PROBLEM	POSSIBLE CAUSES	SUGGESTED CORRECTION
Burn or cracks on workpiece	Wheel too hard Dress is too fine Nozzle not directing coolant properly Work speed too slow or wheel speed too fast Wheel feed too slow causing excess contact time	Try softer wheel or make wheel act softer (see Tech Tip on next page) Dress faster Redirect flow Adjust speeds Increase feed rate
Chatter marks on workpiece	Loose spindle, end play, bearing failure Work drive faults, out-of-truth plate Wheel too hard, poor truing, poor mounting	Check wheel spindle on assembly Check gear action, truth, drive on pin pressure Use softer grade; dress wheel correctly; secure mounting
Poor quality finish	Poor quality dressing Diamond insecurely held Misalignment of head and tail stocks Dirty coolant Scored workpiece centers	Reduce final depth of dress on wheel Check and replace diamond and secure properly Check for properly aligned workpiece Clean coolant frequently; use efficient filter Check and lap center holes as required

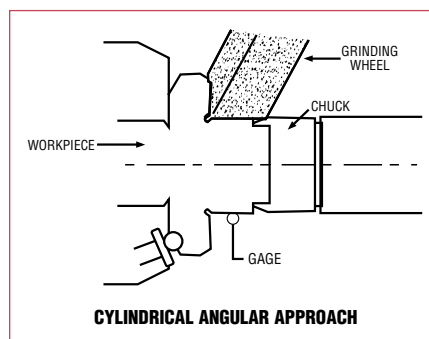
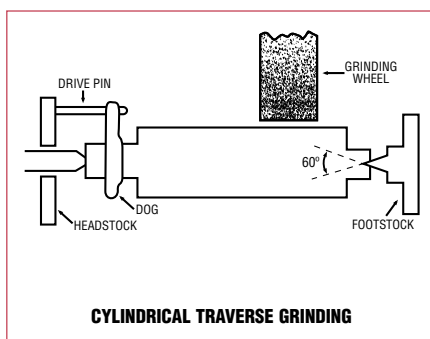
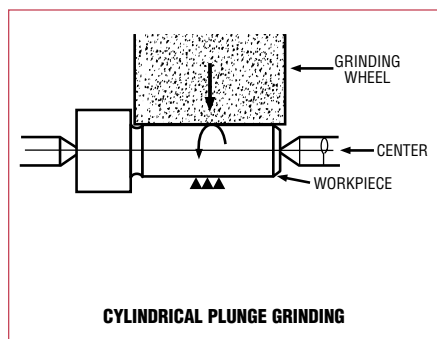

FEATURED PRODUCTS

NORTON 5SG

BEST CHOICE FOR HIGH PRODUCTIVITY, LOW TOTAL PER-PART GRINDING COST

FEATURES	BENEFITS
<ul style="list-style-type: none"> ■ Durable Norton SG seeded gel ceramic and aluminum oxide blend 	<ul style="list-style-type: none"> ■ High stock removal rates, excellent productivity, long wheel life, low overall grinding cost ■ 3X - 5X more life than aluminum oxide wheels
<ul style="list-style-type: none"> ■ Self-sharpening abrasive 	<ul style="list-style-type: none"> ■ Cool cutting; less burn, less dressing; very consistent performing wheel

NORTON 32A

BETTER CHOICE FOR MEDIUM TO HEAVY STOCK REMOVAL

FEATURES	BENEFITS
<ul style="list-style-type: none"> ■ Sharp monocrystalline aluminum oxide grain – the industry's most versatile abrasive 	<ul style="list-style-type: none"> ■ Free cutting on a wide range of applications and materials ■ Outstanding form holding

NORTON 86A

BETTER CHOICE FOR LONGER WHEEL LIFE

FEATURES	BENEFITS
<ul style="list-style-type: none"> ■ Premium abrasive; superior bond system 	<ul style="list-style-type: none"> ■ High grinding G-Ratios (metal removal/wheel wear) increase productivity ■ Decrease in dress frequency and/or dress compensation ■ Less wheel dressing means lower abrasive costs ■ Hold form for better part geometry
<ul style="list-style-type: none"> ■ Engineered for easy use 	<ul style="list-style-type: none"> ■ Grind cycles do not need to be altered ■ No special operator training is needed

NORTON 64A

GOOD CHOICE FOR VERSATILE PERFORMANCE AT AN ECONOMICAL PRICE

FEATURES	BENEFITS
<ul style="list-style-type: none"> ■ Specially blended aluminum oxide abrasive coupled with a superior bond 	<ul style="list-style-type: none"> ■ Will maintain high grinding rates without wheel breakdown
<ul style="list-style-type: none"> ■ Broad availability 	<ul style="list-style-type: none"> ■ Quick delivery on popular sizes
<ul style="list-style-type: none"> ■ Versatile 	<ul style="list-style-type: none"> ■ Engineered to grind a variety of materials

Contact your Norton representative with your custom cylindrical wheel requirements. There are many more sizes and specifications available made-to-your-order, including wheels made from Norton 55A and Quantum blank stock. Our revolutionary Norton Quantum and Vitrium³ bond ceramic wheels bring a quantum leap in technology to your operation. See 55A and Quantum Blank Stock FastTrack Service catalog sections for more details.

TECHtip**TO MAKE A WHEEL ACT SOFTER:**



- Increase work speed
- Increase traverse speed
- Increase infeed
- Decrease wheel speed
- Increase dresser traverse rate
- Increase depth of dress per traverse
- Dress more often

TO MAKE A WHEEL ACT HARDER:

- Decrease work speed
- Decrease traverse speed
- Decrease infeed
- Increase wheel speed (do not exceed MAX RPM marked on wheel)
- Dress at slower traverse rate
- Decrease depth of dress per traverse



It is the user's responsibility to refer to and comply with ANSI B7.1

AVAILABILITY		BEST		BETTER		GOOD	
TIER:		Ceramic / Aluminum Oxide		Aluminum Oxide		Aluminum Oxide	
ABRASIVE:							
SIZE (D x T x H)	STD. PKG.	SPEC.	PART #	SPEC.	PART #	SPEC.	PART #
Type 01 Straight 							
16 x 1 x 5	1	5SG60-JVS	66253467007	32A60-J8VBE	66253464836	64A60-K8V127	66253466722
	1			32A60-K5VBE	66253464837		
16 x 1 x 8	1			32A60-K5VBE	66253464826		
16 x 1-1/2 x 5	1	5SG60-KVS	66253467010	32A46-H8VBE	66253464925		
16 x 2 x 5	1			32A46-J8VBE	66253464995	64A60-K8V127	66253466721
	1			32A60-K5VBE	66253464960		
18 x 2 x 5	1					64A60-K8V127	66253466719
20 x 1 x 8	1			86A60-J8V127	69078608982	Gemini 46-H	66253246937
	1			86A80-J8V127	69078608983		
20 x 1-1/2 x 5	1			32A46-H8VBE	69078665382		
20 x 2 x 5	1					64A60-J8V127	69078666713
20 x 2 x 8	1			32A46-I8VBE	69078665433	64A60-K8V127	69078666712
	1			32A60-K5VBE	69078665490		
20 x 2 x 10	1					Gemini 36-J	66253246956
	1					Gemini 46-H	66253246957
	1					Gemini 60-J	66253246959
20 x 2 x 12	1			32A46-I8VBE	69078665455		
20 x 3 x 8	1					64A46-I8V127	69078666447
	1					64A60-J8V127	69078608140
24 x 2 x 12	1					64A60-K8V127	69083166710
	1					64A80-K8V127	69083166711
30 x 2 x 12	1					64A60-J8V127	69210466704
30 x 3 x 12	1					64A60-J8V127	69210466697
	1					64A60-K8V127	69210466698
30 x 4 x 12	1					64A60-J8V127	69210401774
Type 05 Recessed One Side 							
20 x 1-1/2 x 8	1					Gemini 46-H	66253246941
Rec 1/S 11-1/2 x 1/2							
Type 07 Recessed Two Sides 							
18 x 2 x 8	1			32A46-I8VBE	66253465110		
Rec 2/S 10-1/2 x 1/2							
20 x 2 x 8	1			32A46-I8VBE	69078665537		
Rec 2/S 11-1/2 x 1/2							
20 x 3 x 8	1			32A46-I8VBE	69078665686		
Rec 2/S 11-1/4 x 1/2							
20 x 3 x 8	1					Gemini 46-H	66253246969
Rec 2/S 11-1/2 x 1/2							
20 x 3 x 10	1			32A46-I8VBE	69078665575		
Rec 2/S 12-1/4 x 5/8							
20 x 3 x 10	1					Gemini 46-H	66253246991
Rec Side A 12-1/2 x 1							
Rec Side B 12-1/2 x 1/2							
20 x 6 x 10	1			32A46-I8VBE	69078665854		
Rec Side A 12-1/4 x 2							
Rec Side B 12-1/4 x 1							

FOR ADDITIONAL STOCK CYLINDRICAL WHEELS, SEE THE LARGE SURFACE GRINDING WHEEL SECTION OF THIS CATALOG

Contact your Norton representative with your custom cylindrical wheel requirements. There are many more sizes and specifications available made-to-your-order, including wheels made from Norton 55A and Quantum blank stock. Our revolutionary Norton Quantum and Vitrium³ bond ceramic wheels bring a quantum leap in technology to your operation. See 55A and Quantum Blank Stock FastTrack Service catalog sections for more details.



CATEGORY DEFINITION

Centerless grinding is a production process that produces extremely close tolerances on metal cylindrical forms or parts. Centerless grinding is used on a wide variety of workpieces. The key components in the process are the grinding wheel, the work rest blade (used to support the work) and the regulating or “feed” wheel (the drive mechanism for the workpiece).

- APPLICATIONS:**
- High production operations on large volume continuous grinding
 - Parts ranging from miniature roller bearings to train axles and bearings
 - Fastener and tool manufacturing
 - Steel mills
 - Automotive related components
 - Bearing
 - Machine tools
 - Aircraft
 - Turbine blades – land- and air-based

SHAPE: Centerless wheels: Type 01 Straight
Feed wheels: Type 01 Straight and Type 07 Recessed 2 Sides

SIZE RANGE: Centerless wheels: 16” – 24” diameter
Feed wheels: 12” and 14” diameter

ABRASIVE GRAIN: Aluminum Oxide, Aluminum Oxide/Silicon Carbide Blend

MATERIAL-TO-PRODUCT RECOMMENDATION GUIDE

APPLICATION	WHEEL SPECIFICATIONS
Alnico	64A60-KVCE, 55A60-KVS3, 32AC54-QB
Cast Iron	64A60-KVCE, 55A60-KVS3, 32AC54-QB
Hastalloy	64A60-LVCE
Inconel	64A60-LVCE
Stainless	64A60-KVCE
Stainless – 300 series	64A60-KVCE
Stainless – 400 series (commercial finish)	55A60-KVS3, 64A60-KVCE
Steel – Hard or Soft	
Less than 1/2" diameter	55A80-LVS3, 64A80-LVCE
5/8" to 2-1/2" diameter	55A60-KVS3, 64A60-LVCE
Over 2-1/2" diameter	55A60-KVS3, 64A60-LVCE, 32AC54-QB
High Speed (commercial finish)	64A60-KVCE, 55A60-KVS3, 32AC54-QB
High Speed (fine finish)	32AC90-QB

NOTE: GRADE, GRIT AND ABRASIVE TUNING MAY BE NECESSARY TO OBTAIN OPTIMUM PERFORMANCE

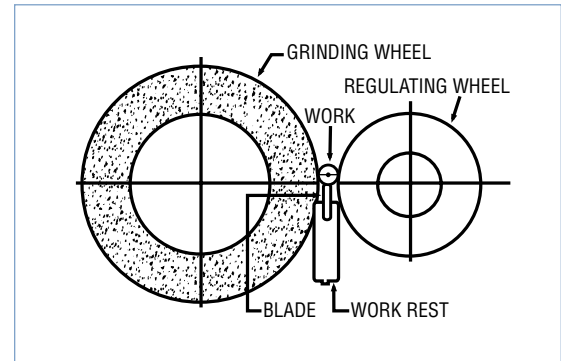

STATIONARY DRESSING TOOL RECOMMENDATIONS FOR CENTERLESS WHEELS

Grinding Wheel Diameter	Diamond Carat Weight	SINGLE POINT		INDEXABLE SINGLE POINT		MULTI-POINT (GRIT)	
		Tool Product # Part # 0° Angle	Tool Product # Part # 0° Angle	Tool Product # Part # 0° Angle	Shape	Tool Product # Part # 15° Angle	Shape
11" - 14"	1/2	BC5M7 66260195005	BCUD5 66260195025	BC65 66260195015	3/8 Round	BC63 66260195013	1/4 x 1/2
		NS5M7 66260195127	NSUD5 66260195163	2R6K7 66260195096		2A6E7 66260195049	Rectangle
15" - 20"	3/4	BC7M7 66260195007	N/A	BC62 66260195012	1/4 x 1/2	BC63 66260195013	1/4 x 1/2
		NS7M7 66260195132	NSUD7 66260195164	2A6D7 66260195046	Rectangle	2A6E7 66260195049	Rectangle
21" +	1	BC10M7 66260195009	N/A	BC61 66260195011	1/4 x 3/4	BC60 66260195010	1/4 x 3/4
		NS10M7 66260195137	NSUD10 66260195165	1A6A7 66260195031	Rectangle	1A6C7 66260195039	Rectangle

STATIONARY DRESSING TOOL RECOMMENDATIONS FOR FEED WHEELS

Feed Wheel Diameter	Tool Carat Weight	Tool Shank Diameter	INDEXABLE SINGLE POINT	
			Tool Product #	Tool Part #
Up to 14"	1/2	7/16"	NSUD5	66260195163

TECHtip

PROPER WHEEL MOUNTING

1. Thoroughly clean spindle and flange bearing area of all dirt and foreign material.
2. Inspect for worn, distorted or damaged areas on flanges and spindle.
3. If mounting a wide centerless wheel on a spindle (i.e., twin-grip), do not use grease or other petroleum lubricants. Use a silicone spray lubricant on the spindle to ease mounting the wheel, if necessary.
4. Ensure mount up arrow is at the top of the wheel. In the case of butted sets, assemble so that the arrow is formed across the top of the wheel face.
5. Ensure proper blotters are installed; one on each flange mating surface. Always use new blotters.
6. Install blotter flange and snug up the bolts only finger tight.
7. Using a torque wrench, tighten all bolts in an alternating pattern from side to side to 15 foot pounds.
8. Repeat the same tightening sequence, increasing the torque to 35 foot pounds.
 - a.) for wide wheels (18"-20"), torque the bolts at 45 to 50 foot pounds
 - b.) for narrower wheels (2"-12"), a torque of 35 foot pounds is sufficient
9. Retorque the flange bolts to specification after the first eight hours of operation.

- Use vitrified bond wheels for form holding and plunge grinding
- Use resinoid bond wheels for stock removal, long irregular parts and faster throughfeed grinding
- Vitrified Centerless Wheel Speeds:
 - 64A46-KVCE wheels: 6500 SFPM max. operating speed
 - All other vitrified centerless stock products: 8500 SFPM max. operating speed
 - Always check wheel speed markings on wheels before running wheel



It is the user's responsibility to refer to and comply with ANSI B7.1

TO MAKE A WHEEL ACT SOFTER:

- Increase work speed/regulating wheel speed
- Increase throughput speed/regulating wheel speed
- Increase infeed
- Decrease wheel speed
- Dress at a faster traverse rate

TO MAKE A WHEEL ACT HARDER:

- Decrease work speed/regulating wheel speed
- Decrease throughput speed/regulating wheel speed
- Decrease infeed
- Increase wheel speed (observe safe limits)

FEATURED PRODUCTS



55A-VS3

BETTER CHOICE WHEN ONE WHEEL IS USED TO GRIND SEVERAL DIFFERENT MATERIALS

FEATURES

- Advanced combination of monocrystalline 55A aluminum oxide and coolest cutting, high-speed, precise form holding Vitrium 3 VS3 Bond

BENEFITS

- Superior performance on centerless plunge and throughfeed, surface, grinders
- 2X+ the life of competitive aluminum oxide wheels
- Ideal for simple- to complex-shaped components
- Increased productivity; more quality parts at low cost per part

32AC

BETTER CHOICE WHEN ONE WHEEL IS USED TO GRIND SEVERAL DIFFERENT MATERIALS

FEATURES

- Aluminum oxide/silicon carbide abrasive blend in a strong resin bond

BENEFITS

- Ideal when one wheel is used to grind several different materials from high to low tensile strength



57A WITH FINE/HARD SIDE

GOOD FOR HARD-TO-GRIND FASTENERS

FEATURES

- Durable, cool cutting aluminum oxide abrasive with a strong vitrified bond
- 3/16" thick fine/hard side

BENEFITS

- Cool cutting with consistent stock removing performance on narrow to medium contact areas
- Provides good form holding while grinding stainless and Inconel fasteners

64A

GOOD CHOICE FOR GRINDING A VARIETY OF MATERIALS, ECONOMICALLY

FEATURES

- Specially blended aluminum oxide abrasive coupled with a superior vitrified bond
- Broad availability
- Versatile

BENEFITS

- Will maintain high grinding rates without wheel breakdown
- Quick delivery on popular sizes
- Engineered to grind a variety of materials

Centerless Wheels



AVAILABILITY

		TIER: BETTER		TIER: BETTER		TIER: GOOD	
		TRADENAME: CENTERLESS VITRIFIED WHEELS		TRADENAME: CENTERLESS RESINOID WHEELS		TRADENAME: CENTERLESS VITRIFIED WHEELS	
		ABRASIVE: Aluminum Oxide		ABRASIVE: Aluminum Oxide/Silicon Carbide		ABRASIVE: Aluminum Oxide	
SIZE (D x T x H)	STD. PKG.	SPEC.	PART #	SPEC.	PART #	SPEC.	PART #
Type 01 Straight							
16 x 4 x 10	1					57A80-L8VCN	66253465001
20 x 2 x 12	1					53A60-K8VCN	69078665347
20 x 4 x 12	1					64A60-KVCE	69078666723
	1					64A80-LVCE	69078666727
20 x 6 x 12	1	55A60-KVS3	66253387817	32AC54-QB	69078666545	64A60-KVCE	69078666729
	1	55A80-LVS3	66253387815			Gemini 60-L	66253246994
20 x 8 x 12	1	55A60-KVS3	66253387819	32AC54-QB	69078666546	64A60-KVCE	69078666748
	1	55A80-LVS3	66253387818			64A60-LVCE	69078666749
	1					64A80-KVCE	69078666751
	1					64A80-LVCE	69078666752
	1					Gemini 54-J	66253247001
24 x 1-1/2 x 12	1					57A 80/120 O/Q	66253193575
w/ 3/16" fine/hard layer	1					57A 80/120 P/R	66253354449
24 x 2-1/2 x 12	1					57A 80/120 O/Q	66253285629
w/ 3/16" fine/hard layer	1					57A 80/120 P/R	66253340540
24 x 3 x 12	1					64A60-K8V127	69083166708
24 x 6 x 12	1	55A80-LVS3	66253387821	32AC54-QB	69083166547	Gemini 60-K	66253247047
24 x 8 x 12	1	55A60-KVS3	66253387827	32AC54-QB	69083166548	64A60-LVCE	69083166767
	1	55A80-LVS3	66253387825				
24 x 10 x 12	1	55A60-KVS3	66253387830	32AC54-QB	69083166549	64A80-KVCE	69083166788
	1	55A80-LVS3	66253387828				
24 x 20 x 12	1			32AC54-QB	69083166552		
Composed of 2	1			32AC54-SB	69083166553		
Wheels							
10" Thick (ME90362)							

Rubber Bond Feed Wheels

AVAILABILITY

		TIER: BETTER	
		ABRASIVE: Aluminum Oxide	
SIZE (D x T x H)	STD. PKG.	SPEC.	PART #
Type 01 Straight			
12 x 2 x 5	1	57A80-RR51	66253222840
Type 07 Recessed Two Sides			
12 x 4 x 5	1	57A80-RR51	66253222844
Rec 2 Sides 7-1/2 x 1/2			
12 x 6 x 5	1	57A80-RR51	66253222846
Rec Side A 7-1/2 x 1-1/2			
Rec Side B 7-1/2 x 1/2			
12 x 6 x 5	1	57A80-RR51	66253222847
Rec 2 Sides 7-1/2 x 1-1/2			
12 x 8 x 5	1	57A80-RR51	66253222850
Rec Side A 7-1/2 x 2-1/2			
Rec Side B 7-1/2 x 1-1/2			
14 x 8 x 5	1	57A80-RR51	66253322859
Rec Side A 8 x 2			
Rec Side B 8 x 1-1/2			
14 x 20 x 6	1	57A80-RR51	66253322196
Rec 2 Sides 8-1/2 x 1-1/2			
Butted Feed Wheels			
Composed of 2 Wheels			
10" Thick (ME91512)			

Plastic Bond Feed Wheels

AVAILABILITY

		TIER: BETTER	
		ABRASIVE: Aluminum Oxide	
SIZE (D x T x H)	STD. PKG.	SPEC.	PART #
Type 07 Recessed Two Sides			
12 x 8 x 5	1	57A80-RP4	66253222199
Rec Side A 7-1/2 x 2-1/2			
Rec Side B 7-1/2 x 1-1/2			

There are many more sizes and specifications available made-to-your-order, including wheels made from our blank stock FastTrack Service for rush orders. Contact your Norton representative with your custom centerless requirements.



CATEGORY DEFINITION

Norton creepfeed wheels are the best performing creepfeed wheels in the industry. These high-performance blank stock wheels can be altered to your dimensional requirements.

- APPLICATIONS:** Heat-sensitive, porous grinding of difficult-to-grind alloys
- TYPICAL INDUSTRIES:** Aerospace, automotive, toolroom, gear, energy
- SIZE RANGE:** Blank Stock: 16" – 25" diameter
Finished Wheel: 14" – 25" diameter
- GRADE/POROSITY:** C28 – F26
- ABRASIVE GRAIN:** Ceramic Alumina, Fused Aluminum Oxide

FEATURED PRODUCTS



NORTON QUANTUM X

BEST CHOICE FOR VERSATILITY, MAXIMUM PERFORMANCE, AND HIGHEST PRODUCTIVITY

FEATURES

- Leading Norton technologies produce the most free-cutting creepfeed wheel: patented pore-induced construction, Norton Quantum abrasive, and the newest, strongest Norton bond

BENEFITS

- Versatile; for all low-, medium- and high-force applications on hard-to-grind Inconel, titanium, and aerospace alloys
- Excel on large area of contact applications
- Exceptional form and corner-holding; 20+% less power draw
- Best MRR vs. all other ceramic creepfeed wheels
- Reduce grinding cycle times up to 50%



NORTON VORTEX

BETTER CHOICE FOR HEAT-SENSITIVE, POROUS GRINDING OF DIFFICULT-TO-GRIND ALLOYS

FEATURES

- High-performance, engineered, fused aluminum oxide abrasive, optimally spaced
- Highly porous and permeable

BENEFITS

- High metal removal rates; able to grind large areas of contact
- Exceptional part integrity and quality; superior surface finish
- Long wheel life: dramatically shorter grinding cycles = less wheel changes and more parts/wheel = high productivity

AVAILABILITY

TIER:

BEST

BETTER

TRADENAME:

NORTON QUANTUM X AND QUANTUM
Ceramic Unfinished Blank Stock

NORTON VORTEX
A/O Unfinished Blank Stock

SIZE (D x T x H)	SPEC.	UF BLANK PART #	SPEC.	UF BLANK PART #
Type 01 Straight 				
16 x 1 x 5	3NQX60-C28VTX2	00310438575		
	3NQX60-D28VTX2	00310425238		
	3NQX60-E24VTX2	00310425239		
16 x 3 x 5	3NQX60-C28VTX2	00310438656		
	3NQX60-D28VTX2	00310425240		
	3NQX60-E24VTX2	00310425241		
16 x 4 x 5			IPA60-D29VTX	00310312485
			IPA60-E26VTX	00310312486
16 x 5 x 5	3NQX60-D28VTX2	00310425242		
	3NQX60-E24VTX2	00310425243		
	3NQX60-C28VTX2	00310438657		
16 x 6 x 5	3NQX60-C28VTX2	00310438658		
	3NQX60-D28VTX2	00310425244		
	3NQX60-E24VTX2	00310425245		
20 x 1 x 8	3NQX60-C28VTX2	00310438658		
	3NQX60-D28VTX2	00310425244		
	3NQX60-E24VTX2	00310425245		
20 x 2-1/2 x 8			IPA60-E26VTX	00310303130
			IPA60-F17VTX	00310303131
			IPA80-D29VTX	00310303132
20 x 3 x 8	3NQX60-C28VTX2	00310438659		
	3NQX60-D28VTX2	00310425256		
	3NQX60-E24VTX2	00310425257		
20 x 4 x 8			IPA60-D29VTX	00310303133
			IPA60-E26VTX	00310303134
20 x 5 x 8	3NQX60-D28VTX2	00310425258		
	3NQX60-E24VTX2	00310425259		
20 x 6 x 8	3NQX60-C28VTX2	00310438660		
24 x 4 x 8			IPA60-C29VTX	03103925091
			IPA60-D29VTX	00310406547
			IPA60-F26VTX	00310303135
25 x 2-1/2 x 8	3NQ60-E24VCF3	00310404676	IPA60-E26VTX	00310404613
	3NQ60-E24VCF3	00310404614	IPA60-E26VTX	00310404678

KEY PROGRAM FEATURES

- Standard lead-time: 2 weeks
- Alteration Parameters:
 - Diameter may be altered to 2" smaller than the original blank stock diameter
 - Thickness may be altered to 1/2 the original blank stock thickness
 - Bore may be altered to these parameters 5" altered up to 8" max. 8" altered up to 12" max.



CATEGORY DEFINITION

The newest-generation ceramic Norton Quantum vitrified wheels deliver the highest productivity of any wheel in the marketplace. They will grind with superior results in many applications. They can be altered to your specific needs within two weeks of receipt of your order.

- APPLICATIONS:** Centerless plunge and throughfeed grinding
Surface grinding
Cylindrical grinding
- SIZE RANGE:** Blank Stock: 18" – 30" diameter
Finished Wheel: 16" – 30" diameter
- GRIT RANGE:** 60, 80, and 120
- GRADE RANGE:** I – M
- ABRASIVE GRAIN:** Ceramic Alumina

FEATURED PRODUCTS



NORTON QUANTUM

BEST CHOICE FOR VERSATILITY, MAXIMUM PERFORMANCE, AND COST SAVINGS

FEATURES

- Revolutionary, sharp, durable, engineered ceramic alumina grain shape and chemistry; highly-porous

BENEFITS

- Versatile; for all low-, medium- and high-force applications ranging from cast iron, to stainless steel and hard-to-grind Inconel and titanium
- Perform well on old and new machines
- 30%+ higher metal removal rate
- 15%+ lower threshold power
- Highest productivity; lowest total grinding cost

AVAILABILITY

TIER:

BEST

TRADENAME:

NORTON QUANTUM

Ceramic Unfinished Blank Stock

SIZE (D x T x H)	SPECIFICATION	UNFINISHED BLANK PART #
Type 01 Straight 		
18 x 1 x 5	3NQ80-K10VS	00310405993
18 x 2 x 5	3NQ80-K10VS	00310405994
18 x 3 x 5	3NQ80-K10VS	00310405995
20 x 1 x 8	3NQ80-K10VS	00310405985
20 x 1 x 12	3NQ80-K10VS	00310406017
	3NQ120-MVS	00310405924
20 x 2 x 8	3NQ80-K10VS	00310406036
20 x 3 x 8	3NQ80-K10VS	00310406037
20 x 6 x 12	3NQ80-L10VS	00310406018
20 x 8 x 12	3NQ80-L10VS	00310406026
24 x 1 x 8	3NQ80-K10VS	00310406034
24 x 1 x 12	3NQ80-K10VS	00310406038
24 x 2 x 8	3NQ80-K10VS	00310406035
24 x 2 x 12	3NQ80-K10VS	00310406029
24 x 3 x 8	3NQ60-J10VS	00310425121
	3NQ80-K10VS	00310406046
24 x 3 x 12	3NQ60-J10VS	00310425120
	3NQ80-K10VS	00310406030
24 x 6 x 12	3NQ80-L10VS	00310406031
24 x 8 x 12	3NQ80-L10VS	00310406032
24 x 10 x 12	3NQ80-L10VS	00310406033
30 x 2 x 12	3NQ80-I10VS	00310427211
	3NQ80-J10VS	00310406047
	3NQ80-K10VS	00310406048
30 x 3 x 12	3NQ60-I10VS	00310427212

There are many finished sizes and specifications available. Contact your local Norton distributor or salesperson with your size and specification requirements for quantity guidelines, quotations and helpful ordering instructions.

Please note "2-week delivery request" if needed, on your order.



CATEGORY DEFINITION

55A-VH blank stock wheels are competitively-priced, monocrystalline grain wheels specifically engineered for numerous carbon steel applications requiring moderate to heavy stock removal rates. They can be altered to your specific needs within two weeks of receipt of your order.

- APPLICATIONS:** Centerless plunge and throughfeed grinding
Surface grinding
Cylindrical grinding
- SIZE RANGE:** Blank Stock: 18" – 42" diameter
Finished Wheel: 16" – 42" diameter
- GRIT RANGE:** 60 – 120
- GRADE RANGE:** I – M
- ABRASIVE GRAIN:** Aluminum Oxide

FEATURED PRODUCTS



55A-VH

BETTER CHOICE FOR PRECISION GRINDING OF CARBON STEEL AND CAST IRON

FEATURES

- Advanced combination of monocrystalline 55A aluminum oxide abrasive and superior VH bond

BENEFITS

- Superior performance on centerless plunge and throughfeed, surface, and cylindrical grinders
- Up to 2X the life of competitive aluminum oxide wheels
- Ideal for simple- to complex-shaped components
- Increased productivity; more quality parts at lowest cost per part

AVAILABILITY

TIER:

BETTER

OTHER:

57A-VH

Aluminum Oxide Unfinished Blank Stock

SIZE (D x T x H)	GRIT	GRADE	UNFINISHED BLANK PART #
Type 01 Straight 			
18 x 1 x 5	80	K	00310404552
18 x 2 x 5	80	K	00310404554
18 x 3 x 5	80	K	00310404555
20 x 1 x 8	60	K	00310020910
20 x 1 x 12	100	K	00310302177
	120	K	00310302220
	120	M	00310064512
20 x 1-1/2 x 12	80	K	00310302221
	100	K	00310302222
20 x 2 x 8	80	K	00310020918
	100	K	00310020920
	120	M	00310064252
20 x 3 x 8	80	K	00310425116
20 x 3 x 12	80	K	00310425117
20 x 6 x 12	80	K	00310020965
24 x 1 x 8	80	K	00310021884
24 x 1 x 12	60	K	00310020921
	80	M	00310020923
24 x 1-1/4 x 12	60	M	00310302224
24 x 1-1/2 x 8	80	K	00310302223
24 x 1-1/2 x 12	80	K	00310302225
	80	M	00310302226
24 x 2 x 8	80	K	00310021885
24 x 2 x 12	60	K	00310020924
	80	I	00310020926
24 x 3 x 8	80	K	00310021757
24 x 5 x 12	60	L	00310302227
24 x 6 x 12	60	K	00310020968
24 x 8 x 12	100	K	00310302228
24 x 10 x 12	80	K	00310020972
30 x 2 x 12	60	L	00310020929
30 x 3 x 12	60	L	00310020930
42 x 1-1/2 x 12	60	M	00310020931

There are many finished sizes and specifications available. Contact your local Norton distributor or salesperson with your size and specification requirements for quantity guidelines, quotations and helpful ordering instructions.

Please note "2-week delivery request" if needed, on your order.



CATEGORY DEFINITION

Norton quality non-stock gear wheels are designed to produce high metal removal rates with less power draw. The blank stock wheels below comprise our FastTrack alteration service.

All Norton FastTrack wheels are altered on state-of-the-art CNC controlled machines and are finished using Saint-Gobain dressing wheels. The Saint-Gobain dressing wheels and machines give these wheels excellent accuracy and repeatability.

NEW! For 2015: Vitrium 3 VS3G bond wheels

Our revolutionary, exclusive bond platform provides unprecedented wheel performance and finished part accuracy across many precision grinding applications – while lowering process time and cost in three ways:

1. Coolest cutting with maximum chip clearance
2. Optimized precision profile delivers ultra radius accuracy
3. Able to run at higher operating speeds (maximizing your older and newer machines' performances)

SIZE RANGE: Blank Stock: 120mm – 450mm diameter
Finished Wheel: 115mm – 450mm diameter

GRIT RANGE: 60 – 100

ABRASIVE GRAIN: Ceramic Alumina and Aluminum Oxide

KEY PROGRAM FEATURES

- Standard lead time: 2 weeks
- Alteration Parameters:
 - Diameter may be altered to 2" smaller than the original blank stock diameter
 - Thickness may be altered to 1/2 the original blank stock thickness

AVAILABILITY

TIER:	BEST		BETTER	
TRADENAME:	QUANTUM; 3TGP; SG		BRGL – CERAMIC	
ABRASIVE:	Ceramic Unfinished Blank Stock		Unfinished Blank Stock	
SIZE (D x T x H)	SPECIFICATION	BLANK PART #	SPECIFICATION	BLANK PART #
Type O1 Straight				
Worm Profile Wheels				
220mm x 180mm x 76.2mm			BRGL80-GVPHS	00310048274
280mm x 160mm x 115mm	SG80-HVX	00310419856	X25A70-G16VPAP	00310410369
	NQ80-H8VS3G	00310448492	25A80-H8VS3G	00310448494
300mm x 125mm x 160mm	3NQ90-J10VH	00310394338		
350mm x 104mm x 160mm			BRGL100-GVPLS	00310066991
350mm x 125mm x 160mm	3NQ90-H10VS3G	00310448495	25A90-H10VS3G	00310448496
Single Rib Wheels				
120mm x 30mm x 20mm	3TGP80/3-G12VS3G	00310448502		
300mm x 30mm x 50.8mm	3TGP80/3-G12VS3G	00310448501		
300mm x 60mm x 50.8mm	3TGP80/3-G12VS3G	00310448500		
400mm x 50mm x 127mm	3TGP60-G20VSPF	00310404596		
400mm x 75mm x 127mm	3TGP60-G20VSPF	00310404597		
400mm x 100mm x 127mm	3TGP60-G20VSPF	00310404598		
450mm x 50mm x 127mm	3TGP80/3-G12VS3G	00310448499		
450mm x 100mm x 127mm	3TGP80/3-G12VS3G	00310448498		
450mm x 150mm x 127mm	3TGP80/3-G12VS3G	00310448497		



Gear blank stock alteration orders must include complete blueprint information. Please ask your Norton representative for appropriate blueprint worksheet to fill in:

Worm wheel blueprint worksheet: ME161508

Single rib wheel blueprint worksheet: ME161178

How to Read an Abrasive Product Specification

Conventional Grinding Wheels																	
32A			46			I			8			V			BE		
ABRASIVE			GRIT SIZE			GRADE			STRUCTURE			BOND TYPE			NORTON SYMBOL		
ALUMINUM OXIDE	CERAMIC ALUMINUM OXIDE	SILICON CARBIDE	ZIRCONIA ALUMINA	COARSE	MEDIUM	FINE	SOFT	MEDIUM	HARD	RELATIVE GRAIN SPACING	Resin = B Shellac = E Plastic = P Rubber = R Vitrified = V	Designates a variation or modification to bond.					
23A	3SGP	39C	4ZF	12	30	80	D	I	Q	2							
25A	3SGR	Crystolon	5ZF	14	36	90	E	J	R	4							
32A	3SGR	Crystolon	5ZF	16	46	100	F	K	S	5							
32AC (blend)	5SG	Masonry	AZ (blend)	20	54	120	G	L	T	6							
38A	BRG	BlueFire		24	60	150	H	M	U	8							
48A	SG	Charger			70	220		N	V	12							
53A	SXG	(blend)						O	Y	16							
55A	NorZon Plus	NZ						P	Z	19							
57A	(blend)	NZC (blend)								25							
U57A	NQ Quantum	NZIII								28							
64A	Targa	NZIV															
86A		NorZon															
90A		ZI															
Alundum																	
FabCut																	
India																	
Gemini																	
Metal																	
Vortex																	

Shelf Life and Proper Storage of Grinding Wheels

It has always been Saint-Gobain Abrasives recommendation that resinoid bonded grinding wheels be used within 2 years from the date of manufacture. This recommendation assumes that resinoid bonded grinding wheels have been stored under ideal storage conditions. It might be true that under ideal storage conditions resinoid bonded grinding wheels can survive without any degradation in strength for well over two years. However, it is always wise to suspect any wheels over two years old and have them reinspected or re-speed tested to determine if there has been any degradation in strength. If the wheels are stored under less than ideal conditions, they might have a much shorter shelf life depending upon the severity of storage conditions. These same comments also apply to rubber and shellac bonded grinding wheels.

As for vitrified grinding wheels, the shelf life is less influenced by humidity and adverse storage conditions as compared to resinoid, rubber or shellac, but even vitrified grinding wheels do not have an infinite shelf life. The best procedure and the best rule of thumb is to have any wheel that is two years old or older re-speed tested and reinspected to ensure it is fit for use. The procedure for having this done and the charges will be explained by our Customer Service Department, but the cost of shipping as well as the cost of re-inspection is the customer's responsibility. Also, any wheels rejected or otherwise lost in the re-inspection process will also be the responsibility of the customer.

Keep in mind, however, that this procedure is good to verify the reliability of a product but must not be performed until you are ready to consume the wheel. If wheels are sent back after the two year time frame for re-inspection and re-testing and then put back on the shelf, there is no telling how long they will be fit for use after that last inspection. Therefore, these wheels must be consumed as soon as is practical.

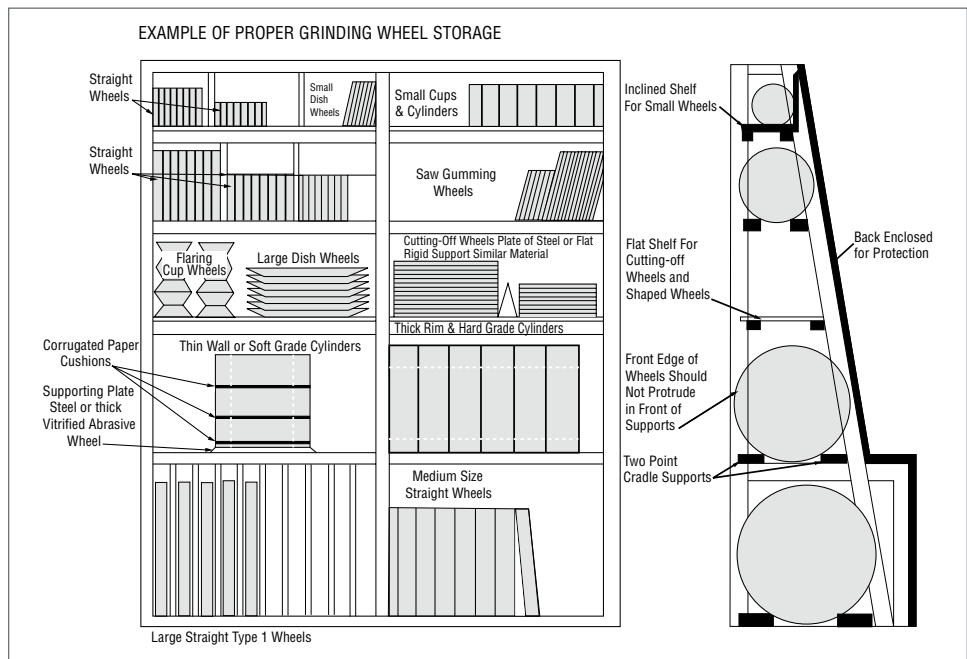



our dressing tools **MAKE THE PERFECT POINT**

The Norton full line of expertly-crafted stationary and rotary dressing tools - whether stock or custom-engineered - delivers your every application need. And, our expert resetting and relapping services renew used tools to reduce your "cost per dress."



Single Has Advantages

Our extensive single point tool offering leads the industry for resettable and non-resettable products, all abrasive types and the technology-leading "Indexable" tool design.

PanAmericanDistribution.com

Exceeding Conventional

Since Norton multi-point tools never need turning or resetting, they pay for themselves time and time again in dressing operations for all grinding wheel operations.

When Shape Matters

For intricate forms, tight tolerances, and the most difficult applications, Norton customized cup cutters and form tools can be precision lapped to meet a special shape and quality preference.

[Email: panamericandistribution@gmail.com](mailto:panamericandistribution@gmail.com)



CATEGORY DEFINITION

Our Norton offering is the industry's most comprehensive line of stock and made-to-order products to true (restore the wheel's profile) and dress (opening – to remove stock – or closing – to finish) the face of the wheel. In addition to these catalog stock stationary tools, Norton manufactures a full line of custom stationary tools, rotary diamond dressers and truing/dressing devices to meet all your specific application needs. Contact us at 1-800-438-4773.

- APPLICATIONS:** Truing and dressing conventional and superabrasive wheels, straight, step, radius and form dressing
- TOOL TYPES:** Stationary: Single Point, Toolroom, Multi-Point, Blade, Form, and Cluster Tools, and Truing Devices
- Rotary: Reverse Plated and Infiltrated Form Plunge Diamond Rolls, Diamond CNC Traversing Discs, and Dressing Spindles

DETERMINING THE BEST VALUE

- Remember that diamonds are a rare commodity—the larger the stone and the better the quality, the higher the initial cost. The key to successful diamond tool productivity and use is based on the “cost per dress.” Normally, higher quality diamonds and a proactive resetting program will result in the lowest “cost per dress.”
- In those situations where a resetting program is not feasible or low initial cost is the primary purchasing consideration, Norton offers a complete line of non-resettable tools.

RESETTING YOUR USED DIAMOND TOOLS

Resetting – Minimizing Your Cost

Buying a higher quality diamond is your best value, especially if you participate in a proactive resetting program. Although initial cost may be higher, the payback comes through several factors:

- Diamond durability, providing longer tool life
- Tighter form tolerances
- Consistent finish rates
- Resetting the diamond lowers the overall tooling cost

Used properly, the overall cost of a higher quality, resettable diamond will compare favorably with that of an inexpensive, non-resettable diamond. Initially, the best diamond point is selected for use. When returned, the next best diamond point is selected for resetting, and so on.

To ensure you get the best value for your diamond:

- Rotate the diamond tool ¼ turn periodically to maintain a sharp point
- Use proper flow of coolant to protect the diamond from heat which can create fracturing of the diamond
- Excessive wear on the diamond point may impact the ability to reset the diamond. The widest point of the diamond is referred to as the girth. The diamond girth is buried in a powder metal matrix. Using a diamond into the girth zone might impact the ability to reset other diamond points

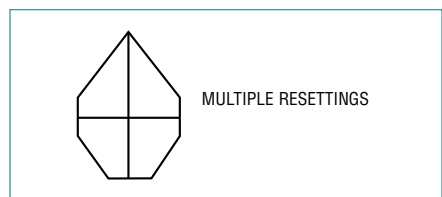
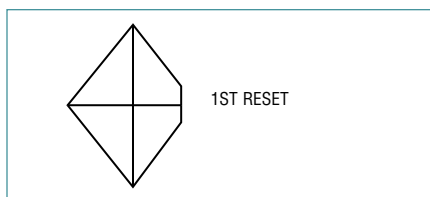
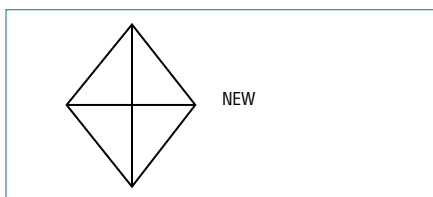

TECHtip

SELECTING THE CORRECT DIAMOND TOOL

To determine the type of Norton dressing tool to use, it is best to think about the desired shape of the wheel face. Finished wheel face shapes are generally categorized into six types, as illustrated below.

TYPICAL WHEEL FORMS DRESSED BY STATIONARY DIAMOND TOOLS

Look for the applicable wheel forms beside each product type to help you choose the correct product for your application.



STRAIGHT



TAPERED



CONVEX



CONCAVE

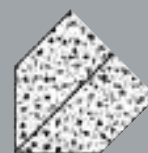

ANGLED



MULTI-ANGLED

Single Point Tools

Our Norton line of single point tools is used in straight and simple form dressing applications. It includes: resettable and non-resettable products, tools for all abrasive types (conventional and advanced ceramic grains) and the technology-leading Norton "Indexable" tool design.

WHEEL FORMS DRESSED BY THESE TOOLS



STRAIGHT



TAPERED



CONVEX



SPECcheck

SELECTION GUIDE

Stock Tools for Ceramic Abrasive Wheels

SG/Ceramic Engineered for use on ceramic (SG, NQ, Targa, etc.) wheels but may also provide significant benefits when used on conventional abrasive products. These tools are furnished with top quality specially selected diamonds.

BCSG/Ceramic Economical alternative to an "SG" tool. Best choice when a disposable tool is preferred.

Stock Tools for Conventional Abrasive Wheels

NS Engineered for use on conventional abrasives. These high quality, value-priced tools can be used for a variety of dressing applications.

BC Economical alternative to an "NS" tool. Best choice when a disposable tool is preferred.

SELECTING THE CORRECT SINGLE POINT TOOL:

- Identify the wheel abrasive type: aluminum oxide, silicon carbide, or ceramic
- Determine the wheel diameter – to select the optimum carat weight
- Determine the tool holder size – to select appropriate shank diameter

EXAMPLES OF SINGLE POINT TOOL SELECTION

Conventional Wheel Spec: 32A46-IVBE 7" x 1/2" x 1-1/4"

Machine has a 7/16" tool holder

Tool Selections:

Resettable: NS2M7 or NSUD2 (Indexable)

Non-Resettable: BC2M7 or BCU2 (Indexable)

Ceramic Wheel Spec:

5SG60-JVS or 5NQ60-IVS 10" x 1" x 3"

Machine has a 3/8" tool holder

Tool Selections:

Resettable: SG3M6

Non-Resettable: BCSG3M6

TECHtip

- Rigidly mount single point tools at a 10° - 15° angle to the wheel centerline with a line drawn through the center of the wheel, pointing in the direction of wheel travel.
- Point of contact should be slightly below centerline of wheel as shown.
- Use coolant whenever possible.
- Normal infeed is .001" per pass.
- Lead selections range from .002" - .010" per wheel revolution.
- Rotate the tool 1/4 turn periodically to maintain a sharp point.

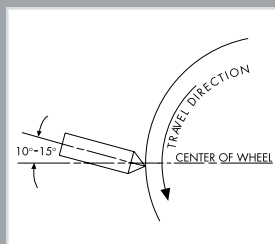

To optimize applications using ceramic abrasives and/or tools, normal dressing parameters must change. Reduce infeed by 25%. Significant reductions in the amount of infeed and frequency of dress will result in substantially lower cost per part ground.

SINGLE POINT DRESS TRAVERSE RATE

Select a Lead Value based on desired Surface Finish and run the formula below.

FINISH	LEAD VALUE (PER WHEEL REVOLUTIONS)
For Coarse Finish (approx. 64 RMS)	.008" to .010"
For Medium Finish (approx. 32 RMS)	.005" to .009"
For Fine Finish (approx. 16 RMS)	.002" to .004"

LEAD VALUE X WHEEL SPEED (RPM) = TRAVERSE RATE IN INCHES/MINUTE

- Slower traverse rates result in a closed wheel face and lower surface finish readings on the workpiece.
- Faster traverse rates result in an open wheel face that produces greater stock removal and a rougher workpiece finish.



It is the user's responsibility to refer to and comply with ANSI B7.1

Single Point Tools CONTINUED



Single Point Tools for Truing/Dressing Ceramic Abrasives

SG/CERAMIC SINGLE POINT TOOLS

FEATURES	BENEFITS
<ul style="list-style-type: none"> ■ Specially selected broad-shaped, diamond ■ Each diamond is hand selected for stone shape, quality and structural integrity ■ Multi-purpose 	<ul style="list-style-type: none"> ■ Withstands the increased grinding pressures of ceramic abrasives ■ Consistent tool performance ■ Accommodate most straight dressing and simple form dressing applications ■ Stand up to ceramic (Norton SG, NQ, TG, etc.) abrasive sharpness; can also be used to dress conventional abrasives

RESETTABLE SG/CERAMIC SINGLE POINT TOOLS

FEATURES AND BENEFITS

- Norton high quality diamond and a proactive resetting program will result in the lowest dressing cost per part

NON-RESETTABLE BCSG/CERAMIC SINGLE POINT TOOLS

FEATURES AND BENEFITS

- The best selection when a resetting program is not feasible or low initial cost is the primary purchasing consideration

WHEEL DIAMETER	TOOL CARAT WEIGHT	TOOL DIAMETER	TOOL LENGTH	BEST		GOOD	
				PRODUCT #	3 SETTABLE PTS (2 RESETS) PART #	PRODUCT #	NON-RESETTABLE PART #
Stock Single Point Tools for Truing/Dressing Ceramic Abrasives							
Up to 7"	1/4 (.25)	3/8"	2"	SG2M6	66260195365	BCSG2M6	66260157007
		7/16"	2"	SG2M7	66260195366	BCSG2M7	66260156905
8" to 10"	1/3 (.33)	3/8"	2"	SG3M6	66260195367	BCSG3M6	66260157008
		7/16"	2"	SG3M7	66260195368	BCSG3M7	66260156906
11" to 14"	1/2 (.50)	3/8"	2"	SG5M6	66260195369	BCSG5M6	66260157009
		7/16"	2"	SG5M7	66260195370	CSG5M7	66260156907
15" to 20"	3/4 (.75)	3/8"	2"	SG7M6	66260195371	BCSG7M	66260156908
		7/16"	2"	SG7M7	66260195372		
21"+	1 (1.00)	7/16"	2"			BCSG10M7	66260157010

STANDARD PACKAGE = 1 TOOL

WHEEL FORMS DRESSED BY THESE TOOLS

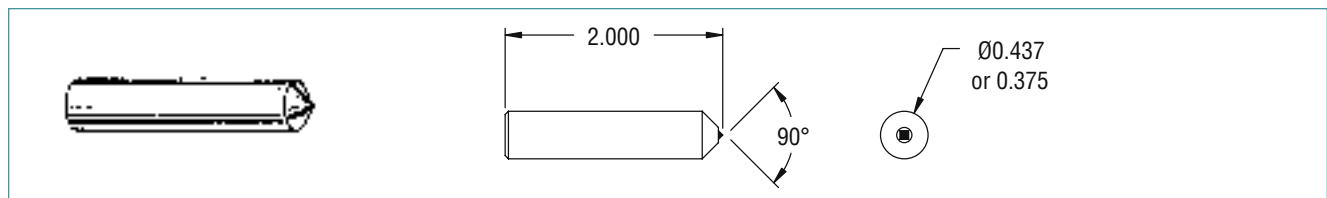
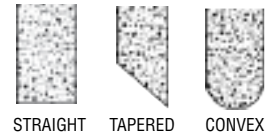

TECHtip

STOCK SINGLE POINT TOOL MARKING SYSTEM

DIAMOND QUALITY	DIAMOND SIZE	SHANK DESIGN	SHANK DIAMETER
SG/Ceramic	1 = 1/5 (.20) carat	M	6 = 3/8"
BCSG/Ceramic	2 = 1/4 (.25) carat	J	7 = 7/16"
NS	3 = 1/3 (.33) carat		
BC	5 = 1/2 (.50) carat		
	7 = 3/4 (.75) carat		
	10 = 1 carat		

EXAMPLE: NS 2 M 6

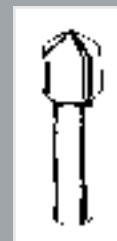

SHANK J



SHANK M

Single Point Tools CONTINUED



Single Point Tools for Truing/Dressing Conventional Abrasives

CONVENTIONAL SINGLE POINT TOOLS

FEATURES

- Consistent diamond structure and shape
- Well defined, sharp diamond point
- Steeper 60 degree included angle head design

BENEFITS

- Repeatable dressing performance
- Durable; maximum cost effectiveness for dressing conventional abrasives
- Greater machine and part clearance produce forms with tighter tolerances

RESETTABLE NS (NORTON STANDARD) SINGLE POINT TOOLS

FEATURES AND BENEFITS

- High quality diamonds, value priced
- Selection of the correct tool and a proactive resetting program will result in the lowest dressing cost per part

NON-RESETTABLE BC SINGLE POINT TOOLS

FEATURES AND BENEFITS

- The best selection when a resetting program is not feasible or low initial cost is the primary purchasing consideration

WHEEL DIAMETER	TOOL CARAT WEIGHT	TOOL DIAMETER	BETTER		GOOD	
			PRODUCT #	2 SETTABLE PTS (1 RESET) PART #	PRODUCT #	NON RESETTABLE PART #
Stock Single Point Tools for Truing/Dressing Conventional Abrasives						
Internal Wheel	1/5 (.20)	3/8"			BC1M6	66260195021
		7/16"			BC1M7	66260195022
Up to 7"	1/4 (.25)	3/8"	NS2M6	66260195116	BC2M6	66260195000
		7/16"	NS2M7	66260195117	BC2M7	66260195001
8" to 10"	1/3 (.33)	3/8"	NS3M6	66260195121	BC3M6	66260195002
		7/16"	NS3M7	66260195122	BC3M7	66260195003
11" to 14"	1/2 (.50)	3/8"	NS5M6	66260195126	BC5M6	66260195004
		7/16"	NS5M7	66260195127	BC5M7	66260195005
15" to 20"	3/4 (.75)	7/16"	NS7M7	66260195132	BC7M6	66260195006
		7/16"	NS7J7	66260195130	BC7M7	66260195007
21" +	1 (1.00)	3/8"	NS10M6	66260195136	BC10M6	66260195008
		7/16"	NS10M7	66260195137	BC10M7	66260195009
		7/16"	NS10J7 *	66260195135		

* J-SHANK TOOLS ARE AVAILABLE IN 7/16" DIAMETER WITH 5/8" HEAD
STANDARD PACKAGE = ONE TOOL

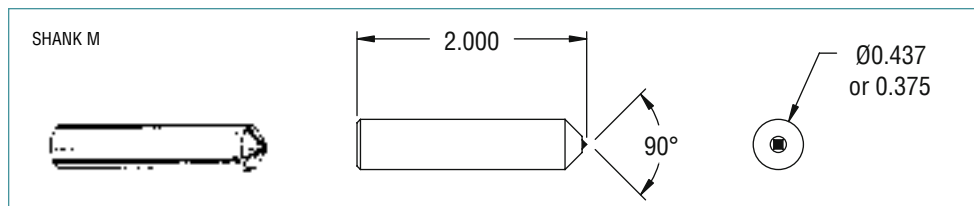
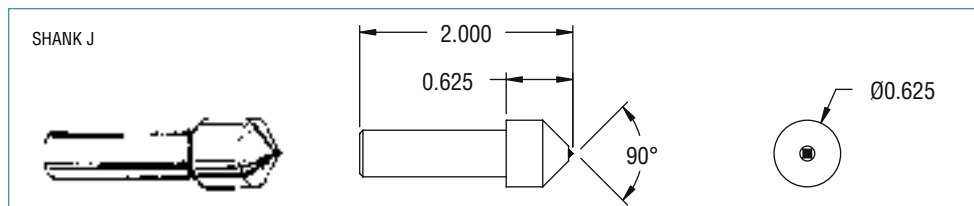
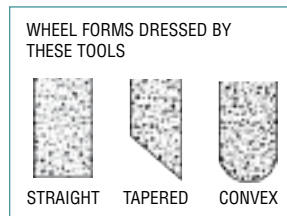

Refer to our Diamond and cBN Superabrasive Standard Product Catalog #8068 sections on www.nortonindustrial.com or your Norton representative for more in-depth information on all Norton superabrasive stock and made-to-order products.

Single Point Tools CONTINUED

Indexable Single Point Tools

Indexable tools are specifically designed to alleviate any misalignment issues and are the tools of choice for CNC grinders. They feature a two-part construction with the head and shank as separate pieces. After the initial installation, operators simply turn the indexable head with a wrench, while the tool shank remains secure (and aligned) in the tool holder.



INDEXABLE SINGLE POINT TOOLS

FEATURES

- Easily turned without removing tool from the holder
- U-Dex-It and Mini-Dex tools have a 60° included angle head design

BENEFITS

- Easier for operators to turn than conventional tools – increasing frequency of beneficial tool turning
- Extended life; less downtime and increased productivity
- Provides additional form versatility through better machine and part clearance
- Excellent choice for regulating wheels

Indexable Single Point Tools for Truing/Dressing Ceramic Abrasives

NON-RESETTABLE BCSGUD/CERAMIC U-DEX-IT INDEXABLE SINGLE POINT TOOLS

FEATURES AND BENEFITS

- These U-Dex-It tools contain specially selected diamonds to withstand increased ceramic (SG, Quantum NQ, Targa TG, etc.) grinding pressures
- Ideal for centerless grinders; using standard 5/8" wrench, the head can be turned through the hole in the side of the wheel guard without removing the guard
- The best selection when a resetting program is not feasible or low initial cost is the primary purchasing consideration

WHEEL DIAMETER	TOOL CARAT WEIGHT	TOOL SIZE	GOOD	
			PRODUCT #	NON-RESETTABLE PART #
Stock Indexable Single Point Tools for Truing/Dressing Ceramic Abrasives				
Up to 7"	1/4 (.25)	7/16" x 1-7/16" with 5/8" head	BCSGUD2	66260162669
11" to 14"	1/2 (.50)	7/16" x 1-7/16" with 5/8" head	BCSGUD5	66260159894
STANDARD PACKAGE = ONE TOOL				

WHEEL FORMS DRESSED BY THESE TOOLS

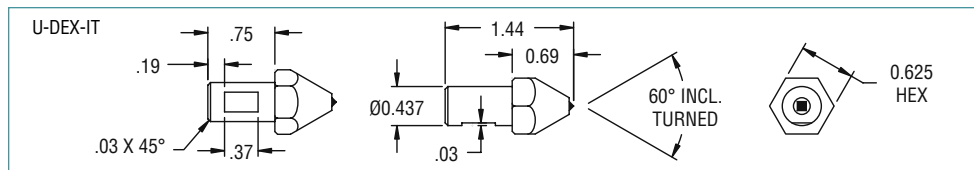
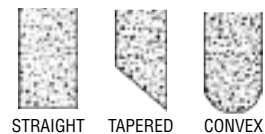

Indexable Single Point Tools for Truing/Dressing Conventional Abrasives

RESETTABLE NORTON STANDARD NSUD U-DEX-IT INDEXABLE SINGLE POINT TOOLS

FEATURES AND BENEFITS

- High quality diamonds, value priced
- Ideal for centerless grinders; using standard 5/8" wrench, the head can be turned through the hole in the side of the wheel guard without removing the guard
- Selection of the correct tool and a proactive resetting program will usually result in the lowest dressing cost per part

RESETTABLE NORTON STANDARD NSMD MINI-DEX INDEXABLE SINGLE POINT TOOLS

FEATURES AND BENEFITS

- High quality diamonds, value priced
- Use a standard 7/16" wrench to turn; designed for internal, bearing race, and twist drill flute machines
- Selection of the correct tool and a proactive resetting program will usually result in the lowest dressing cost per part

NON-RESETTABLE BCUD U-DEX-IT INDEXABLE SINGLE POINT TOOLS

FEATURES AND BENEFITS

- Ideal for centerless grinders; using standard 5/8" wrench, the head can be turned through the hole in the side of the wheel guard without removing the guard
- The best selection when a resetting program is not feasible or low initial cost is the primary purchasing consideration

Single Point Tools CONTINUED

Indexable Single Point Tools for Truing/Dressing Conventional Abrasives CONTINUED

WHEEL DIAMETER	TOOL CARAT WEIGHT	TOOL SIZE	PRODUCT #	BETTER	GOOD
				2 SETTABLE PTS (1 RESET) PART #	PRODUCT # NON-RESETTABLE PART #
Stock Indexable Single Point Tools for Truing/Dressing Conventional Abrasives					
Up to 7"	1/4 (.25)	7/16" x 1-7/16" with 5/8" head 1/4" x 1-3/16" with 7/16" head	NSMD2	66260195171	BCUD2 66260195023
8" to 10"	1/3 (.33)	7/16" x 1-7/16" with 5/8" head	NSUD3	66260195162	BCUD3 66260195024
		1/4" x 1-3/16" with 7/16" head	NSMD3	66260195172	
11" to 14"	1/2 (.50)	7/16" x 1-7/16" with 5/8" head	NSUD5	66260195163	BCUD5 66260195025
15" to 20"	3/4 (.75)	7/16" x 1-7/16" with 5/8" head	NSUD7	66260195164	

STANDARD PACKAGE = ONE TOOL

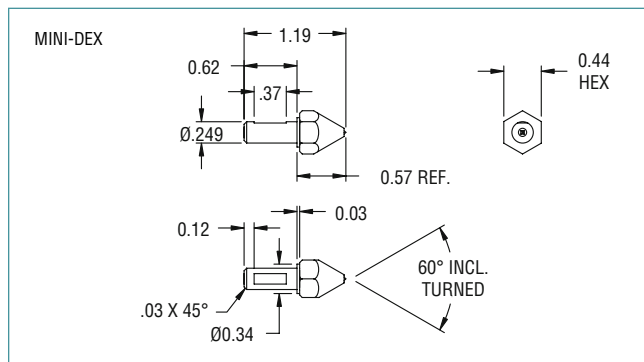
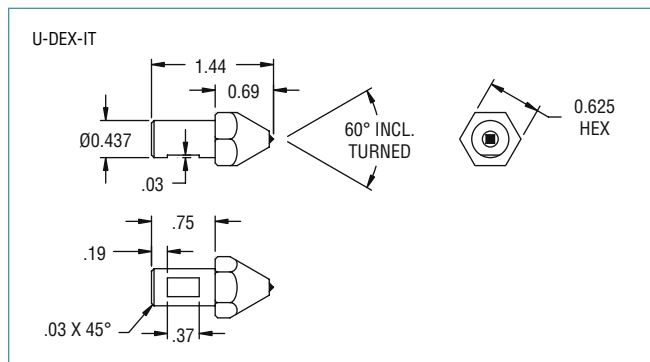

Internal Grinding Tools



RESETTABLE INTERNAL GRINDING TOOLS

FEATURES AND BENEFITS

- Q style shank is used on a Heald internal grinder (resettable)

MACHINE TYPE	CARAT WEIGHT	SHANK DIAMETER	TOOL LENGTH	PRODUCT #	BEST
					2 SETTABLE PTS (1 RESET) PART #
Stock Internal Grinding Tools					
Heald	1/5 (.20)	7/16"	1"	NI21Q7	66260195180

STANDARD PACKAGE = 1 TOOL

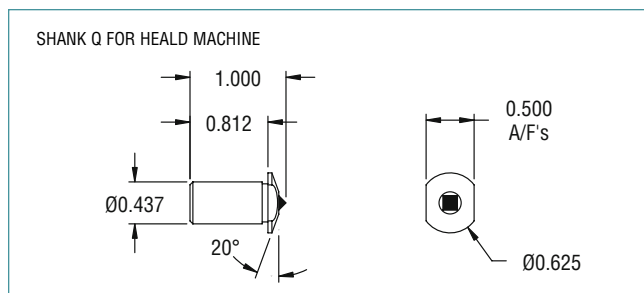
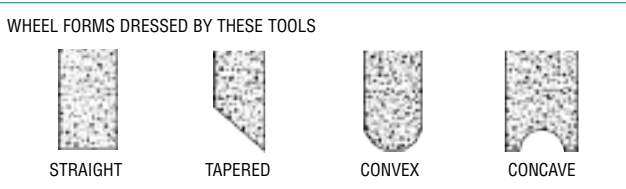

Single Point Tools CONTINUED

Thread Grinding Tools



RESETTABLE SG/CERAMIC THREAD GRINDING TOOLS

FEATURES AND BENEFITS

- These wheels are used on J & L and Excello thread grinding machines to accurately dress the grinding wheels that form the desired thread configuration (non-resettable)

MACHINE TYPE	SHANK DIAMETER	TOOL LENGTH	INCLUDED ANGLE	MAX. RADIUS ON POINT	BEST	
					PRODUCT #	NON-RESETTABLE PART #
Stock Thread Grinding Tools						
J & L	1/4"	1"			38RL4*	66260195100
J & L	1/4"	1"	80°	.010"	NT1L4	66260195187
EXCELLO	3/8"	1-5/8"	60°	.010"	NT106	66260195190

* 38RL4 IS A MULTI-POINT (GRIT) 30 - 40 MESH TOOL
STANDARD PACKAGE = 1 TOOL

WHEEL FORMS DRESSED BY THESE TOOLS



STRAIGHT



TAPERED

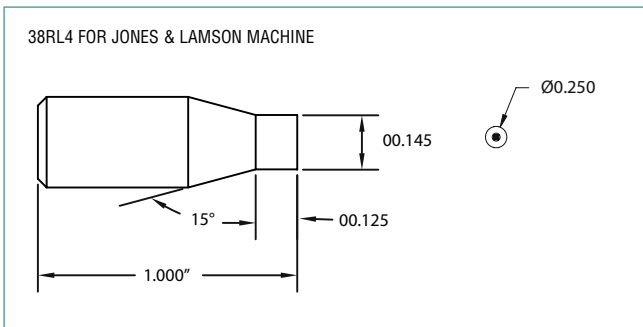
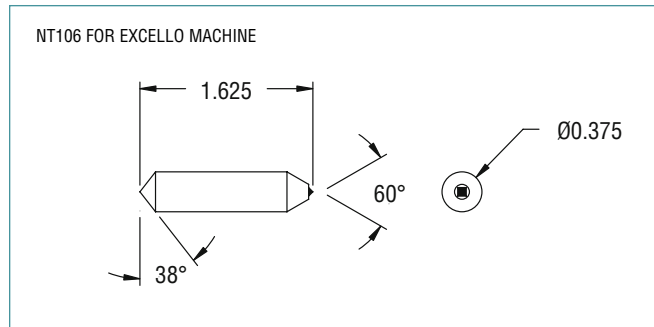
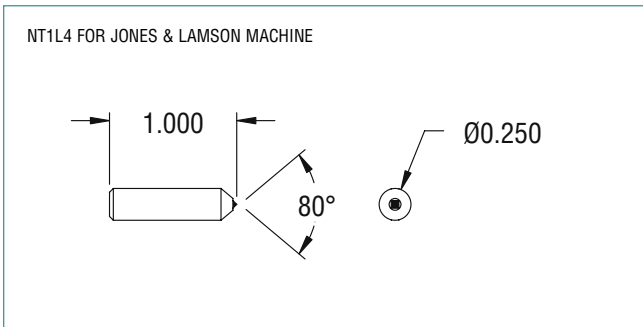

Refer to our Diamond and cBN Superabrasive Standard Product Catalog #8068 sections on www.nortonindustrial.com or your Norton representative for more in-depth information on all Norton superabrasive stock and made-to-order products.



Toolroom Tools

Norton Toolroom Dressing Tools are primarily used on surface grinders to form the grinding wheel to an exact concave or convex radius. Although some tools are designed for use on a specific machine, many radius tools can be used on any grinder having the correct set-up.

Used generally on 8" diameter and smaller vitrified toolroom wheels, Norton offers a selection of phono-point, conventional radius, and full ball radius tools.

WHEEL FORMS DRESSED BY THESE TOOLS



Phono-Point Tools

For general toolroom concave and convex dressing on small diameter grinding wheels. Not resettable.

INCLUDED ANGLE	SHANK DIAMETER	TOOL LENGTH	BETTER		GOOD	
			PRODUCT #	NON-RESETTABLE PART #	PRODUCT #	NON-RESETTABLE PART #
Stock Phono-Point Tools						
60°	1/8"	1"	NP1M2	66260195225	BCPP-60	66260195017
	3/16"	1"	NP1M3	66260195226		
	1/4"	1"	NP1M4	66260195227		
75°	1/8"	1"	NP2M2	66260195228	BCPP-75	66260195018
	1/4"	1"	NP2M4	66260195230		
90°	1/8"	1"	NP3M2	66260195231	BCPP-90	66260195019
	3/16"	1"	NP3M3	66260195232		
	1/4"	1"	NP3M4	66260195233		

STANDARD PACKAGE = ONE TOOL

WHEEL FORMS DRESSED BY THESE TOOLS

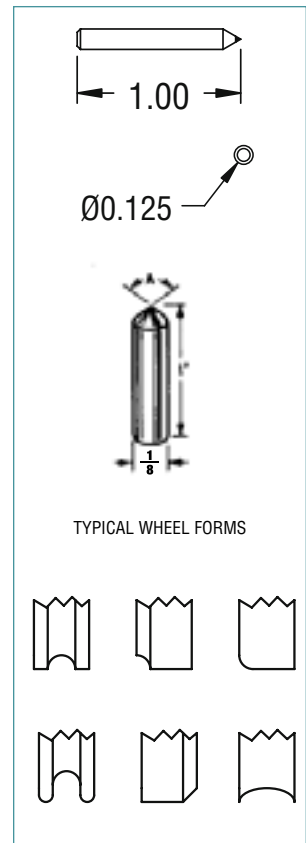

TECHtip

HOW TO USE TOOLROOM TOOLS

- We recommend dressing with coolant. However, if dressing totally dry, allow three to five seconds between passes for diamond to cool.
- Use extremely light cuts from .0002" to .001" maximum.
- Rotate tool if the application and set-up allow.
- Full Ball Radius Tools should be returned for relap after minimum wear.

SPECcheck

PHONO-POINT TOOL MARKING SYSTEM

TOOL TYPE	INCLUDED ANGLE ON DIAMOND	SHANK STYLE	SHANK DIAMETER
NP	1 = 60°	M	2 = 1/8"
BCPP	2 = 75°		3 = 3/16"
	3 = 90°		4 = 1/4"

Example: NP 1 M 3

Toolroom Tools CONTINUED

Radius Tools

Concave Radius Tools

This line offers a specially-shaped single point diamond, designed for forming concave radii on small diameter grinding wheels. Not resettable.

Convex Radius Tools

This line offers a specially-shaped single point diamond, designed for forming convex radii on small diameter grinding wheels. Not resettable.

Half-Circle Concave Radius Tools (Available as Non-stock Only)

This line offers a specially-shaped diamond set in the side of the shank for forming half-circle radii on small diameter grinding wheels. The tool is rotated to form the radius. Commonly called a "rat tail dresser." Not resettable.

RADIUS SIZE TO BE DRESSED	SHANK DIAMETER	TOOL LENGTH	BEST		GOOD	
			PRODUCT #	NON-RESETTABLE PART #	PRODUCT #	NON-RESETTABLE PART #
Stock Concave Radius Tools						
.010" to .015"	3/8"	2"	NR1P6	66260195210		
.016" to .020"	3/8"	2"	NR2P6	66260195211		
.021" to .032"	3/8"	2"	NR3P6	66260195212		
.033" to .062"	3/8"	2"	NR4P6	66260195213	BCRD	66260195016
.063" to .125"	3/8"	2"	NR5P6	66260195214	BCRD	66260195016
.126" to .250"	3/8"	2"	NR6P6	66260195215	BCRD	66260195016
Stock Convex Radius Tools						
.020" to .125"	3/8"	2"	NR2M6	66260195216		
.126" to .250"	3/8"	2"	NR12M6	66260195217		
.251" to .500"	3/8"	2"	NR25M6	66260195218		

STANDARD PACKAGE = ONE TOOL

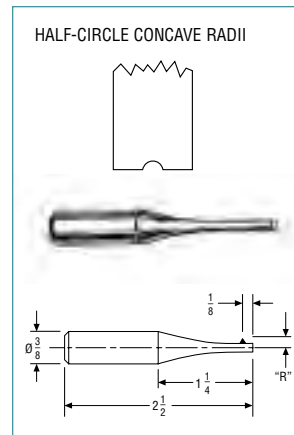
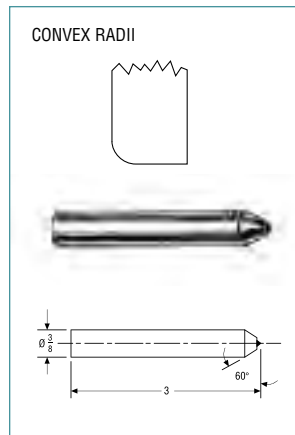
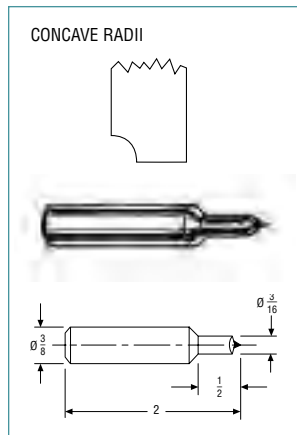

Full-Ball Radius Tools for precision plunge form dressing of concave radii in the center of a grinding wheel are available made to your custom requirements. Ask your Norton representative for details.

Refer to our Diamond and cBN Superabrasive Standard Product Catalog #8068 sections on www.nortonindustrial.com or your Norton representative for more in-depth information on all Norton superabrasive stock and made-to-order products.



Multi-Point (Grit) Tools

Since Norton conventional and high-performance Multi-Point tools never need turning or resetting, they are the most economical way to accomplish a variety of straight, tapered, and step dressing operations on all sizes of cylindrical, centerless, surface, and toolroom grinding wheel applications.

WHEEL FORMS DRESSED BY THESE TOOLS



STRAIGHT



TAPERED

NORTON MULTI-POINT TOOLS

FEATURES

- Uniformly distributed diamonds in a tough, durable matrix
- Fresh, multiple diamond points exposed in truing operation; no turning or resetting required
- Overall diamond weight exceeds equivalent single point tool

BENEFITS

- Consistent performance throughout tool life
- Faster, more consistent straight face dressing with maximum efficiency and longer tool life than single point tools
- The most economical way to dress straight and tapered forms

TECHtip

MULTI-POINT TOOLS – STRAIGHT FACE DRESSING AND TRUING

- Most multi-point tools are used for straight face dressing.
- Tool should have full face contact with the wheel.
- With new tool, 3–5 passes at .005" per pass should be taken to expose diamonds.
- Infeed per pass .001" - .002"
- Use coolant whenever possible.
- Use appropriate lead (and traverse rate).
- Contact your Norton representative for proper tool selection for Targa wheels.

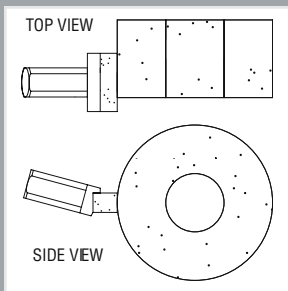

MULTI-POINT DRESS TRAVERSE RATE

Select a Lead Value based on desired Surface Finish and run the formula below.

FINISH	LEAD VALUE (PER WHEEL REVOLUTIONS)
For Coarse Finish (approx. 64 RMS)	.023" to .030" (.58mm – .76mm)
For Medium Finish (approx. 32 RMS)	.013" to .022" (.33mm – .57mm)
For Fine Finish (approx. 16 RMS)	.006" to .012" (.15mm – .33mm)

LEAD VALUE X WHEEL SPEED (RPM) = TRAVERSE RATE IN INCHES/MINUTE

- Slower traverse rates result in a closed wheel face that produces less stock removal and improved workpiece finish.
- Faster traverse rates result in an open wheel face that produces greater stock removal and a rougher workpiece finish.



It is the user's responsibility to refer to and comply with ANSI B7.1

SPECcheck

SELECTING THE CORRECT MULTI-POINT TOOL

- Identify the wheel abrasive type: ceramic (Norton SG, Quantum NQ, Targa TG), aluminum oxide, or silicon carbide
- Determine the wheel diameter and grit size
- Determine the tool's approach angle to the centerline of the wheel
- Identify the tool holder diameter
- Use 1E shape for angular wheel slide, cylindrical grinding and for shoulder or step truing

EXAMPLES OF MULTI-POINT TOOL SELECTION

- Conventional Wheel Spec:** 32A46-IVBE 7" x 1/2" x 1-1/4"
Machine has a 3/8" tool holder
- Tool Selection:** 1R6J6
- Ceramic Wheel Spec:** 5SG60-JVS or 5NQ60-IVS 10" x 1" x 3"
Machine has a 7/16" tool holder
- Tool Selections:** SG1R6J7

Multi-Point (Grit) Tools CONTINUED

SPECcheck



MULTI-POINT TOOL DIAMOND SECTION SPECIFICATIONS

SHAPE	WIDTH	LENGTH	DEPTH	TOOL APPROACH ANGLE TO WHEEL	FOR WHEEL DIAMETER
1A	1/4"	3/4"	5/16"	0°	Over 20"
2A	1/4"	1/2"	3/8"	0°	15" – 20"
3A	5/32"	3/8"	1/4"	0°	Over 20"
1E	5/32"	3/8"	5/16"	–	
2E	1/4"	1/2"	1/2"	–	20" x 2" and up
1R	1/4" Round		1/4"	0°	Up to 10"
2R	3/8" Round		3/8"	0°	11" – 14"



A SHAPE IS USED PRIMARILY FOR STRAIGHT FACE DRESSING.

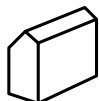

E SHAPE (DOUBLE ANGLE TOP FACE) IS USED FOR STANDARD N-FACE WHEELS, ANGULAR WHEELS, FACE AND SIDE TRUING OF CYLINDRICAL WHEELS, AND IN STEP DRESSING.



R SHAPE IS USED FOR STRAIGHT FACE DRESSING WHERE THE TOOL HOLDER IS PERPENDICULAR TO THE WHEEL FACE (NO DRAG ANGLE), AND ON THREAD GRINDING MACHINES.

MULTI-POINT TOOL MARKING SYSTEM

DIAMOND SHAPE	TOOL DIAMOND SIZE	TO DRESS GRINDING WHEELS WITH GRIT SIZE OF:	SHANK DESIGN	SHANK DIAMETER
1A	4	= 46 grit	See the following pages for shank configurations	6 = 3/8"
2A	6	= 54 - 100 grit		7 = 7/16"
3A	8	= 120 - 150 grit		8 = 1/2"
1E	12	= 150+ grit		
2E	14	= Special Applications		
1R				
2R				

Example: 1A 6 A 7

Multi-Point Tools for Straight Dressing

SG MULTI-POINT TOOL SHAPE AND SHANK AVAILABILITY

SHAPE SG1A SHANK A



SHAPE SG1A SHANK C



SHAPE SG2A SHANK D



SHAPE SG2A SHANK E



SHAPE SG1R SHANK J



SHAPE SG2R SHANK K



CONVENTIONAL TOOLROOM MULTI-POINT TOOL SHAPE AND SHANK AVAILABILITY

SHAPE 1A BC-60



SHAPE 1A BC-61



SHAPE 2A BC-62



SHAPE 2A BC-63



SHAPE 1R BC-64



SHAPE 1R BC-65



CONVENTIONAL ABRASIVE MULTI-POINT TOOL SHAPE AND SHANK AVAILABILITY

SHAPE 1A SHANK A



SHAPE 1A SHANK B



SHAPE 1A SHANK C



SHAPE 2A SHANK D



SHAPE 2A SHANK E



SHAPE 3A SHANK F



SHAPE 3A SHANK G



SHAPE 1E SHANK F



SHAPE 1R SHANK J



SHAPE 2R SHANK K



SHAPE 3R SHANK L



SHAPES 3A (F AND G SHANKS) ARE USED FOR FORM, SHAPE, AND STEP TRUING. SHAPE 1E IS USED FOR ANGLE DRESSING

TECHtip

OPTIMIZING SG MULTI-POINT TOOL PERFORMANCE

- To optimize applications using ceramic abrasives/tools, normal dressing parameters must change. Significant reductions in the amount of infeed and frequency of dress will result in significantly lower cost per part ground.
- While all Norton SG/Ceramic tools have been designed to improve the efficiency of ceramic grinding applications, they can also offer significant benefits in many applications using conventional abrasives.
- When first using a Norton SG/Ceramic tool, make 3 to 5 passes at .005" infeed to ensure full face contact between the dressing tool and wheel face.
- Reduce normal dressing infeed by half. Do not exceed infeed of .002" per pass.
- The lead selection should be between .006"-.030" per wheel revolution. Faster traverse with a Norton SG/Ceramic tool generally provides an open wheel face that can maximize productivity of the ceramic abrasive.

Multi-Point (Grit) Tools CONTINUED

Multi-Point Tools for Truing and Straight Dressing

SG/CERAMIC MULTI-POINT TOOLS

FEATURES AND BENEFITS

- Designed specifically for use on ceramic (Norton SG, Quantum NQ, Targa TG, etc.) abrasives, SG tools contain a higher diamond concentration to withstand the increased grinding pressures generated by the ceramic abrasives. These tools have improved life and dress quality; they can also offer significant benefits in many applications using conventional abrasives.

STANDARD MULTI-POINT TOOLS

FEATURES AND BENEFITS

- The ideal selection for use on conventional abrasives in high-production applications

BC MULTI-POINT TOOLS

FEATURES AND BENEFITS

- These general-purpose tools are the ideal selection for conventional toolroom applications
- BC multi-point tools contain a specially selected diamond size for a broad range of dressing applications

WHEEL FORMS DRESSED BY THESE TOOLS



STRAIGHT

TIER:
TO DRESS:

BEST	BETTER	GOOD
Ceramic Abrasives	Conventional Abrasives	Conventional Toolroom

WHEEL DIAMETER	WHEEL GRIT SIZE	TOOL APPROACH ANGLE	TOOL DIAMETER	PRODUCT #	PART #	PRODUCT #	PART #	PRODUCT #	PART #				
Multi-Point Tools for Straight Dressing													
Up to 10"	54 to 100	0°	7/16"	SG1R6J7	66260195377	1R6J7	66260195088	BC64	66260195014				
		0°	3/8"			1R6J6	66260195085						
11" to 14"	54 to 100	0°	7/16"	SG2R6K7	66260195378	2R6K7	66260195096	BC65	66260195015				
		0°	7/16"			2A4D7	66260195045						
15" to 20"	46	0°	7/16"			2A4E7	66260195048						
		15°	7/16"			1B4C7	66260195060						
		15°	7/16"										
		0°	7/16"			SG2A6D7	66260195375			2A6D7	66260195046	BC62	66260195012
		15°	7/16"			SG2A6E7	66260195376			2A6E7	66260195049	BC63	66260195013
		0°	7/16"							2A8D7	66260195047		
21" +	46	0°	7/16"			2A8E7	66260195050						
		15°	7/16"			1A4A7	66260195030						
		15°	7/16"			1A4C7	66260195038						
		0°	7/16"			SG1A6A7	66260195373			1A6A7	66260195031	BC61	66260195011
		15°	7/16"							1A6B7	66260195035		
		15°	7/16"			SG1A6C7	66260195374			1A6C7	66260195039	BC60	66260195010
120 to 150	15°	7/16"			1A8C7	66260195040							

STANDARD PACKAGE = ONE TOOL

Multi-Point Tools for Form, Shape, or Step Dressing Conventional Abrasives

WHEEL DIAMETER	WHEEL GRIT SIZE	TOOL APPROACH ANGLE	TOOL DIAMETER	BETTER	
				PRODUCT #	PART #
Stock Multi-Point Tools for Form, Shape, and Step Dressing					
All	54 to 100	0°	7/16"	3A6F7	66260195055
		15°	7/16"	3A6G7	66260195975
		120 to 150	15°	7/16"	3A8G7

STANDARD PACKAGE = ONE TOOL

WHEEL FORMS DRESSED BY THESE TOOLS



STRAIGHT



TAPERED

WHEEL DIAMETER	WHEEL GRIT SIZE	TOOL APPROACH ANGLE	TOOL DIAMETER	BETTER	
				PRODUCT #	PART #
Stock Multi-Point Tools for Angular Dressing Conventional Abrasives					
All	54 to 100	0°	7/16"	1E6F7	66260195080

STANDARD PACKAGE = ONE TOOL

WHEEL FORMS DRESSED BY THESE TOOLS



TAPERED

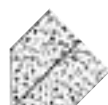

ANGLED

High Performance Grit Tools

Norton High Performance grit tools are used in the same manner as multi-point tools, but are designed to produce a superior finish. They are used on 120 - 150 grit wheels. The traverse rates are equal to or faster than ordinary tools. Mounted on standard shanks, standard High Performance grit tools have a 3/8" wide by .100" thick diamond impregnated blade with a greater number of sharp points than in ordinary multi-point tools.

Since High Performance grit tools contain a higher concentration of diamond than found in standard multi-point tools, they are well suited for ceramic abrasive applications.

Typical Machines and Applications

- HP4439: cylindrical machines, grinding thrust walls, bearing diameters and multi-diameter shafts with radii
- HP4511: angular machines plunge grinding multi-diameter shafts and plunge grinding on dual-wheel forms
- HP4595: cylindrical machines grinding main bearing and lobes on camshafts
- HP4596: centerless machines step grinding and machines dual-wheel grinding transmission shafts

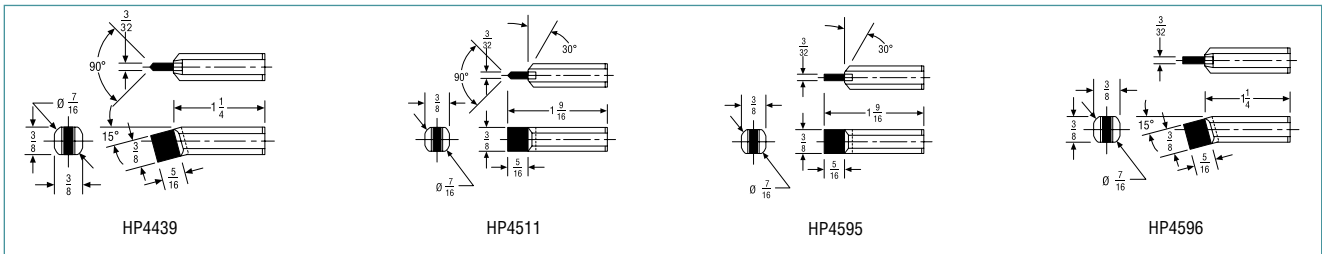

WHEEL DIAMETER	WHEEL GRIT SIZE	SHANK DIAMETER	TOOL LENGTH	BEST	
				PRODUCT #	PART #
Stock High Performance Grit Tools					
Up to 20"	120 to 150	7/16"	1-9/16"	HP4439	66260195270
Up to 20"	120 to 150	7/16"	1-9/16"	HP4511	66260195271
Up to 20"	120 to 150	7/16"	1-9/16"	HP4595	66260195272
Up to 20"	120 to 150	7/16"	1-9/16"	HP4596	66260195273

STANDARD PACKAGE = ONE TOOL

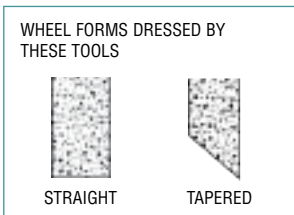

Refer to our **Diamond and cBN Superabrasive Standard Product Catalog #8068** sections on www.nortonindustrial.com or your Norton representative for more in-depth information on all Norton superabrasive stock and made-to-order products.

Blade Tools



With the choice of natural and synthetic diamond in three performance/price tiers, Norton blade tools can meet all your angle, step, and radius dressing requirements for cylindrical, surface, and centerless grinding.

WHEEL FORMS DRESSED BY THESE TOOLS



STRAIGHT



TAPERED

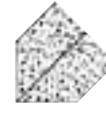

ANGLED



MULTI-ANGLED



SYNTHETIC BLADE TOOLS – USB AND NORTON QUANTUM

FEATURES	BENEFITS
<ul style="list-style-type: none"> ■ USB (made-to-order) 	<ul style="list-style-type: none"> ■ For dressing aluminum oxide wheels
<ul style="list-style-type: none"> ■ NEW! Norton Quantum NQ (stock and made-to-order) 	<ul style="list-style-type: none"> ■ For dressing ceramics and silicon carbide wheels
<ul style="list-style-type: none"> ■ Synthetic diamond with a controlled diamond shape provides a constant cross section of diamond to the wheel throughout the life of the tool 	<ul style="list-style-type: none"> ■ Provides consistent wheel conditioning from the first dress to last ■ Ideal for close tolerance wheel dressing on manual and CNC grinders, long production runs, and critical form and finish applications (e.g. automotive cam, crank, and valve grinding) ■ Economical, long-lasting alternative to chisel-type tools for centerless form grinding

MULTI-CUT BLADE TOOLS (AVAILABLE IN STOCK AND MADE-TO-ORDER)

FEATURES	BENEFITS
<ul style="list-style-type: none"> ■ Manufactured with top quality elongated-shaped natural diamond 	<ul style="list-style-type: none"> ■ The choice when natural diamond is preferred on surface, cylindrical, and centerless grinders ■ Durable performing tools in a medium price range

LONG LIFE BLADE TOOLS (ALL ARE MADE-TO-ORDER)

FEATURES	BENEFITS
<ul style="list-style-type: none"> ■ Manufactured with processed elongated-shaped natural diamond 	<ul style="list-style-type: none"> ■ Developed as the first generation of the blade tool line for surface, cylindrical, and centerless grinders ■ The choice when initial price is the primary purchasing consideration

			BEST		BETTER	
			Norton Quantum Tools		Multi-Cut Tools	
WHEEL DIAMETER (WIDTH <= 9")	TOOL APPROACH ANGLE	SHANK DIAMETER	PRODUCT #	PART #	PRODUCT #	PART #
Stock Blade Tools						
12" to 17"	0°	7/16"	NQ20A7	07958747944		
	15°	7/16"	NQ215A7	07958747945	MC355	66260195266
18" to 29"	0°	7/16"	NQ30A7	07958747946		
	15°	7/16"	NQ315A7	07958747947	MC375	66260195267
30" - 36"	0°	7/16"	NQ50A7	07958747948		
	15°	7/16"	NQ515A7	07958747950		

THESE STOCK TOOLS ARE COMPOSED OF 1 LAYER WITH 3 DIAMONDS. THESE TOOLS ARE NOT RESETTABLE OR RELAPPABLE.

STANDARD PACKAGE = ONE TOOL

WHEEL FORMS DRESSED BY THESE TOOLS

STRAIGHT TAPERED ANGLED MULTI-ANGLED

Form Tools



Norton Form Tools have diamond lapped to specific angles and radii required for a particular application, machine, contour dressing system, or CNC operation. Due to the high degree of accuracy necessary, the diamond is of special shape and quality.

WHEEL FORMS DRESSED BY THESE TOOLS

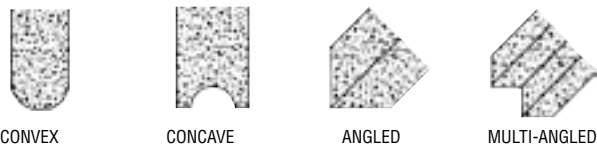

CONE POINT TOOLS

FEATURES AND BENEFITS

- The Norton vacuum braze technology used in the manufacturing surpasses all traditional diamond retention methods.
- Benefits of this technology include absolute diamond retention, diamond pullout prevention during the dressing cycle, and longer tool life through multiple relaps
- Because the diamond is accurately coned to the specific included angle and radius, these tools are ideal when the most intricate, precise forms and radii are required
- Can be relapped

U-Dex-It Cone Point Tool

Used for precision dressing of intricate forms and radii. Specially designed with 5/8" indexable head for easy turning during use. These tools can be relapped.

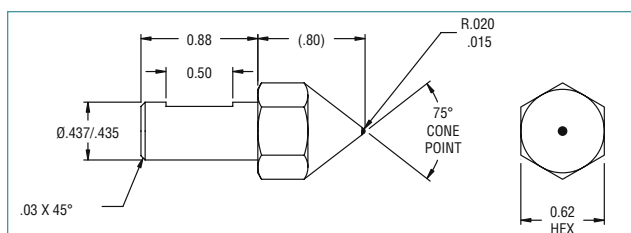

							BEST
INCLUDED ANGLE ON DIAMOND	RADIUS ON DIAMOND	TOOL CARAT WEIGHT	SHANK DIAM.	TOOL LENGTH	PRODUCT #	RELAPPABLE PART #	
Stock U-Dex-It Cone Point Tool							
75°	.020"	.50	7/16"	1.678"	CPUD720-7	66260158981	
STANDARD PACKAGE = ONE TOOL							

WHEEL FORMS DRESSED BY THESE TOOLS

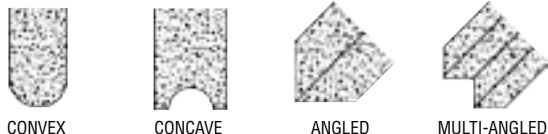

SPECcheck

CONE POINT TOOL MARKING SYSTEM

TOOL TYPE	INCLUDED ANGLE ON DIAMOND	RADIUS ON DIAMOND	CARAT WEIGHT	SHANK DIAMETER
CP	6 = 60°	05 = .005"	L = .10 - .15	6 = 3/8"
	7 = 75°	10 = .010"	M = .20 - .25	7 = 7/16"
	9 = 90°	15 = .015"	H = .33	
		20 = .020"	X = .50	
		25 = .025"		
	30 = .030"			

Example: CP 6 10 M-6

Refer to our Diamond and cBN Superabrasive Standard Product Catalog #8068 sections on www.nortonindustrial.com or ask your Norton representative for information on our made-to-order form tools for the following machines:

- Jones & Lamson
- Moore Pantograph
- Høglund
- Dia-Form

TECHtip

HOW TO USE FORM DRESSING TOOLS

- Proper centerline and light infeeds are essential to minimize side pressure. Excessive pressure will cause the diamond to fracture.
- Cone point tools should be rotated approximately 1/4 turn daily.

Form Tools CONTINUED

Standard Cone Point Tool

These tools are used for precision dressing when the most intricate forms and radii are required. Can be relapped.

BEST						
INCLUDED ANGLE ON DIAMOND	RADIUS ON DIAMOND	TOOL CARAT WEIGHT	SHANK DIAM.	TOOL LENGTH	PRODUCT #	RELAPPABLE PART #
Stock Standard Cone Point Tools						
60°	.010"	.20 - .25	3/8"	2"	CP610M-6	66260195240
STANDARD PACKAGE = ONE TOOL						

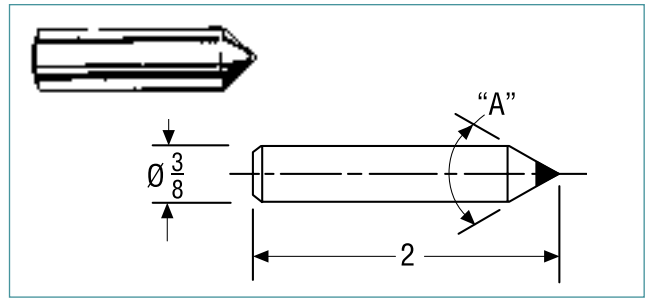

Refer to our Diamond and cBN Superabrasive Standard Product Catalog #8068 sections on www.nortonindustrial.com or your Norton representative for more in-depth information on all Norton superabrasive stock and made-to-order products.

WHEEL FORMS DRESSED BY THESE TOOLS

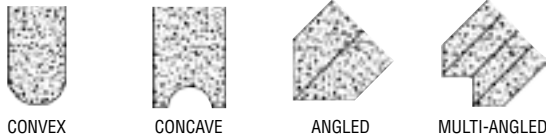

Chisel Point Tool for Toyoda Grinders

High-precision chisel point tool designed for forming intricate shapes and radii. Specifically engineered to fit Toyoda machine series GL32 and GL4, it can also be used on various straight and angle-head grinders – for dressing conventional and ceramic abrasive wheels, sizes 12" to 24". This tool can be reset/relapped.

BEST						
INCLUDED ANGLE ON DIAMOND	RADIUS ON DIAMOND	TOOL CARAT WEIGHT	SHANK DIAM.	TOOL LENGTH	PRODUCT #	RELAPPABLE PART #
Stock Chisel Point Tool						
55°	.020"	.75	7/16"	1.10"	CHT520-7	66260103741
STANDARD PACKAGE = ONE TOOL						

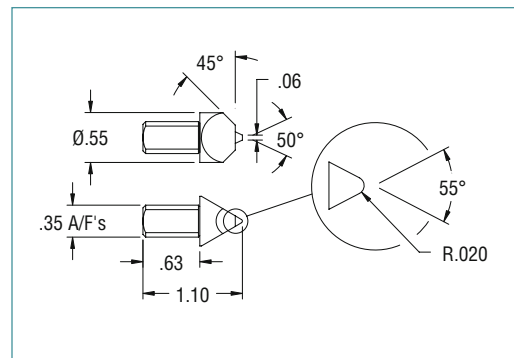

WHEEL FORMS DRESSED BY THESE TOOLS



SPECcheck

CHISEL POINT TOOL MARKING SYSTEM

TOOL TYPE	INCLUDED ANGLE ON DIAMOND	RADIUS ON DIAMOND	CARAT WEIGHT	SHANK DIAMETER
CH =	6 = 60°	05 = .005"	L = .10 - .15	6 = 3/8"
Natural	7 = 75°	10 = .010"	M = .20 - .25	7 = 7/16"
Diamond	9 = 90°	15 = .015"	H = .33	
		20 = .020"	X = .50	
		25 = .025"		
		30 = .030"		

Example: CH 9 5 M-6

TECHtip

CHISEL POINT TOOLS

Chisel Point Tools should be rotated 180° when dulling or contour problems occur.



Cluster Tools

Norton Cluster Tools are designed specifically for straight face dressing of large diameter, coarse grit grinding wheels on single or double disc, centerless, or surface grinders.

WHEEL FORMS DRESSED BY THESE TOOLS



CONVEX



TAPERED

Multi-Point Cluster Tools

Multi-Point Cluster tools are typically used for straight face dressing on disc and centerless operations. For greatest efficiency, these tools should be mounted at a 15° angle so that three diamonds are in contact with the wheel face at all times. The tool should be rotated at frequent intervals. Not resettable.

				BETTER	
DIAMONDS ON FACE	SHANK DIAMETER	TOOL LENGTH	PRODUCT #	NON-RESETTABLE PART #	
Stock Multi-Point Cluster Tools					
7	7/16"	1-5/16"	NC7K7	66260195206	
STANDARD PACKAGE = 1 TOOL					

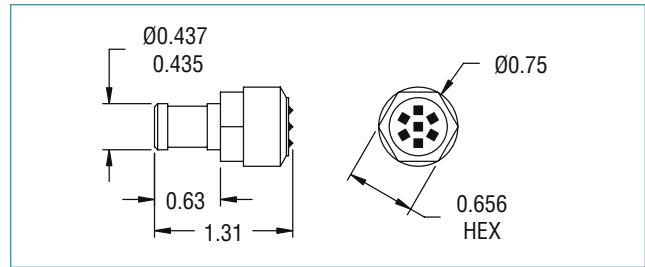

WHEEL FORMS DRESSED BY THESE TOOLS



STRAIGHT



TAPERED

Dia-Pak Tools

Dia-Pak tools are primarily used in straight face disc grinding, but are extremely versatile and may also be used in centerless and surface operations. Designed for maximum economy, three layers of diamond are carefully arranged so that a new layer is exposed before the previous layer is completely worn away. Not resettable.

				BETTER	
FOR WHEEL DIAMETERS	DIAMONDS PER LAYER	SHANK DIAMETER	TOOL LENGTH	PRODUCT #	NON-RESETTABLE PART #
Stock Dia-Pak Tools					
Up to 14"	5-4-5	7/16"	2"	DP20	66260195200
Up to 20"	7-6-7	7/16"	2"	DP30	66260195201
Any	7-6-7	7/16"	2"	DP35	66260195202
STANDARD PACKAGE = 1 TOOL					

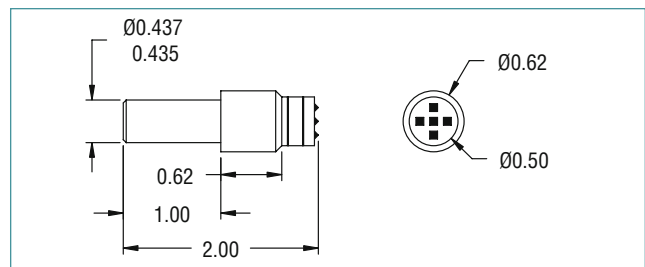

WHEEL FORMS DRESSED BY THESE TOOLS



STRAIGHT



TAPERED

TECHtip

CLUSTER AND DIA-PAK TOOLS – STRAIGHT FACE DRESSING OF HARD / COARSE WHEELS:

Tool should approach the wheel at a 15° angle and be rotated periodically to keep three diamonds in contact with the wheel at all times.

Tools can also be used at a 90° to the wheel face.

Multi-Point Cluster Tools should be rotated at frequent intervals.

Infeed per pass should not exceed .0015" (.001" with ceramic – Norton SG, Quantum, Targa TG, etc. – wheels).

Use coolant whenever possible.

These tools permit a faster traverse rate providing a freer cutting wheel than when dressed by a conventional single-point tool.



Accessories

Tool holders typically used in toolroom applications.

Tool Holder/Hand Dresser

Designed for use when offhand truing and dressing on tool and cutter, or benchstand grinders. This stock hand dresser will not rust, and is 10-1/2" long, with a hollow shaft that accepts any tool shank length from 3/4" to 9". The 1-3/4" diameter plastic knob ensures a firm grip. The collet accepts a 7/16" diameter tool shank.

DESCRIPTION	PART NUMBER
Hand Dresser	66260195020

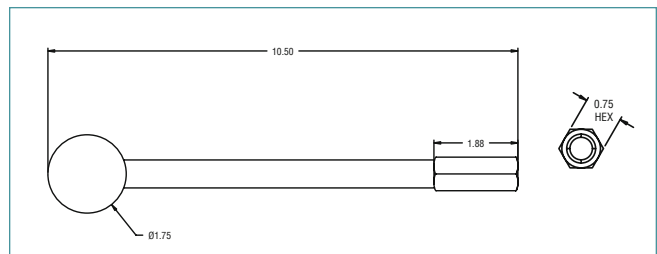



CATEGORY DEFINITION

Open or Closed Dressing... You Can Count on Fliesen Tools

Whether dressing a wheel OPEN or CLOSED you can count on Fliesen tools. Open wheels (sharp, free-cutting abrasive grains are exposed) are created by increasing the speed a Fliesen tool moves across the wheel when dressing. Generally considered the most favorable wheel conditioning, open wheels avoid workpiece burn while maximizing a wheel's ability to remove metal quickly when grinding.

Slowing a Fliesen tool as it moves across the wheel creates a closed wheel condition (abrasive grains are smoother, less sharp), a very helpful condition when trying to lower part surface finish readings.

- Harder, H-bond metal formulation tools have been specifically engineered to efficiently dress durable silicon carbide and ceramic wheels
- Furioso Fliesen tools have a unique bond system developed for optimal performance when dressing Norton Quantum (NQ) ceramic wheels
- W-bond Fliesen tools are designed for conventional aluminum oxide wheels

The Benefits of Fliesen Tools

Spend More Time Grinding

Single point, chisel, and cone point tools require operator attention to ensure proper tool rotation at regular intervals. Fliesen tools require no adjustments. Simply install the tool, dress the wheel to break it in, and the tool will do the rest. Operators spend more time grinding – rather than making non-productive dressing adjustments.

Longer Tool Life

Expect long life when using a Fliesen tool. Other stationary tools, made with a single diamond stone, develop flat spots (“wear flats”) over time – which create chatter and burn. Fliesen tools use hand-set, fine diamond grit, eliminating the creation of wear flats.

Fliesen Tool Configurations: Plate and Shank

Fliesen tools are available in two basic tool configurations. The most common is a plate configuration, which is somewhat rectangular-shaped with a mounting hole. Fliesen shank tool configurations are plates mounted in shanks of varying sizes and shapes. Most grinding machines accommodate one or the other tool configuration. To find the correct tool configuration for your machine, check the existing dressing tool, or consult your grinding machine manual.

Choosing The Correct Fliesen Tool

Using the chart below, find your desired wheel form – then locate the preferred diamond position. Next, find the correct tool configuration for your machine: plate or shank tool. Follow down that column to find the Fliesen page for your plate or standard shank tool configuration. Go to the appropriate page. Locate the corresponding zone for your wheel diameter and width on the graph. Find that zone number in the part number chart. Next, moving to the right, find your wheel abrasive type and grit size. Locate the part number for your Fliesen tool.

DESIRED WHEEL FORM					
DIAMOND POSITIONS	 BLADE ONLY FR	 SIDE-MOUNTED FRS, FAS, FBS, FCS, FDS	 CENTER-MOUNTED FAS, FBS, FCS & FDS	 DOUBLE-SIDED FCSD & FDSD	 TWIN FDST, FSST, AND 1TFAS

TOOL CONFIGURATION					
PLATES	 CONSULT CUSTOMER SERVICE	PAGE 265 – 266	CONSULT CUSTOMER SERVICE	CONSULT CUSTOMER SERVICE	PAGE 265 – 266
SHANK TOOLS	 CONSULT CUSTOMER SERVICE	CONSULT CUSTOMER SERVICE	CONSULT CUSTOMER SERVICE	CONSULT CUSTOMER SERVICE	CONSULT CUSTOMER SERVICE



Furioso Tools

The new generation of highly wear-resistant stationary diamond dressing tools for dressing modern ceramic abrasives

Performance Advantage

Furioso vs. Standard Blade

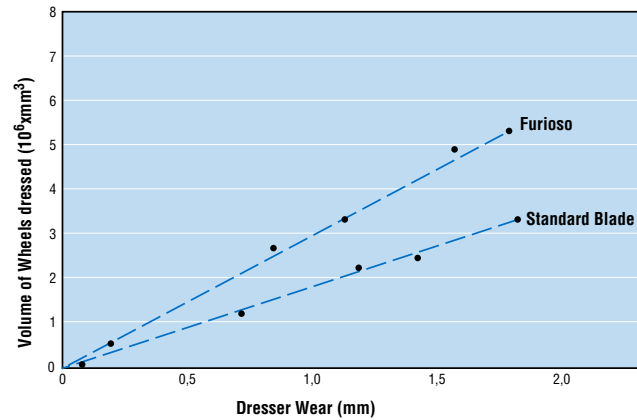

FURIOSO TOOLS

BEST CHOICE FOR OPTIMUM PERFORMANCE OF NORTON QUANTUM CERAMIC WHEELS

FEATURES

- The optimized combination of diamond quality, bond and setting pattern when dressing Norton Quantum (NQ) ceramic grinding wheels

BENEFIT

- Improved wear-resistance
- Excellent dressing behavior
- Constant surface roughness

Standard Furioso Plate Drawings

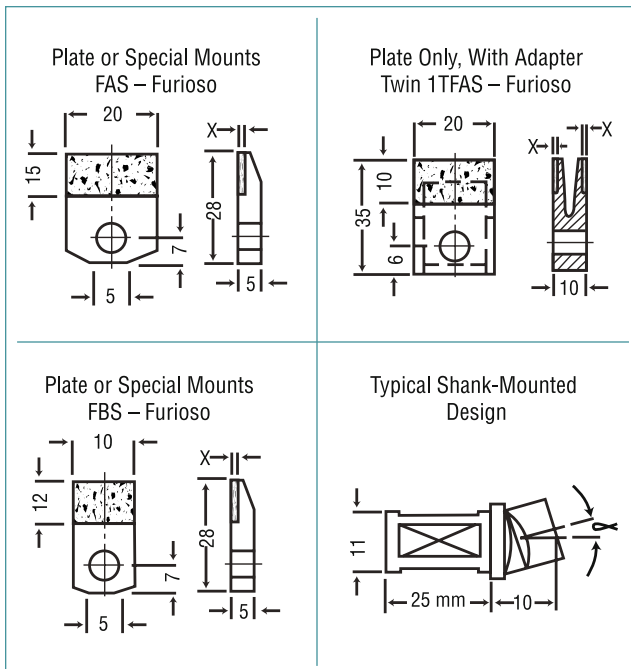

See the complete line of Norton Fliesen Tools

These two pages highlight a small sample of our Fliesen tool offering. Refer to our Diamond and cBN Superabrasive Standard Product Catalog #8068 sections or see the “Fliesen Tool” section on www.nortonindustrial.com or ask your Norton representative for complete product listing and information on these tools.

Furioso Plates; Side-Mounted and Twin

Use the Wheel/Tool Graph to identify your grinding wheel's Zone number, and the chart below to find the Furioso tool for your application.

Wheel / Furioso Tool Graph

Select Zone based on wheel diameter and width

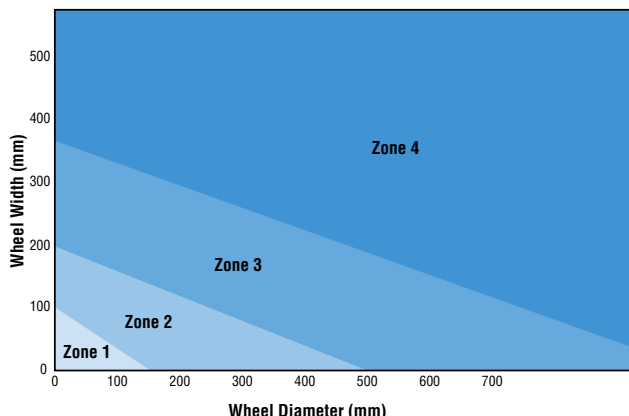

		BEST			
		TO DRESS: NORTON QUANTUM NQ CERAMIC WHEELS			
ZONE NO. / SERIES	WHEEL GRIT SIZE	TOOL #	PART #	DESCRIPTION	
Side-Mounted					
	ZONE 2	36 - 54	DT1463	69014122948 • FBS 140 Furioso	
	FBS Series	54 - 80	DT1462	69014122947 • FBS 115 Furioso	
		80 - 120	DT1461	69014122946 • FBS 90 Furioso	
		120 - 180	DT1460	69014122944 • FBS 75 Furioso	
	ZONE 3	36 - 54	DT1467	69014122952 • FAS 140 Furioso	
	FAS Series	54 - 80	DT1466	60157690579 • FAS 115 Furioso	
		80 - 120	DT1465	60157693885 • FAS 90 Furioso	
		120 - 180	DT1464	69014122950 • FAS 75 Furioso	
Twin					
	ZONE 4	36 - 54	DT1471	69014122956 • 1TFAS 140 Furioso	
	1TFAS Series	54 - 80	DT1470	69014122955 • 1TFAS 115 Furioso	
		80 - 120	DT1469	69014122954 • 1TFAS 90 Furioso	
		120 - 180	DT1468	69014122953 • 1TFAS 75 Furioso	

• ALL FURIOSO PLATES SHOWN SHIP IN 10 BUSINESS DAYS FROM RECEIPT OF ORDER.

SPECcheck

BLADE SIZE

DESCRIPTION DIMENSION

1	FBS	10 mm thick, 15 mm usable length
2	FAS	20 mm thick, 15 mm usable length
3	TFAS	Twin blade with cooling duct

DIAMOND GRIT SIZE

DESCRIPTION FEPA

140	D1181
115	D1001
90	D711
75	D501

Furioso Shank Tools

Made-to-order Furioso shank tools are also available. Ask your Norton representative for ordering assistance.

Side-Mounted Diamond Sections

Tools are available in different offset positions and angles.



OFFSET LEFT,
SPECIFY ANGLE
AMOUNT



ZERO OFFSET



OFFSET RIGHT,
SPECIFY ANGLE
AMOUNT

Tipping the Diamond Plates on Shank Tools

Diamond sections can be tipped right or left.



DIAMOND TIPPED
LEFT, SPECIFY
ANGLE



DIAMOND
TIPPED RIGHT,
SPECIFY ANGLE



THERE ARE MANY
DIFFERENT DIAMONDS
MAKING UP A SINGLE
PLATE AS THIS CUT-AWAY
VIEW SHOWS.



CATEGORY DEFINITION

Norton diamond rotary truing and dressing tools provide a very efficient way to modify the shape and topography of your grinding wheels.

PRODUCTS:

Form Rolls: plunge dressing
Infiltrated diamond form rolls
Reverse plated diamond form rolls

Dressing Discs: uni-axial traverse dressing
Infiltrated dressing discs
BPR dressing discs
IDW dressing discs

Truing and Dressing Spindles and Devices

Form Roll: Plunge Dressing

- Diamond roll geometry matches geometry of part to be ground
- Roll is fed into grinding wheel to generate the desired form and wheel surface condition
- Used where lowest cycle time and highest accuracy is required



Dressing Disc: Uni-Axial Traverse Dressing

- Diamond dressing disc has a thin diamond section that is traversed across the face of the grinding wheel
- Profile is generated with a CNC program or template
- Used for simple profiles or where flexibility is necessary

How to Order Rotary Dressing Tools

Provide the following information to your local sales representative or customer service representative

Legible blueprint of roll, wheel, or part with the following geometry:

- Overall diameter
- Overall length
- Bore size and tolerances required
- Mounting pattern
- Any feature with tolerances less than 0.0002" (5 μ m) must be clearly defined for engineering review.
- If designing from a part, a fully dimensioned part drawing is required
- Abrasive type (natural diamond, synthetic diamond, CVD stones, etc.)
- Specification of wheel to be dressed (need at least the grit type and size)
- Dressing type (Plunge or CNC Profiling)



Request the "Norton Rotary Truing and Dressing" brochure, form # 8535, and contact your Norton representative for more information and expert assistance with your dressing operation.



setting a new industry standard **FOR PRODUCTIVITY**

From the most comprehensive stock offering to the industry's largest custom-manufactured availability, Norton superabrasives give you the most choices to meet your application needs without compromising performance.

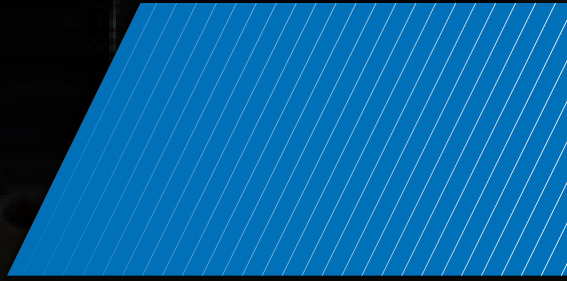

NORTON *PARADIGM*

A Paradigm Shift in Manufacturing
Online truing and dressing capability results in lower cutting energies with highest quality part edges and finish. Choose Paradigm stock or custom-manufactured to your exact requirements.

PanAmericanDistribution.com

NORTON *B99*

99 More Reasons to Choose Norton
The Norton "B99" line includes 250+ USA-made, ISO-certified, diamond and cBN products for precision finishing applications without the wait ... in stock and available now.

NORTON *SUPERHERO*

A Superhero CNC Standard Offering
Norton offers the broadest line of products to grind carbides, hardened steels and other hard-to-grind materials. Choose stock or custom-engineered made-to-order products

[Email: panamericandistribution@gmail.com](mailto:panamericandistribution@gmail.com)



CATEGORY DEFINITION

The “99” line of quality stock Diamond and cBN (cubic Boron Nitride) grinding products includes resin, vitrified, metal and MSL (metal single layer) bond offerings. Premium, high performance resin bond diamond and cBN wheels are also available.

APPLICATIONS: Norton B99 Diamond Wheels

- Sharpening cemented carbide cutting tools
- Cutting off carbide rod
- Grinding or cutting off non-ferrous materials such as ceramics or glass
- Surface grinding dies
- O.D. grinding spray coatings

Norton B99 cBN Wheels

- Sharpening high-speed (M2, D2, T15, etc.) steel cutting tools
- Surface and ID grinding hardened steel die components
- Precision grinding steel parts Rc 50 or harder

STOCK SHAPES: DW Mounted Points, HH1 and HH2 Hand Hones, and 1A1, 1A1R, 1V1P, 4A2P, 6A2C, 6A2H, 11V9, 12A2, 12V9, and 15V9 Wheels

ABRASIVE GRAIN: Diamond and cBN (cubic Boron Nitride)

ABRASIVE BONDS: Resin, Metal, Metal Single Layer, and Vitrified

STOCK DIAMOND WHEELS

FEATURES

- High quality synthetic diamond
- Pre-engineered resin bond – B99
- Premium, heavy-duty resin bond – B105
- Metal bond – M99
- MSL (metal single layer) diamond tools; no wheel dressing required
- Vitrified bond – V99

BENEFITS

- High material removal rates; longer wheel life vs. conventional green silicon carbide wheels
- Free cutting; superior form holding; efficient wet or dry
- Ideal for dry toolroom reconditioning applications
- Ideal for 1A1R cut-off applications and grinding glass or ceramic materials
- Fast stock removal, cool cutting; excellent for dry offhand finishing of carbide
- Most durable under high grinding forces; excellent for wet, offhand finishing of carbide tools

STOCK CBN WHEELS

FEATURES

- cBN (cubic Boron Nitride) abrasive material is second in hardness to diamond
- Pre-engineered resin bond – B99
- Premium Aztec III resin bond
- Premium Aztec .007 resin bond

BENEFITS

- Easily cuts difficult-to-grind steel parts Rc 50 or harder
- Highly wear resistant and thermally stable
- Free cutting, superior form holding
- Most efficient for dry tool resharping
- Most efficient for dry tool resharping where heavy stock removal is desired

TECHtip

- Truing makes the wheel concentric with the spindle
- Dressing opens the wheel’s cutting face
- Always true and dress diamond and cBN wheels prior to use
- Diamond and cBN wheels with grit sizes 100 – 180 can be trued with a Brake Controlled Truing Device
- Refer to the “Mounting, Truing and Dressing Guide” for more information



It is the user’s responsibility to refer to and comply with ANSI B7.1

NORTON DIAMOND PRODUCT IDENTIFICATION SYSTEM / USAGE INFORMATION

ASD 120 – R 75 B99 1/8

ABRASIVE TYPE	GRIT SIZE	GRADE	CONCENTRATION	BOND	ABRASIVE DEPTH
<p>ASD</p> <ul style="list-style-type: none"> Used with B99 and B105 bonds Armored Durable Versatile Use wet or dry Carbide/steel operations <p>CD</p> <ul style="list-style-type: none"> Used with B99 bond <p>D</p> <ul style="list-style-type: none"> Used with B99 bond Micron-sized diamond; finishing <p>M3D</p> <ul style="list-style-type: none"> Used with M99 bond <p>M4D</p> <ul style="list-style-type: none"> Used with M99 bond Armored Durable; for non-metallics <p>RMD</p> <ul style="list-style-type: none"> Used with V99 bond <p>SD</p> <ul style="list-style-type: none"> Used with B99 and V99 bonds Norton standard Use wet or dry Free cutting Low horsepower (3/4 hp or less) 	<ul style="list-style-type: none"> 100S – Roughing 120 – Roughing/cutting-off 150 – Combined roughing and finishing 180 – Improving finish 220, 320 & 400 – Finishing only 10/20 mic 6/12 mic 	<p>Resin Bond</p> <p>R – Norton standard N – Free cutting</p> <p>Metal Bond</p> <p>N – Norton standard</p> <p>Vitrified Bond</p> <p>P – Norton standard R – Most durable</p>	<p>50</p> <ul style="list-style-type: none"> Most economical For broad area of contact <p>75</p> <ul style="list-style-type: none"> Norton standard Freer cutting than 100 Dry grinding with ASD <p>100</p> <ul style="list-style-type: none"> Very durable For flood coolants Use with 220 grit or finer Use for cutting-off <p>115</p> <ul style="list-style-type: none"> For CNC grinding machines <p>125</p> <ul style="list-style-type: none"> Form holding For high volume, high pressure coolant, precision applications on high-speed tool steels 	<p>B99</p> <ul style="list-style-type: none"> Resin bond Use wet or dry Tool making; resharpening <p>B105</p> <ul style="list-style-type: none"> Premium resin bond Advanced heat-reducing bond Use dry; reconditioning <p>B610 and B80</p> <ul style="list-style-type: none"> For CNC grinding machines <p>M99</p> <ul style="list-style-type: none"> Metal bond 1A1R cut-off Glass and ceramics <p>MSL</p> <ul style="list-style-type: none"> Metal single layer Type 6A2C only Use dry Offhand reconditioning/finishing carbide <p>V99</p> <ul style="list-style-type: none"> Vitrified bond Offhand finishing of carbide tools Plunge grinding 	<ul style="list-style-type: none"> 1/16" 1/8" 1/4" 9/32" 3/8" 1/2" 3/4" solid

NORTON cBN PRODUCT IDENTIFICATION SYSTEM / USAGE INFORMATION

CB 120 – T B99 1/8

ABRASIVE TYPE	GRIT SIZE	GRADE	BOND	ABRASIVE DEPTH
<p>CB – cubic Boron Nitride</p> <ul style="list-style-type: none"> Used with B99 bond Armored Use wet or dry 	<ul style="list-style-type: none"> 100 – Roughing 120 – Roughing/cutting-off 150 – Combined roughing and finishing 180 – Improving finish 220, 320, 400 – For finishing only 	<p>Q</p> <ul style="list-style-type: none"> Approx. 50 concentration Type 6A2 Broad area of contact <p>T</p> <ul style="list-style-type: none"> Approx. 75 concentration Norton standard First choice Lower horsepower Broad area of contact Dry grinding Resharpening applications <p>W</p> <ul style="list-style-type: none"> Approx. 100 concentration Most durable High volume coolant Flute polishing Surface grinding Cylindrical grinding 	<p>B99</p> <ul style="list-style-type: none"> Resin bond Use wet or dry <p>Aztec III</p> <ul style="list-style-type: none"> Premium resin bond Use dry Tool resharpening <p>Aztec .007</p> <ul style="list-style-type: none"> Premium resin bond Use dry Increased feed rates Heavy stock removal Heavier cuts 	<ul style="list-style-type: none"> 1/16" 1/8" 1/4" 1/2" Solid

HOW TO SELECT NORTON STOCK DIAMOND WHEELS

SELECT

WHEEL DIMENSIONS	D x T x H	Select Diameter x Thickness x Hole from the availability tables. Use blueprint numbers where available.	
ABRASIVE	RESIN BOND WHEELS: ASD D SD METAL BOND WHEELS: M4D VITRIFIED BOND WHEELS: RMD SD	Armored diamond, durable. Versatile; can be used wet or dry. Also should be used when carbide and steel are ground in the same operation. Micron-sized diamond. Used for finishing and polishing operations. Free cutting standard. Used wet or dry; should be used on low horsepower (3/4 hp or less) machines. Armored, durable standard. A strong, blocky crystal designed for high performance on glass, ceramics, refractories and other non-metallics. Medium strength. Specifically designed for use with vitrified bonds. Free cutting standard.	Select the abrasive based on horsepower, grinding wet or dry, and contact with steel.
GRIT SIZE	100 120 150 180 220 320 400 10/20 Mic 6/12Mic	Roughing. The most common grit size for roughing operations. For roughing where 100 is too coarse. Also for cut-off applications. Medium stock removal plus good finish. For combined roughing and finishing applications. Medium stock removal plus good finish. To improve finish. Finishing Finishing Fine Finishing Super Fine Finishing Super Fine Finishing	Select the abrasive grit size based on finish and material removal rate required.
GRADE	RESIN BOND WHEELS: R N METAL BOND WHEELS: N VITRIFIED BOND WHEELS: P R	Norton standard Free cutting Norton standard Norton standard Most durable	The hardness of the wheel
CONCENTRATION	50 75 100 125	Most economical. For broad area of contact grinding. Norton standard. Freer cutting than 100 and the most economical for dry grinding with ASD diamond. Very durable. Recommended under flood coolant conditions; for use with 220 grit or finer, when durability is required, and for cut-off applications. Form holding. Used in high volume, high pressure coolant, precision applications on high-speed tool steels.	Select the abrasive concentration based on grinding wet or dry, material removal rates and form-holding requirements.
BOND	RESIN BOND: B99 B105 METAL BOND: M99 MSL VITRIFIED BOND: V99	Norton standard. Versatile enough to be used wet or dry on most tool making or sharpening applications. Premium, heat-reducing bond. For dry toolroom reconditioning applications. Best suited for 1A1R cut-off applications as well as grinding glass or ceramic materials. Metal Single Layer. Available in shape 6A2C for dry, offhand reconditioning of carbide tools. Best for wet offhand finishing of carbide tools as well as plunge grinding of carbide tools.	Select the bond based on the material being ground and grinding application.
ABRASIVE DEPTH	1/16 1/8 1/4 9/32 Solid		Usable abrasive

HOW TO SELECT NORTON STOCK cBN WHEELS

SELECT

WHEEL DIMENSIONS	D x T x H	Select Diameter x Thickness x Hole from the availability tables. Use blueprint numbers where available.	
ABRASIVE	RESIN BOND WHEELS: CB	Norton standard coated cBN (cubic Boron Nitride). Optimized for high performance in resin bond systems.	Select Norton cBN abrasive to grind hard tool steels such as A2, D2, T15, etc., and tough alloy steels.
GRIT SIZE	100 120 150	Roughing. The most common grit size for roughing operations. For roughing where 100 is too coarse. Also for cut-off applications. Medium stock removal plus good finish. For combined roughing and finishing applications.	Select the grit size based on finish and material removal rate required.
GRADE	Q T W	Approximately 50 concentration. Used on wide area of contact applications. Norton standard. Approximately 75 concentration. T is the first choice for lower horsepower equipment or large area of contact between the wheel and the work piece. Ideal for resharpening applications with 11V9, 12A2, 4A2P, and 15V9 wheel shapes when dry grinding. Most durable. Approximately 100 concentration, W is recommended for high volume coolant operations: flute grinding from solid, flute polishing, surface, and cylindrical grinding.	The hardness of the wheel
BOND	B99 Aztec III Aztec .007	Norton standard. Pre-engineered for optimal performance with cBN abrasive. Available in all shapes. The Norton advanced heat-reducing, lubricating resin bond. Used for dry grinding tool steels. The Norton premium resin bond for increased feed rates, high stock removal and heavier cuts – when dry grinding tool steels.	Select the bond depending on the type of grinding application.
ABRASIVE DEPTH	1/16 1/8 1/4 Solid		Usable abrasive

TECHtip

DIAMOND GRINDS:

In general, diamond is used to grind non-ferrous materials, because of an adverse reaction between diamond and iron.

- Cemented carbide
- Glass
- Ceramics
- Fiberglass
- Plastics
- Stone
- Abrasives
- Electronic components and materials

cBN GRINDS:

cBN is used to grind ferrous materials.

- High-speed tool steels
- Die steels
- Hardened carbon steels
- Alloy steels
- Aerospace alloys
- Hardened stainless steel
- Abrasion-resistant ferrous materials

Our Norton line offers a comprehensive stock product selection to service most of your needs – with the fastest delivery and lowest total costs.

Review this stock section first. If you can not find the specification you need:

- Then refer to the brief descriptions of our B99 Express and CNC lines (following this section)
- See the more in-depth B99 Express product availability in our "Diamond and cBN Superabrasives Standard Catalog" #8068 on www.nortonindustrial.com or contact your Norton representative for a complete listing of Norton made-to-order superabrasive products.



It is the user's responsibility to refer to and comply with ANSI B7.1

APPLICATION-TO-PRODUCT RECOMMENDATION GUIDE – DIAMOND WHEELS

APPLICATION OR COMMON MACHINE TYPE	COMMON WHEEL SIZE, TYPE & BLUEPRINT	APPLICATION VARIABLES	RECOMMENDED SPECIFICATION
Carbide Grinding – Toolroom Production			
Blanchard Grinding • Vertical Spindle Surface Grinding	10", 11", 16" & 18" diameters Type 2A2T	Wet – solid carbide • 1" or larger pieces – roughing • Small pieces Carbide & steel (combination)	SD100-R75B99E* ASD100-R75B99E* ASD100-R75B99E*
Hand • Burr Grinding	6" x 3/32" x 1-1/4" Type 1V1P V – 20° ME89562	Dry	ASDC320B-R125B99
Centerless (wet) • Throughfeed Grinding	12", 14", 16", 18" & 20" diameters Type 1A1	Roughing	ASD100-R75B99E*
• Unison Dedtru Grinder	7" x 1" x 1-1/4" Type 1A1		ASD150-R75B99E*
Cutting Off (wet)	6" x .035" x 1-1/4" Type 1A1R ME43572 10" x .050" x 1-1/4" Type 1A1R ME43565	• Most durable • Free cutting	ASD100S-R100B99 SD100-R75B99 SD120-R100B99
Cylindrical Grinding (wet)	10", 12", 14", 16" & 20" diameters Type 1A1	• Wet, rough grinding of cemented carbides, hard (55 Rc+) plasma and ceramic spray coatings • Wet, finish grinding of all carbides, plasma and ceramic spray coatings	ASD180-R100B99 ASD180-R75B99E* ASD150-R75B99 ASD120-R75B99 SD220-R100B99E*
Tool Sharpener Grinder (wet) • Bench Type	5" x 1" x 1-1/4" Type 6A2H ME27084 Rim Width (W) = 1-1/16	Tool sharpening	SD320-R50B99
Hand Honing (dry)	Various sizes Type HH1 or HH2		ASD100-R100B99 SD320-100V99
Lamination Dies (wet)	Various sizes Type 1A1	Surface grinding of carbide	ASD120-R75B99
Surface Grinding (wet) • Straight Wheels	Various sizes Type 1A1	Roughing • Durable • Free cutting Finishing only General purpose	ASD100S-R100B99E* SD100S-R100B99 SD220-R100B99 ASD150-R75B99 ASD120-R7599
Tool & Cutter Grinding	Various sizes Type 11V9, 12V9 or 15V9	Wet or dry	ASD120-R7599
Carbide Grinding – Offhand			
Single-Point Carbide Tools	6" x 3/4" x 1-1/4" Type 6A2C ME27853	Wet roughing • Durable • Free cutting Wet finishing • Durable • Free cutting Wet or dry grinding where free-cutting and self-dressing wheels are required • Roughing • Finishing	RMD150-P50V99* SD150-P50V99 RMD220-P50V99* SD220-P50V99 ASD120-R75B99 SD220-R50B99E*

NOTE: DIAMOND DEPTHS ARE NOT INDICATED IN ABOVE LISTINGS. WHEN ORDERING, BE SURE TO INCLUDE DIAMOND DEPTH (1/16, 1/8, ETC.).

*EXPRESS MADE-TO-ORDER; REFER TO THE B99E EXPRESS MADE-TO-ORDER WHEEL SECTION.

APPLICATION-TO-PRODUCT RECOMMENDATION GUIDE – cBN WHEELS

APPLICATION OR COMMON MACHINE TYPE	COMMON WHEEL SIZE, TYPE & BLUEPRINT	APPLICATION VARIABLES	RECOMMENDED SPECIFICATION
Toolroom Grinding			
Cutter Sharpening • Milling Cutters, Broaches, Reamers, etc.	3-3/4" x 1-1/2" x 1-1/4" Type 11V9 ME92192	Dry Wet	Aztec III 120T CB120-TB99
	6" x 1" x 1-1/4" Type 12A2 ME27758	Wet or dry	CB120-TB99
	6" x 3/4" x 1-1/4" Type 12V9 ME48666	Wet or dry	CB120-TB99
	6" x 3/4" x 1-1/4" Type 15V9 ME40633	Wet or dry	CB100-WB99E*
	10" x 1/2" x 3" Type 1A1	Wet or dry	CB100-TB99E*
Surface Grinding	12" x 1/2" x 3" Type 1A1	Wet or dry	CB150-WB99E*
Internal Grinding Tools	Thinner than 1/2" Type DW	Wet or dry	CB100-WB99
	1/2" or thicker Type 1A1	Wet or dry	CB120-TB99E*
Slotting	7" x .040" x 1-1/4" Type 1A1R	Water-base coolant	CB120-WB99E*

NOTE: CBN DEPTHS ARE NOT INDICATED IN ABOVE LISTINGS. WHEN ORDERING, BE SURE TO INCLUDE CBN DEPTH (1/16, 1/8, ETC.)
*EXPRESS MADE-TO-ORDER; REFER TO THE B99E EXPRESS MADE-TO-ORDER WHEEL SECTION.

CROSS REFERENCE GUIDE

	NORTON										
	ABRASIVES				BONDS						
	RESIN DIAMOND ASD	RESIN DIAMOND SD	METAL DIAMOND M4D	RESIN/VITRIFIED CBN CB	RESIN DIAMOND B99/B99E	RESIN DIAMOND B105	METAL DIAMOND M99	VITRIFIED DIAMOND V99	RESIN CBN B99/B99E	RESIN CBN B99EF	RESIN CBN AZTEC
3M / General Industrial Diamond / Diamond Productions, Inc	CGD, ND	GD, D, MD		CB	PS			V		BC	
Abrasive Technology	SN	S		cBN	B		M		B		
Accurate Diamond Tool	NCD	D, MD		BN	B		M				
Citco	5SD, 6SD	SD	MD	CB	B43, B52		M		B26	C3	
Engis	NMD	D, MD		cBN, CB							
Noritake				CBC		BX4			BD/B38		BX4
Radiac / US Diamond	NCD, WD, 1WD, MDC	D, MD	MD4C	B, CB, BZ	B7Z, BB, B5, B56, BN		M, MF	V	BZ, BN		
Regal Diamond				B, BB	BJ						
Superabrasives, Inc.	MDN	D, MD		B					B82	B5	
Tyrolit / Wickman / Bay State / Cincinnati	SDM, XDL, XDN, D, 7D, CMD	SD, D, 6D, MD	1D	5B, 1BN, BN, BM	BD, BC, BX33, B52, B6	Amigo	MI, MSS, MB		B72, B56, BG, B7	BXU8	Amigo
Wendt / Slip Naxos / Winterthur	SDK			B, BXW					RN	RR	

	NORTON POLYIMIDE			
	ABRASIVES		BONDS	
	UNIVEL/G-FORCE DIAMOND AD	cBN BX	DIAMOND AND cBN UNIVEL	DIAMOND AND cBN G-FORCE
3M / General Industrial Diamond / Diamond Productions, Inc	D	CB	BP	BPP
Citco	SD	CB	P	C5

TROUBLESHOOTING GUIDE – DRY GRINDING

PROBLEM	POSSIBLE CAUSES	SUGGESTED CORRECTION
Burning (excessive heat)	Wheel loaded or glazed Excessive feed rate Wheel too durable	Dress wheel with a dressing stick Reduce infeed of wheel or workpiece Use freer cutting specification or slow down wheel speed
Poor finish	Grit size too coarse Excessive feed rate	Select a finer grit size Reduce infeed of wheel or workpiece
Chatter	Wheel out of truth	True wheel; ensure it is not slipping on mount (See "Mounting, Truing and Dressing Guide")

TROUBLESHOOTING GUIDE – WET GRINDING

PROBLEM	POSSIBLE CAUSES	SUGGESTED CORRECTION
Burning (excessive heat)	Wheel glazed or loaded Poor coolant placement Excessive material removal rate	Re-dress wheel Apply coolant directly to wheel/workpiece interface Reduce downfeed and/or crossfeed
Poor finish	Excessive dressing Grit size too coarse Poor coolant flow or location	Use lighter dressing pressure Stop dressing as soon as wheel starts to consume stick rapidly Select a finer grit size Apply heavy flood so it reaches wheel/work interface
Chatter	Wheel out of truth	True wheel; ensure it is not slipping on mount
Wheel will not cut	Glazed by truing Wheel loaded	Dress lightly until wheel opens up Dress lightly until wheel opens up Increase coolant flow to keep wheel surface clean Never run wheel with coolant turned off
Slow cutting	Low feeds and speeds	Increase feed rate; increase wheel speed (Do not exceed wheel MOS)
Short wheel life	Incorrect coolant flow Low wheel speed Excessive dressing Wheel too soft or too hard	Apply coolant to flood wheel/work surface Increase wheel speed (observe maximum operating speed) Use lighter dressing pressure Change grit or grade; use higher concentration

MATERIAL HARDNESS SCALE

Superabrasives is a term used to describe those abrasives of extreme hardness which produce outstanding results when properly used on specific applications. This graph provides a hardness comparison (Knoop Hardness Scale) between diamond and cBN superabrasives, aluminum oxide and silicon carbide standard abrasives, and some common materials these abrasives are used to grind.

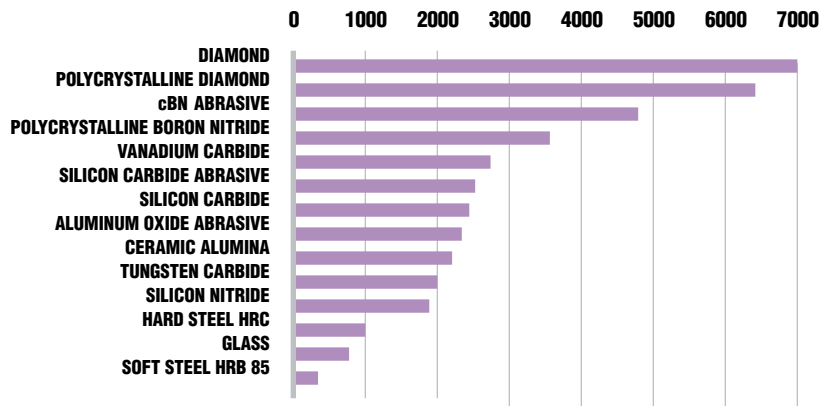

TECHtip

AVOID GRINDING STEEL

- Avoid steel when grinding with diamond wheels. Keep the amount of steel ground to an absolute minimum.
- On brazed tools, use aluminum oxide wheel to back off the steel shank.
- A high lubricity grinding fluid should be used.
- For some steels, an armored (AMD) diamond wheel might prove most economical.

USE RIGID WORK SUPPORT

- All workpieces should be supported firmly during the grinding process. Any amount of vibration will cause wheel wear and produce chatter or wave marks on the ground surface.
- On work ground between centers, centerholds should be properly prepared.
- Minimize work overhang.
- If the ground work is supported by a work finger, ensure the finger is strong enough to provide vibration-free support.

COOLANT – GRIND WET

- Diamond wheels should be used with a full flood coolant properly directed toward the grinding zone. Water with a rust inhibitor is recommended.
- Vitrified diamond wheels should be used only with a coolant.
- When flood application can't be used, try mist or spray application.
 - Use compressed air to "atomize" water or soluble oil.

- Direct the spray at the grinding zone to help dissipate heat and prevent heat damage to the work.

AVOID EXCESSIVE FEEDS

- Excessive feeds will result in premature wheel wear. Excessive feed rates are characterized by:
 - A hard grinding sound
 - Chatter
 - Burn
 - High wheel wear rate
 - Vibration

Decimal and Metric Equivalents of Common Fractions

FRACTIONS OF AN INCH	DECIMALS OF AN INCH	MILLIMETERS
1/64	.0156	0.397
1/32	.0313	0.794
3/64	.0469	1.191
1/16	.0625	1.588
5/64	.0781	1.985
3/32	.0938	2.381
7/64	.1094	2.778
1/8	.1250	3.175
9/64	.1406	3.572
5/32	.1563	3.969
11/64	.1719	4.366
3/16	.1875	4.762
13/64	.2031	5.159
7/32	.2188	5.556
15/64	.2344	5.953
1/4	.2500	6.350
17/64	.2656	6.747
9/32	.2813	7.144
19/64	.2969	7.541
5/16	.3135	7.937
21/64	.3281	8.334
11/32	.3438	8.731
23/64	.3594	9.128
3/8	.3750	9.525
25/64	.3906	9.922
13/32	.4063	10.319
27/64	.4219	10.716
7/16	.4375	11.112
29/64	.4531	11.509
15/32	.4688	11.906
31/64	.4844	12.303
1/2	.5000	12.700
33/64	.5156	13.097
17/32	.5313	13.494
35/64	.5469	13.891
9/16	.5625	14.287
37/64	.5781	14.684
19/32	.5938	15.081
39/64	.6094	15.478
5/8	.6250	15.875
41/64	.6406	16.272
21/32	.6563	16.688
43/64	.6719	17.085
11/16	.6875	17.462
45/64	.7031	17.859
23/32	.7188	18.256
47/64	.7344	18.653
3/4	.7500	19.050
49/64	.7645	19.447
25/32	.7813	19.843
51/64	.7969	20.240
13/16	.8125	20.637
53/64	.8281	21.034
27/32	.8438	21.430
55/64	.8594	21.827
7/8	.8750	22.224
57/64	.8906	22.621
29/32	.9063	23.018
59/64	.9219	23.415
15/16	.9375	23.812
61/64	.9531	24.209
31/32	.9688	24.606
63/64	.9844	25.003
1	1.0000	25.400

Expected Surface Finish by Grit Size

Use these charts as guides only. Surface finish is affected by several variables: machine type and condition, type of material ground, coolant, wheel speed, bond system, etc.

Diamond GRIT SIZE	EXPECTED FINISH MICRO INCH AA	MAXIMUM DEPTH OF CUT PER PASS FOR GRIT SIZE
100	24 to 32	0.001" to 0.002"
120	16 to 18	0.001" to 0.002"
150	14 to 16	0.001" to 0.002"
180	12 to 14	0.0007" to 0.001"
220	10 to 12	0.0007" to 0.001"
320	8	0.0004" to 0.0006"
400	7 to 8	0.0003" to 0.0005"

cBN GRIT SIZE	EXPECTED FINISH WITH OSCILLATION	EXPECTED FINISH PLUNGE
100	35 – 40	40 – 45
120	30 – 35	35 – 40
150	25 – 30	30 – 35
180	20 – 25	25 – 30
220	15 – 20	20 – 25
320	10 – 15	15 – 20
400	4 – 8	5 – 10

Recommended Wheel Speeds for Diamond and cBN Wheels

WET GRINDING

	CUP WHEELS	PERIPHERAL WHEELS
DIAMOND GRINDING WHEELS		
Resin Bond Wheels	11V9, 12V9, 15V9, etc. 4921 to 7874 SFPM 25 to 40 m/s	1A1, 1V1, 1A1R, etc. 4921 to 7874 SFPM 25 to 40 m/s
Metal Bond Wheels		3937 to 5906 SFPM 20 to 30 m/s
Vitrified Bond Wheels	2953 to 5906 SFPM 15 to 30 m/s	2953 to 5906 SFPM 15 to 30 m/s

cBN GRINDING WHEELS

Resin Bond Wheels	5906 to 9843 SFPM 30 to 50 m/s	5906 to 9843 SFPM 30 to 50 m/s
--------------------------	-----------------------------------	-----------------------------------

DRY GRINDING

	CUP WHEELS	PERIPHERAL WHEELS
DIAMOND GRINDING WHEELS		
Resin Bond Wheels	11V9, 12V9, 15V9, etc. 2756 to 3543 SFPM 14 to 18 m/s	1A1, 1V1, 1A1R, etc. 2756 to 3543 SFPM 14 to 18 m/s
cBN GRINDING WHEELS		
Resin Bond Wheels	2953 to 5906 SFPM 15 to 30 m/s	2953 to 5906 SFPM 15 to 30 m/s

NOTE: THESE ARE NOT THE MAXIMUM OPERATING SPEEDS (MOS). CONSULT ANSI B7.1 OR CONTACT YOUR NORTON REPRESENTATIVE FOR MOS.

Wheel Speed Calculation

To convert m/s to SFPM:	Multiply M/S x 196.85 = SFPM
To convert SFPM to M/S:	Divide SFPM by 196.85 = M/S
To convert RPM to SFPM:	Multiply wheel diameter in inches x RPM x 0.262

M/S = METERS/SECOND RPM = REVOLUTIONS PER MINUTE SFPM = SURFACE FEET PER MINUTE

Type DW

- D - DIAMETER
- T - THICKNESS
- Y - SPINDLE DIAMETER
- SP - SPINDLE LENGTH

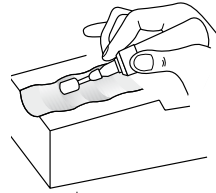
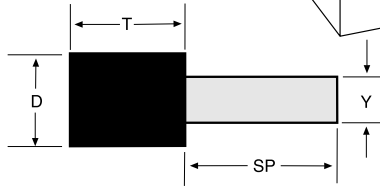

Type HH1

- L - LENGTH
- L1 - LENGTH OF ABRASIVE
- X - ABRASIVE DEPTH
- W - WIDTH
- T - THICKNESS (BACK)

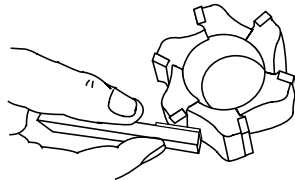
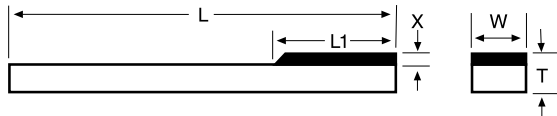

Type HH2

- L - LENGTH
- L1 - LENGTH OF ABRASIVE
- X - ABRASIVE DEPTH
- W - WIDTH
- T - THICKNESS (BACK)

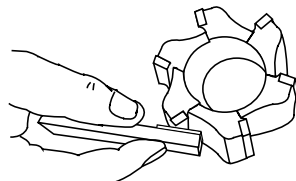
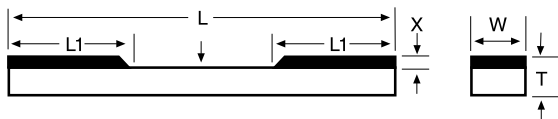

Type 1A1

- D - DIAMETER
- X - ABRASIVE DEPTH
- H - HOLE
- T - THICKNESS

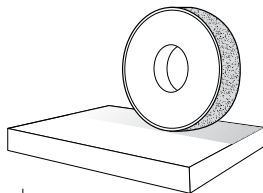
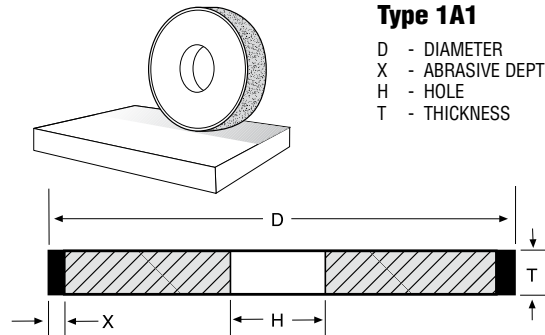

Type 1A1R

- D - DIAMETER
- X - ABRASIVE DEPTH
- H - HOLE
- E - BACK THICKNESS
- T - THICKNESS

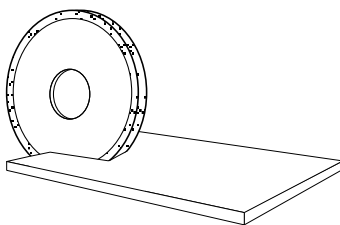
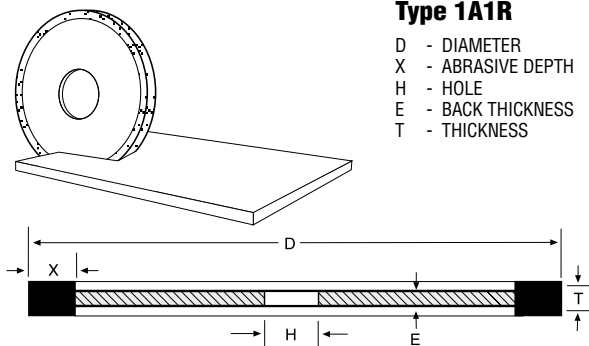

SIZE (D x T)	SPECIFICATION	PART #
Type DW Mounted Points – Diamond		
3/16 x 1/4	SD100-R100B99-SOLID	69014192238
Steel Spindle 1/8 x 1-1/2		
1/2 x 1/2	SD220-R100B99-SOLID	69014192249
Steel Spindle 1/4 x 1-1/2		
3/4 x 3/8	SD150-R100B99-SOLID	69014192251
Steel Spindle 1/4 x 1-1/2		
1 x 1/2	SD100-R100B99-SOLID	69014192428
Steel Spindle 1/4 x 1-1/2		
Type DW Mounted Points – cBN		
3/16 x 1/4	CB150-WB99-SOLID	69014192258
Carbide Spindle .125 x 1-3/4		
SIZE (T x W x L)	SPECIFICATION	PART #
Type HH1 Hand Hones – Diamond		
1/4 x 1/4 x 6	ASD220-R100B99-1/16	69014192139
One 1/16 deep 1" long insert in one 1/4 surface		
1/4 x 3/8 x 4	ASD100-R100B99-1/16	69014192141
One 1/16 deep	ASD180-R100B99-1/16	69014192142
1" long insert in one 3/8 surface	ASD220-R100B99-1/16	69014191670
	ASD320-R100B99-1/16	69014191672
	ASD400-R100B99-1/16	69014192143
	D10/20MIC-R100B99-1/16	69014192144
	SD320-100V99-1/16	69014192140
Type HH2 Hand Hones – Diamond		
1/4 x 3/8 x 4	ASD120/220-R100B99-1/16	69014192150
Two 1/16 deep 1" long inserts in one	ASD220/320-R100B99-1/16	69014192178
3/8 surface	ASD220/400-R100B99-1/16	69014192179
	ASD320/400-R100B99-1/16	69014192180
	SD220/320-100V99-1/16	69014192149
SIZE (D x T x H)	SPECIFICATION	PART #
Type 1A1 Straight – Diamond		
1 x 1/4 x 1/4	SD100-R100B99-1/8	69014192175
1-1/2 x 1/2 x 1/2	D6/12MIC-N100B99-1/8	69014192176
2 x 1/8 x 1/4	SD100-R100B99-1/8	69014192184
3 x 1/4 x 3/4	SD180-N100B99-1/8	69014192187
4 x .020 x 1-1/4	SD320-R100B99-1/8	69014192188
4 x 1/32 x 1-1/4	SD100S-R100B99-1/4	69014192192
4 x 1/16 x 1-1/4	SD100S-R100B99-1/4	66260273583
	SD150-R100B99-1/4	66260273584
	SD220-R100B99-1/4	66260273586
4 x 1/8 x 3/4	SD150-R100B99-1/4	69014192024
4 x 1/8 x 1-1/4	SD150-R100B99-1/4	69014191677
4 x 1/4 x 1/2	SD150-R100B99-1/4	66260273590
4 x 1/4 x 3/4	SD150-R100B99-1/4	66260273592
4 x 1/4 x 1-1/4	SD100S-R100B99-1/4	66260273587
	SD120-R100B99-1/4	66260273588
	SD150-R100B99-1/4	66260273589
4 x 1/2 x 1-1/4	SD150-R100B99-1/4	66260273594
6 x 1/32 x 1-1/4	SD220-R100B99-1/4	69014192197
6 x 1/16 x 1-1/4	SD100-R100B99-1/4	66260273596
	SD150-R100B99-1/4	66260273597
	SD180-R100B99-1/4	66260273598
	SD220-R100B99-1/4	66260273599
6 x 1/8 x 1-1/4	ASD150-R75B99-1/4	66260273617
	SD100-R100B99-1/4	66260273611
	SD150-R100B99-1/4	66260273613
	SD180-R100B99-1/4	66260273614
	SD220-R100B99-1/4	66260273615
6 x 1/4 x 1-1/4	ASD100S-R75B99-1/4	69014192205
	ASD120-R75B99-1/4	69014192769
	ASD150-R75B99-1/4	66260273609
	ASD180-R75B99-1/4	69014192770
	ASD220-R75B99-1/4	69014192771
	ASD320-R75B99-1/4	69014192772
	RMD180-P100V99-1/8	69014192203
	SD120-R100B99-1/4	69014191691
	SD150-R100B99-1/4	69014191692
	SD180-R100B99-1/4	69014191693
	SD220-R100B99-1/4	69014192764

STANDARD PACKAGE = 1 MOUNTED POINT, HAND HONE, OR WHEEL
CONTINUED

SIZE (D x T x H)	SPECIFICATION	PART #
Type 1A1 Straight – Diamond (cont'd)		
6 x 3/8 x 1-1/4	ASD120-R75B99-1/4	69014192773
	ASD150-R75B99-1/4	69014191695
	SD150-R100B99-1/4	69014191696
6 x 1/2 x 1-1/4	ASD120-R75B99-1/4	69014192777
	ASD150-R75B99-1/4	69014191698
	ASD220-R75B99-1/4	69014192779
	ASD320-R75B99-1/4	69014192780
	SD120-R100B99-1/4	66260273557
7 x 1/4 x 1-1/4	SD150-R100B99-1/4	66260273561
	SD180-R100B99-1/4	69014191700
	ASD150-R75B99-1/4	69014191701
	SD100S-R100B99-1/4	69014192210
	SD120-R100B99-1/4	66260273566
7 x 3/8 x 1-1/4	SD150-R100B99-1/4	69014191703
	SD180-R100B99-1/4	69014191704
	SD220-R100B99-1/4	69014191705
	SD120-R100B99-1/4	69014191849
	SD220-R100B99-1/4	69014191852
7 x 1/2 x 1-1/4	ASD100-R75B99-1/4	69014192211
	ASD150-R75B99-1/4	69014191853
	ASD180-R75B99-1/4	69014192212
	SD120-R100B99-1/4	69014191854
	SD150-R100B99-1/4	69014191855
8 x 1/2 x 1-1/4	SD150-R100B99-1/4	66260273574
	SD220-R100B99-1/4	69014191857
10 x 1/2 x 3	ASD120-R75B99-1/4	69014192305
	ASD180-R100B99-1/4	69014192306
12 x 1/2 x 3	ASD150-R75B99-1/4	69014192310
12 x 1/2 x 5	ASD150-R75B99-1/4	69014192311
12 x 1 x 3	ASD120-R75B99-1/4	69014192312
12 x 1 x 5	ASD120-R75B99-1/4	69014192313
14 x 1/2 x 5	ASD150-R75B99-1/4	69014192314
14 x 1 x 5	ASD120-R75B99-1/4	69014192316
20 x 1 x 12	ASD120-R75B99-1/4	69014192325

STANDARD PACKAGE = 1 WHEEL

SIZE (D x T x H)	SPECIFICATION	PART #
Type 1A1 Straight – cBN		
6 x 1/8 x 1-1/4	CB120-TB99-1/4	66260273601
6 x 1/4 x 1-1/4	CB120-TB99-1/4	66260273605
6 x 1/2 x 1-1/4	CB120-TB99-1/4	66260273607
7 x 1/4 x 1-1/4	CB120-TB99-1/4	69014192021
7 x 1/2 x 1-1/4	CB120-TB99-1/4	66260273567
12 x 1/2 x 5	CB150-TB99-1/4	66260273560
12 x 1 x 5	CB150-TB99-1/4	66260273562
Type 1A1R Cut-Off – Diamond		
3 x .020 x 1/2 (ME104177)	M4D150-N50M99-1/8	69014192060
4 x .012 x 1/2 (ME104180)	M4D180-N75M99-1/8	69014192063
	M4D220-N75M99-1/8	69014192064
4 x .020 x 1/2 (ME104180)	M4D220-N100M99-1/8	69014192067
	M4D150-N75M99-1/8	69014192068
4 x 1/32 x 3/4 (ME43570)	SD100S-R100B99-1/4	69014192151
	SD120-R100B99-1/4	69014191706
4 x 1/32 x 1-1/4 (ME43570)	SD100S-R100B99-1/4	69014192152
5 x .015 x 1/2 (ME104180)	M4D220-N100M99-1/8	69014192070
6 x .017 x 1-1/4 (ME104180)	M4D150-N100M99-1/8	69014192082
	M4D220-N100M99-1/8	69014192083
6 x .025 x 1-1/4 (ME104180)	M4D150-N100M99-1/8	69014192086
6 x .035 x 5/8 (ME104177)	M4D100-N75M99-1/8	69014192088
6 x .035 x 1-1/4 (ME43572)	SD100-R75B99-1/4	69014192155
	ASD100S-R100B99-1/4	69014192158
	ASD120-R100B99-1/4	69014192159
	SD100-R100B99-1/4	69014191858
	SD100S-R100B99-1/4	69014192156
	SD220-R100B99-1/4	69014192157

CONTINUED

TECHtip

CYLINDRICAL GRINDING APPLICATIONS – 1A1 WHEELS:

- Includes all outside grinding of round parts, even though the finished product is not always a true cylinder.
- Infeed at both ends of the traverse to keep wheel face flat.
- Use work supports to prevent deflection.
- Rough grinding traverse speed should be 1/2 to 2/3 of the thickness of the wheel per work revolution.
- Finishing grinding traverse speed should be 1/2" or less per work revolution.

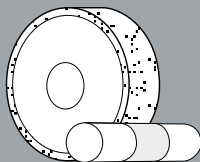

It is the user's responsibility to refer to and comply with ANSI B7.1

DIAMOND GRINDS:

- Cemented carbide
- Glass
- Ceramics
- Fiberglass
- Plastics
- Stone
- Abrasives
- Electronic components and materials

cBN GRINDS:

- High-speed tool steels
- Die steels
- Hardened carbon steels
- Alloy steels
- Aerospace alloys
- Hard stainless steel
- Abrasion-resistant ferrous materials

TECHtip

CUT-OFF APPLICATIONS – 1A1R WHEELS:

- Use the largest diameter flanges possible
- Use flanges of equal diameter
- Use the thickest wheel possible for increased stiffness and straightness of cut

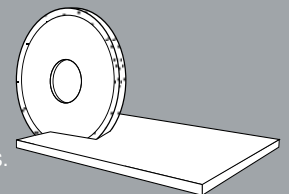

cBN wheels are used on hardened steels.

Diamond wheels are used to cut or slot carbide, glass or ceramic parts.



It is the user's responsibility to refer to and comply with ANSI B7.1

Can't Find Your Specification Here?

Review this stock section first. If you can not find the specification you need:

- Then refer to the brief descriptions of our B99 Express and CNC lines (following this section)
- See the more in-depth B99 Express product availability in our "Diamond and cBN Superabrasives Standard Catalog" #8068 on www.nortonindustrial.com or contact your Norton representative for a complete listing of Norton made-to-order superabrasive products.

SIZE (D x T x H)	SPECIFICATION	PART #
Type 1A1R Cut-Off – Diamond		
6 x .035 x 1-1/4 (ME83316)	ASD100S-R100B99-9/32 ASD120-R100B99-9/32	69014192164 69014192165
	SD100-R100B99-9/32 SD120-R100B99-9/32 SD150-R100B99-9/32	69014192161 69014192162 69014192163
6 x .045 x 1-1/4 (ME83991)	SD100-R50B99-1/8	69014192166
6 x .055 x 1-1/4 (ME104177)	M4D100-N75M99-1/8	69014192099
7 x .035 x 1-1/4 (ME82347)	ASD100-R100B99-1/4	66260238686
7 x .055 x 1-1/4 (ME104177)	M4D120-N100M99-1/8	69014192108
8 x .030 x 1-1/4 (ME104180)	M4D180-N75M99-1/8	69014192110
8 x .045 x 5/8 (ME43569)	SD120-R100B99-1/4	69014192167
8 x .045 x 1-1/4 (ME43569)	SD120-R100B99-1/4	69014192169
8 x .050 x 1-1/4 (ME104180)	M4D180-N75M99-1/8	69014192114
10 x .050 x 1-1/4 (ME 43565)	ASD120-R100B99-1/4 CD100-R100B99-1/4 SD120-R100B99-1/4	66260230236 69014192815 69014192170
10 x .050 x 3 (ME 43565)	ASD100S-R75B99-1/4	69014192172
12 x .070 x 3/4 (ME 43567)	SD150-R100B99-1/4	69014192173
14 x .070 x 3/4 (ME 106589)	SD120-R100B99-1/4	66260259011
Type 1A1R Cut-off – cBN		
6 x .035 x 1-1/4 (ME43572)	CB100-WB99-1/4	69014192160
Type 1V1P Fluting – Diamond		
6 x 3/32 x 1-1/4 Face Bevel 1 Side 20 Deg Copper Core (ME89562)	ASDC320C-R100B99-1/4 ASD320B-R125B99-1/4	69014192761 69014192302
Type 4A2P Dish – Diamond		
6 x 3/8 x 1-1/4 Rim Width 1/4" (ME88369)	ASD120-R75B99-1/16	69014192280

STANDARD PACKAGE = 1 WHEEL

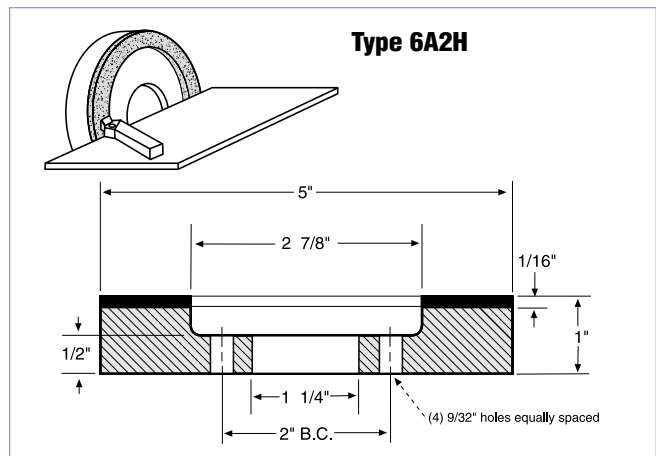
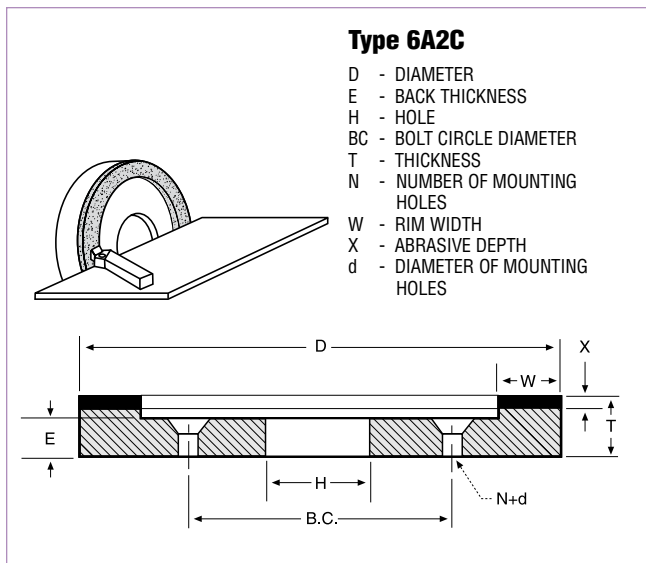
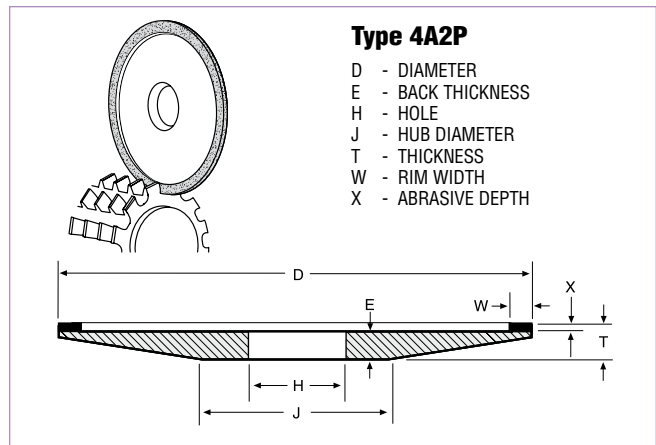
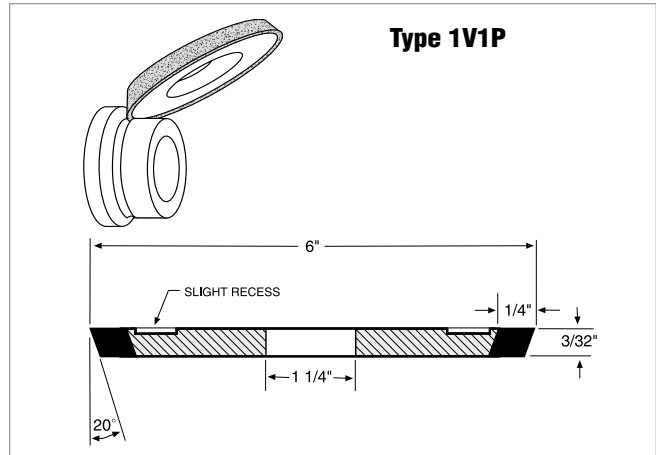
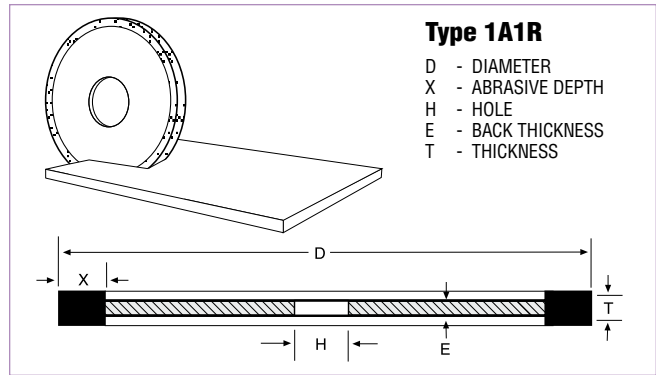

Refer to "Brake Controlled Truing Devices" and "Dressing Sticks" sections for truing and dressing products.

SIZE (D x T x H)	SPECIFICATION	PART #
Type 6A2C Straight cup – Diamond		
6 x 7/16 x 1-1/4 Rim Width 1" (0640185M)	D120/140-H-MSL	66260269172
6 x 3/4 x 1-1/4 Rim Width 3/4" (ME27853)	SD220-R50B99-1/16	69014191665
	ASD120-R75B99-1/16	69014191860
	ASD120-R75B99-1/8	69014192786
	SD150-P50V99-1/16	69014192217
6 x 3/4 x 1-1/4 Rim Width 1/2" (ME30621)	SD220-P50V99-1/16	69014191623
	ASD120-R75B99-1/8	66260273565

STANDARD PACKAGE = 1 WHEEL

SIZE (D x T x H)	SPECIFICATION	PART #
Type 6A2H Straight Cup – Diamond		
5 x 1 x 1-1/4 Rim Width 1-1/16" (ME27084)	SD320-R50B99-1/16	69014192221

STANDARD PACKAGE = 1 WHEEL

ASD DIAMOND / B105 RESIN BOND WHEELS
BEST CHOICE FOR DRY GRINDING CARBIDE TOOLS

FEATURES

BENEFITS

- | | |
|--------------------------------|---|
| ■ Premium quality diamond | ■ Produces keen cutting tools that hold their shape, are easier to sharpen, and require fewer reconditionings |
| ■ Advanced, heat-reducing bond | ■ Minimizes heat generation and thermal damage to tool |
| | ■ Increases tool life and productivity |
| | ■ Lasts more than 2X as long as standard diamond wheels |
| | ■ Lowest total wheel costs; highest productivity |
| ■ Self-lubricating bond | ■ No steel or braze loading |
| | ■ Uses less power |
| ■ Unique self-dressing core | ■ Eliminates wheel core damage |
| | ■ Eliminates downtime to dress core |

SIZE (D x T x H)	SPECIFICATION	PART #
Type 11V9 Flaring Cup – Diamond		
3-3/4 x 1-1/2 x 1-1/4 Insert Length 3/8" (ME92192)	ASD120-R75B105-1/16	69014191905
	ASD150-R75B105-1/16	69014191906
	ASD100S-R75B105-1/8	69014191908
	ASD120-R75B105-1/8	69014191909
5 x 1-3/4 x 1-1/4 Insert Length 7/16" (ME98298)	ASD150-R75B105-1/8	69014191910
	ASD120-R75B105-1/16	69014191913
	ASD150-R75B105-1/16	69014191914
	ASD100S-R75B105-1/8	69014191916
	ASD150-R75B105-1/8	69014191918

STANDARD PACKAGE = 1 WHEEL

SIZE (D x T x H)	SPECIFICATION	PART #
Type 11V9 Flaring Cup – Diamond		
3 x 1-1/4 x 3/4 Insert Length 3/8" (ME93912)	ASD120-R75B99-1/16	69014192291
	ASD150-R75B99-1/16	69014192292
	SD150-R100B99-1/16	69014192293
3-3/4 x 1-1/2 x 3/4 Insert Length 3/8" (M92192)	ASD120-R75B99-1/16	69014192022
3-3/4 x 1-1/2 x 1-1/4 Insert Length 3/8" (ME92192)	ASD150C-R50B99-1/8	69014190751
	ASD120-R75B99-1/16	69014191660
5 x 1-3/4 x 1-1/4 Insert Length 7/16" (ME98298)	ASD150-R75B99-1/16	69014191725
	ASD100S-R75B99-1/8	69014191653
	ASD120-R75B99-1/8	69014191652
	ASD150-R75B99-1/8	69014191651
	ASD180-R75B99-1/8	69014191650
	SD120-R100B99-1/16	69014191657
	SD150-R100B99-1/16	69014191656
	SD220-R100B99-1/16	69014191654
	SD320-R100B99-1/16	69014192814
	SD100S-R100B99-1/8	69014192427
	SD120-R100B99-1/8	69014191649
	SD150-R100B99-1/8	69014191648
	SD180-R100B99-1/8	69014191647
	SD220-R100B99-1/8	69014191646
	ASD100S-R75B99-1/16	69014191645
	ASD120-R75B99-1/16	69014191644
	ASD150-R75B99-1/16	69014191643
	ASD100S-R75B99-1/8	69014191637
	ASD120-R75B99-1/8	69014191636
	ASD150-R75B99-1/8	69014191635
ASD180-R75B99-1/8	69014191634	
SD120-R100B99-1/16	69014191641	
SD150-R100B99-1/16	69014191640	
SD220-R100B99-1/16	69014191638	
SD150-R100B99-1/8	69014191632	
SD180-R100B99-1/8	69014191631	

STANDARD PACKAGE = 1 WHEEL

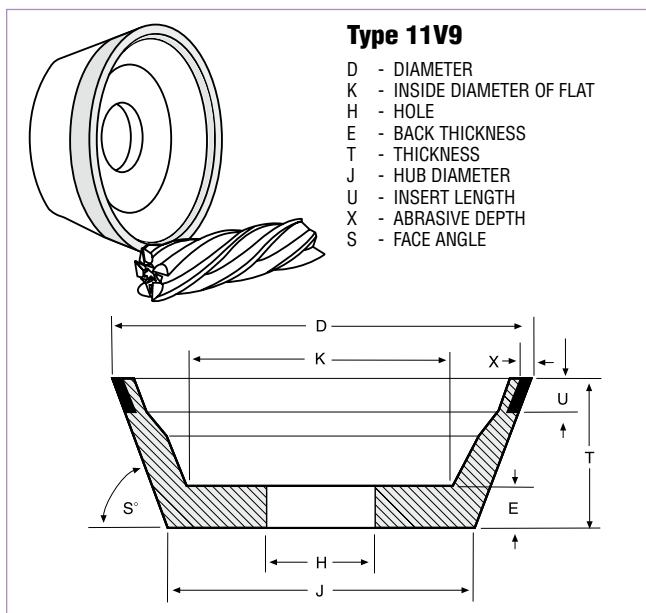

NORTON AZTEC CBN WHEELS
BEST CHOICE FOR DRY TOOL RESHARPENING

FEATURES

- Consistent, high quality cBN (cubic Boron Nitride) abrasive
- Advanced heat-reducing bond conducts heat away from the workpiece

BENEFITS

- 85% longer life than standard cBN wheels
- Eliminates heat build-up and damage
- Extends wheel life
- Freer cutting action
- Maintains cutting tool steel integrity
- Extends cutting tool life

Aztec III

- Lubricating bond
- Eliminates steel and braze loading
- Reduces drag
- Allows greater infeeds

Aztec .007

- Allows increased infeed (start at .007)
- High stock removal rate
- Heaviest cuts with less wheel wear
- Lower grinding forces
- Elimination of chatter

SIZE (D x T x H)	SPECIFICATION	PART #
Type 11V9 Flaring Cup – cBN		
3-3/4 x 1-1/2 x 1-1/4 Insert Length 3/8" (ME92192)	AZTEC .007-100-1/16	69014195683
	AZTEC .007-150-1/16	69014195679
	AZTEC III 100T-1/16	69014191832
	AZTEC III 120T-1/16	69014191833
	AZTEC III 150T-1/16	69014191834
	AZTEC .007-150-1/8	69014195680
	AZTEC III 100T-1/8	69014191838
	AZTEC III 120T-1/8	69014191839
5 x 1-3/4 x 1-1/4 Insert Length 7/16" (ME98298)	AZTEC III 150T-1/8	69014191840
	AZTEC III 150W-1/16	69014191837
	AZTEC .007-100-1/16	69014195685
	AZTEC III 100T-1/16	69014191841
	AZTEC III 120T-1/16	69014191842
	AZTEC III 150T-1/16	69014191843
	AZTEC .007-100-1/8	69014195686
	AZTEC .007-150-1/8	69014195682
AZTEC III 100T-1/8	69014191844	

STANDARD PACKAGE = 1 WHEEL

SIZE (D x T x H)	SPECIFICATION	PART #
Type 11V9 Flaring Cup – cBN		
3-3/4 x 1-1/2 x 1-1/4 Insert Length 3/8" (ME92192)	CB100-TB99-1/16	69014191719
	CB100-TB99-1/8	69014191722
	CB120-TB99-1/8	69014191723
	CB150-TB99-1/8	69014191724
	CB120-WB99-1/16	69014191720
5 x 1-3/4 x 1-1/4 Insert Length 7/16" (ME98298)	CB120-TB99-1/8	69014191715
	CB150-TB99-1/8	69014191716

STANDARD PACKAGE – 1 WHEEL

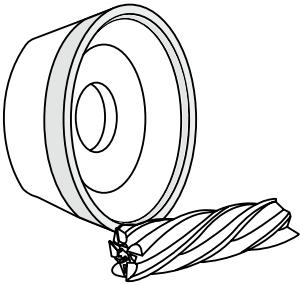

Type 11V9

D - DIAMETER
K - INSIDE DIAMETER OF FLAT
H - HOLE
E - BACK THICKNESS
T - THICKNESS
J - HUB DIAMETER
U - INSERT LENGTH
X - ABRASIVE DEPTH
S - FACE ANGLE

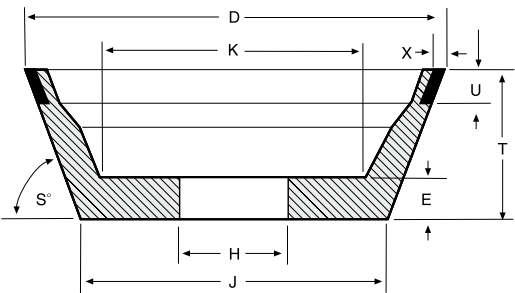

Refer to “Brake Controlled Truing Devices” and “Dressing Sticks” sections for truing and dressing products.

SIZE (D x T x H)	SPECIFICATION	PART #
Type 12A2 Dish – Diamond		
4 x 1/2 x 1-1/4 Rim Width 1/4" (ME40745)	SD180-R75B99-1/8	69014192223
6 x 1 x 1-1/4 Rim Width 3/16" (ME27758)	ASD120-R75B99-1/8 ASD180-R75B99-1/8	69014191630 69014192226
Type 12A2 Dish – cBN		
6 x 1 x 1-1/4 Rim Width 3/16" (ME27758)	CB120-TB99-1/16	69014192227
Type 12V9 Dish – Diamond		
3 x 7/16 x 3/4 Insert Length 7/16" (ME41755)	SD150-R100B99-1/16	69014192228
4 x 1/2 x 1-1/4 Insert Length 1/4" (ME58734)	SD180-R100B99-1/8	69014191629
6 x 3/4 x 1-1/4 Insert Length 3/8" (ME48666)	ASD150-R75B99-1/16	69014191628
Type 12V9 Dish – cBN		
4 x 1/2 x 1-1/4 Insert Length 1/4" (ME58734)	CB120-TB99-1/8	69014192229
6 x 3/4 x 1-1/4 Insert Length 3/8" (ME48666)	CB120-TB99-1/8 CB150-TB99-1/8	69014192020 69014192784
Type 15V9 Dish – Diamond		
6 x 3/4 x 1-1/4 Insert Length 3/8"	SD150-R100B99-1/16	69014192230

STANDARD PACKAGE = 1 WHEEL

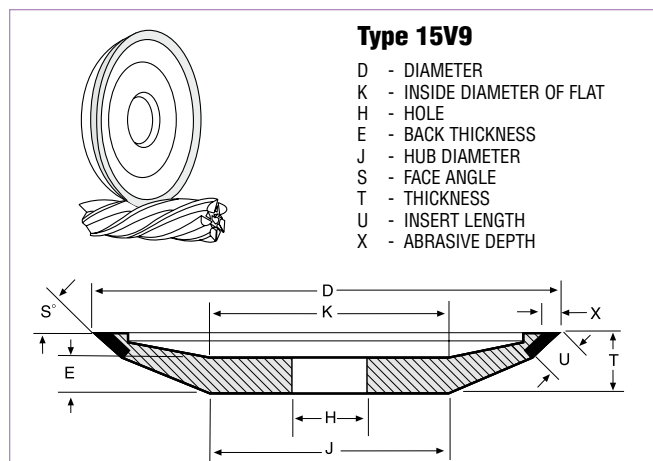
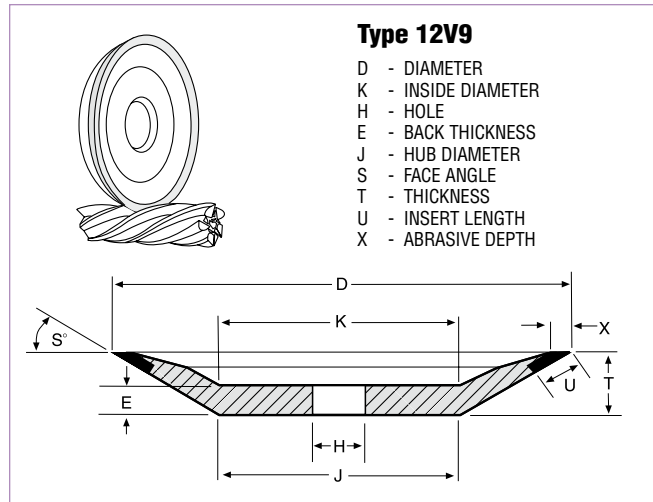
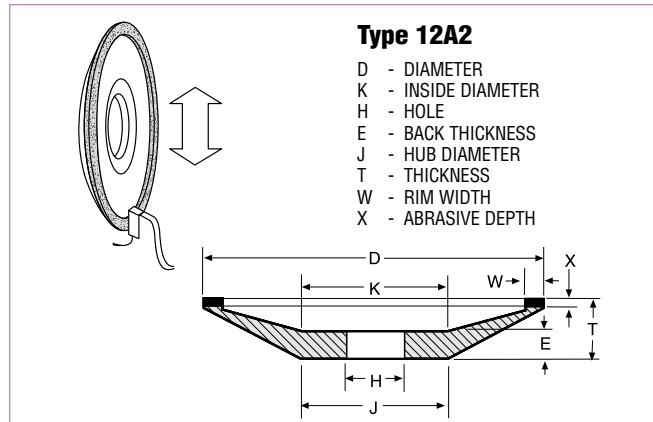

Norton offers a comprehensive stock product selection to service most of your needs – with the fastest delivery and lowest total cost.

Review this stock section first. If you can not find the specification you need:

- Then refer to the brief descriptions of our B99 Express and CNC lines (following this section)
- See the more in-depth B99 Express product availability in our "Diamond and cBN Superabrasives Standard Catalog" #8068 on www.nortonindustrial.com or contact your Norton representative for a complete listing of Norton made-to-order superabrasive products.



Norton B99 Express Service

The Norton B99 Express service is designed to offer you up to 65,000 made-to-order choices of resin bond Diamond and cBN wheels. Almost all popular sizes are offered.

12" and less diameter B99 Express wheels will ship in two weeks or less from the date the order is received by Norton. 14" and larger wheels are available at standard lead-times.

See the more in-depth B99 Express product availability in our "Diamond and cBN Superabrasives Standard Catalog" #8068 on www.nortonindustrial.com or contact your Norton representative for a complete listing of Norton made-to-order superabrasive products.



CATEGORY DEFINITION

65,000+ made-to-order resin products; 25 wheel shapes, with one- and two-week lead-times for 12" and less diameter wheels. 14" and larger wheels and 80 grit and coarser wheels are available with standard made-to-order lead-times. If you do not find the resin specification and/or shape you need in our stock offering, you will most likely find it in our B99 Express made-to-order offering.

APPLICATIONS:

Norton B99E Diamond Wheels

- Sharpening cemented carbide cutting tools
- Cutting-off carbide rod
- Grinding or cutting-off non-metallic materials such as ceramics or glass
- Surface grinding dies
- O.D. grinding spray coatings

Norton B99E cBN Wheels

- Sharpening high-speed (M2, D2, T15, etc.) steel cutting tools
- Surface and ID grinding hardened steel die components
- Precision grinding steel parts Rc 50 or harder

B99 EXPRESS MADE-TO-ORDER DIAMOND AND CBN RESIN BOND WHEELS

FEATURES

- Superior diamond and cBN abrasives in durable resin bond systems
- Thousands of abrasive, grit, grade, concentration, and bond combinations
- Made in our state-of the art, USA, ISO-certified facilities
- Priced as stock products
- Two-week (and less) lead-times

BENEFITS

- These quality wheels will get your job done
- There is a B99 Express wheel for almost every resin bond application
- Exceptional quality and performance
- Excellent performance/price ratio
- Minimal time from order to production floor

HOW TO SELECT B99 EXPRESS MADE-TO-ORDER DIAMOND WHEELS

SELECT

SHAPE			Specify desired wheel shape
WHEEL DIMENSIONS	D x T x H	Select Diameter x Thickness x Hole from the availability tables. Use blueprint numbers where available.	
ABRASIVE	ASD	Armored diamond; most durable. Versatile: can be used wet or dry. ASD should be used when carbide and steel are ground in the same operation.	Select the abrasive based on horsepower, grinding wet or dry, and contact with steel.
	SD	Free cutting standard. Can be used wet or dry; should be used on low horsepower (3/4 hp or less) machines.	
GRIT SIZE	80	Roughing	Select the grit size based on finish and material removal rate required. Note: Standard made-to-order lead-times apply to 80 grit and coarser wheels.
	100	Roughing. The most common grit size for roughing operations.	
	120	For roughing where 100 is too coarse. Also for cut-off applications.	
	150	Medium stock removal plus good finish. For combined roughing and finishing applications.	
	180	Medium stock removal plus good finish. To improve finish.	
	220	Finishing	
GRADE	R	Resin bond standard	The hardness of the wheel
	CONCENTRATION		
CONCENTRATION	50	Shape 2A2T only. For broad area of contact grinding.	Select the concentration based on grinding wet or dry, material removal rates, and form holding requirements.
	75	Norton standard. Freer cutting than 100 grit and the most economical for dry grinding with ASD diamond.	
	100	Very durable. Recommended under flood coolant conditions. For use with 220 grit or finer, when durability is required. Also for cut-off applications.	
	125	Improved form holding. Used with B99EF bond only for form holding in high-volume, high-pressure coolant applications. Used with ASD abrasive.	
BOND	B99E	Norton standard pre-engineered resin bond. Versatile enough to be used wet or dry on most tool making or resharpening applications as well as for grinding non-metallic materials such as ceramics or glass. Available in all shapes.	Select the bond based on the material being ground and grinding application.
	B99EF	Improved form holding. More durable than B99E. Improved heat dissipation in wet or dry applications. Available in wheel shapes 1V1, 1B1, 1E1, 1EE1, 1F1 and 1FF1.	
ABRASIVE DEPTH	1/16		Usable abrasive
	1/8		
	1/4		
	1/2		

HOW TO SELECT B99 EXPRESS MADE-TO-ORDER cBN WHEELS

SELECT

SHAPE			Specify desired wheel shape
WHEEL DIMENSIONS	D x T x H	Select Diameter x Thickness x Hole from the availability tables. Use blueprint numbers where available.	Note: Standard made-to-order lead-times apply to 14" and larger wheels.
ABRASIVE	CB	Norton standard coated cBN (cubic Boron Nitride). Optimized for high performance in resin bond systems.	Select Norton cBN abrasive to grind hard tool steels such as A2, D2, T15, etc., and tough alloy steels.
GRIT SIZE	100 120 150 180 220 320 400	Roughing. The most common grit size for roughing operations. For roughing where 100 is too coarse. Also for cut-off applications. Medium stock removal plus good finish. For combined roughing and finishing applications. Medium stock removal plus good finish. To improve finish. Finishing Finishing Fine finishing	Select the grit size based on finish and material removal rate required. Note: Standard made-to-order lead-times apply to 80 grit and coarser wheels.
GRADE	T W Z	Norton standard. Approximately 75 concentration, T is the first choice for lower horsepower equipment or wide area of contact between the wheel and the workpiece. Ideal for resharpening applications with 11V9, 12A2, 4A2P, and 15V9 wheel shapes when dry grinding. Very durable. Approximately 100 concentration, W is recommended for high volume coolant operations: flute grinding from solid, flute polishing, surface, and cylindrical grinding. Form holding. Approximately 125 concentration, Z grade is extremely durable and is recommended where long life or form holding is required in high-volume, high-pressure coolant applications. Used with B99EF bond only.	The hardness of the wheel
BOND	B99E B99EF	Norton standard resin bond. Pre-engineered for optimal performance with cBN abrasive. Available in all shapes. Improved form holding. More durable than B99E. Improved heat dissipation in wet or dry applications. Available in wheel shapes 1V1, 1B1, 1E1, 1EE1, 1F1 and 1FF1.	Select the bond depending on the type of grinding application.
ABRASIVE DEPTH	1/16 1/8 1/4 1/2		Usable abrasive

See the more in-depth B99 Express product availability in our "Diamond and cBN Superabrasives Standard Catalog" #8068 on www.nortonindustrial.com or contact your Norton representative for a complete listing of Norton made-to-order superabrasive products.

TECHtip

DIAMOND GRINDS:

In general, diamond is used to grind non-ferrous materials, because it reacts with iron.

- Cemented carbide
- Glass
- Ceramics
- Fiberglass
- Plastics
- Stone
- Abrasives
- Electronic components and materials

cBN GRINDS:

cBN is used to grind ferrous materials.

- High-speed tool steels
- Die steels
- Hardened carbon steels
- Alloy steels
- Aerospace alloys
- Hardened stainless steel
- Abrasion-resistant ferrous materials



It is the user's responsibility to refer to and comply with ANSI B7.1



CATEGORY DEFINITION

These superior, pre-engineered wheels have been specifically developed to meet the demanding needs of precision cutting tool manufactures as well as re-sharpeners. The use of the highest quality diamond and cBN abrasives matched to superior high temperature bond systems, guarantees high performing wheels. These wheels are manufactured under the strictest quality control protocols ensuring the same, consistent, high-performing product. Cutting tool manufactures who use these wheels report much improved dimensional accuracy and superior cutting edges.

This product offering provides wheel sizes for most CNC machines and wheels shapes to produce the required cutting tool geometries. If you do not find a wheel in this offering to suit your specific needs, a custom-made wheel can be provided.

APPLICATIONS: CNC cutting tool manufacturing and reshaping: fluting, end fluting, gashing, and OD relief

FEATURED PRODUCTS



NORTON PARADIGM DIAMOND WHEELS – FOR CNC WC ROUND TOOL MANUFACTURING
NORTON G-FORCE CBN WHEELS – FOR CNC HSS ROUND TOOL MANUFACTURING

FEATURES

- Trueable
- Wear and load resistant
- High grain retention; uniform structure
- Low specific cutting energy

BENEFITS

- Online and offline trueable, lights-out mfg. for maximum productivity
- Superior grinding on 6% to 12% cobalt
- Better control over core growth
- High G-ratio; up to 2.5 times longer life and 30% higher MRR than existing superabrasive wheels
- Faster grinding with lower power draw and less burn



NORTON G-FORCE AND UNIVEL POLYIMIDE DIAMOND WHEELS

BETTER CHOICE FOR CNC WC ROUND TOOL MANUFACTURING

FEATURES

Univel and G-Force Premium Products

- Polyimide bond systems

BENEFITS

- Superior form-holding and lower-power requirements compared to premium competitive wheels
- Reduced frequency of dresses
- Decreased chances of burn and heat damage to the part

G-Force

- Unique bond technology
- Self-dressing
- Excellent depth of cut, traverse rates, and form holding

- Excels on round, carbide and steel tools
- Abrasive is strongly held – and wear-resistant
- Maintains a consistently sharp grinding edge
- Allows for lights-out manufacturing

- Reduces total grinding costs by 30% or more



NORTON/WINTER AND NORTON CNC WHEELS

GOOD CHOICE FOR SHORT RUNS AND FREQUENT GEOMETRY CHANGES

FEATURES

Norton/Winter

- A price competitive alternative to Paradigm, Univel, and G-Force wheels

BENEFITS

- Ideal for short-run manufacturing jobs where frequent wheel profile changes are required, and premium wheels can not be cost-justified
- Can be reshaped for numerous short runs
- Great performance/price ratio

Norton

- Ideal for reshaping and short-run manufacturing operations
- Free cutting phenolic specifications formulated for oil coolants
- Consistent wheel-to-wheel performance
- Precision tolerances

- Competitively-priced while providing premium performance
- Grind with less heat and pressure – eliminating burning
- Reduced cycle times, less dressing = longer wheel life
- Repeatable part geometry

Diamond CNC Wheels

BEST					NEW			BETTER			GOOD		
NORTON PARADIGM					NORTON G-FORCE/UNIVEL						NORTON/WINTER AND NORTON		
ABR. WIDTH U,W	ANGLE V	SPECIFICATION	ABR. DEPTH X	PART #	SPECIFICATION	ABR. DEPTH X	PART #	SPECIFICATION	ABR. DEPTH X	PART #			
TYPE 1A1 – Diamond Flute													
4 x 1/2 x 1-1/4		SD320-D168-P100C	3/8	07958783055*	AD320-UP061 G-Force	1/4	60157663909	A4D180-R115B610	1/4	69014118200			
								D220-C100-K+925	6mm	60157623605			
5 x 3/8 x 1-1/4		SD320-D168-P100C	1/2	07958783058*	AD320-UP061 G-Force	1/2	60157668409	A4D220-R115B610	1/2	69014118255			
								D220-C100-K+925	6mm	60157625123			
5 x 1/2 x 1-1/4		SD320-C176-P100C	1/2	07958783061	AD320-UP061 G-Force	1/2	60157662240	A4D180-R115B610	1/2	69014118202			
								D220-C100-K+925	6mm	60157613099			
5 x 5/8 x 1-1/4		SD320-C176-P100C	1/2	07958783063*	AD320-UP061 G-Force	1/2	60157663486*	A4D180-R115B610	1/2	69014118203*			
6 x 1/2 x 1-1/4		SD320-C176-P100C	1/2	07958783064	AD320-UP061 G-Force	1/4	60157682133*	A4D180-R115B610	1/4	69014118216*			
								D280-N100K+1421	6mm	60157624551			
TYPE 1A1 – Diamond Polish													
5 x 1/2 x 1-1/4					80D1000-100UP731 Univel	1/2	07958784316*						
TYPE 1A1 – Diamond Relief													
6 x 1/2 x 1-1/4		SD320-E168-P100C	1/2	07958783073*	AD320-UP892 G-Force	1/2	69014117684*	A4D180-R115B610	1/2	69014118217*			
								D280-N100-K+1421	6mm	60157624551			
TYPE 1A1RN – Diamond Flute													
5 x 3/8 x 1-1/4		SD320-D168-P100C	1/2	07958783067*	AD320-UP061 G-Force	1/2	60157663501	A4D180-R115B610	1/2	69014118201			
								D220-C100-K+925	6mm	60157625123			
5 x 1/2 x 1-1/4					AD220-UP061 G-Force	1/2	66260322280						
5 x 5/8 x 1-1/4					AD220-UP061 G-Force	1/2	60157664141						
TYPE 1B1 – Diamond Flute													
4 x 3/8 x 1-1/4		SD320-D168-P100C	3/8	07958783054									
	V=20°												
TYPE 1B1 – Diamond Flute/Gash													
5 x 3/8 x 1-1/4		SD320-E168-P100C	1/2	07958783065									
	V=45°												
TYPE 1B1 – Diamond Gash													
5 x 1/2 x 1-1/4		SD320-E168-P100C	1/4	07958783062*									
	V= 45°												
5 x 1/2 x 1-1/4		SD320-E168-P100C	1/4	07958783060*									
	V=60°												
5 x 1/2 x 1-1/4		SD320-E168-P100C	3/4	07958783070*				A4D320-R115B610	3/4	69014118207			
	V=30°							D220-C100-K+925	6mm	60157613112			
5 x 1/2 x 1-1/4		SD320-E168-P100C	3/4	07958783068*	AD320-UP531 G-Force	3/4	66260329603	A4D320-R115B610	3/4	69014118208			
	V=45°							D220-C100-K+925	6mm	60157623673			
TYPE 1V1 – Diamond Flute													
4 x 3/8 x 1-1/4					AD320-UP061 G-Force	1/4	66260316591	A4D180-R115B610	1/4	69014118263			
	V=20°												
5 x 1/2 x 1-1/4		SD320-C176-P100C	1/2	07958783071*	AD320-UP061 G-Force	1/2	66260116723	A4D180-R115B610	1/2	69014118204			
	V=10°												
5 x 1/2 x 1-1/4		SD320-C176-P100C	1/2	07958783074	AD320-UP061 G-Force	1/2	60157693843	A4D180-R115B610	1/2	69014118205			
	V=20°							D220-C100-K+925	6mm	60157623953			
5 x 1/2 x 1-1/4		SD320-C176-P100C	1/2	07958783085*	AD320-UP671 G-Force	1/2	60157693841	A4D180-R115B610	1/2	69014118206			
	V=30°												

* NON-STOCK: CONTACT YOUR NORTON REPRESENTATIVE FOR CURRENT LEAD-TIMES.
ALL HOLES (BORES) ARE MACHINED TO (H7) CLASS FIT.

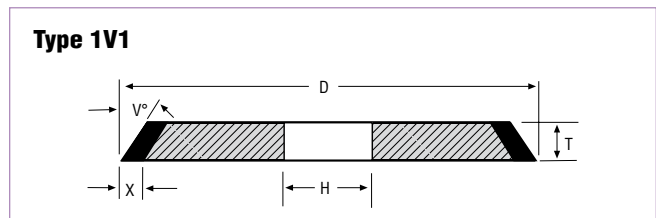
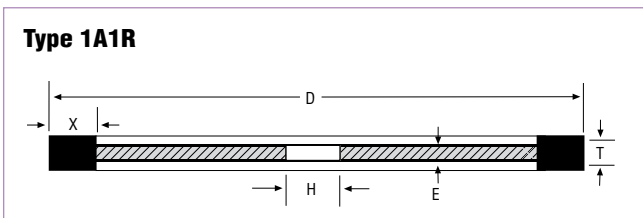
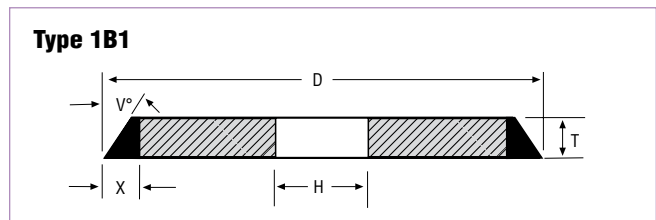
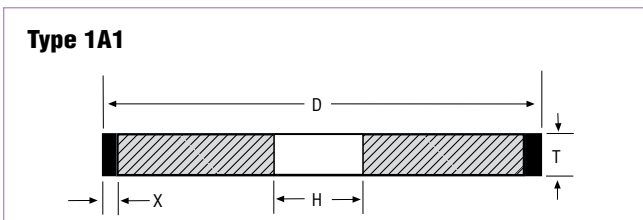

Diamond CNC Wheels

BEST				NEW			BETTER			GOOD		
NORTON PARADIGM							NORTON G-FORCE/UNIVEL			NORTON/WINTER AND NORTON		
ABR. WIDTH	ANGLE		ABR. DEPTH				ABR. DEPTH			ABR. DEPTH		
U,W	V	SPECIFICATION	X	PART #			X	PART #	SPECIFICATION	X	PART #	
TYPE 1V1 – Diamond Flute/Gash												
5 x 3/8 x 1-1/4	V=45°				AD320-UP531 G-Force	1/2	60157696562		A4D320-R115B610	1/2	69014118257	
TYPE 1V1 – Diamond Gash												
5 x 1/2 x 1-1/4	V=45°				AD320-UP531 G-Force	1/4	66260329604		A4D320-R115B610	1/4	69014118209	
5 x 1/2 x 1-1/4	V=60°				AD320-UR331 Univel	1/4	66260329469		A4D320-R115B610	1/4	69014118210	
TYPE 6A2 – Diamond Point												
4 x 1-1/4 x 1-1/4		SD320-E168-P100C	1/4	07958783057*	AD320-UP251 G-Force	1/4	69014118644*		ASD320C-R100B56	1/4	69014118219*	
W=1/4												
TYPE 11A2 – Diamond Relief												
3 x 1-1/4 x 1-1/4					10D320-NB100U Univel	1/4	60157692199					
W=1/4												
4 x 1-1/4 x 1-1/4		SD320-E168-P100C	1/4	07958783059*	AD320-UP701 G-Force	1/4	60157696315		ASDC320-R100B80	1/4	69014118213	
W=1/4												
4 x 1-1/4 x 1-1/4					AD320-UP561 G-Force	1/4	69014118479*		ASDC320-R100B80	1/4	69014118265*	
W=1/4												
TYPE 11V5 – Diamond Relief												
4 x 1-1/4 x 1-1/4	V=30°				AD320-UP561 G-Force	1/4	69014117838		ASDC320-R100B80	1/4	69014118211	
W=1/4												
4 x 1-1/4 x 1-1/4	V=10°				AD320-UP561 G-Force	1/4	69014117812		ASDC320-R100B80	1/4	69014118212	
W=3/8												
TYPE 11V9 – Diamond Relief												
3-3/4 x 1-1/2 x 1-1/4					10D240-PB125-U Univel	1/8	66260322134		ASDC320-R100B80	1/8	69014118259	
U=3/8												
5 x 1-3/4 x 1-1/4					10D240-PB125-U Univel	1/8	66260118300		ASDC320-R100B80	1/8	69014118215	
U=5/8									D280-R100-K+4821	3mm	60157612443	
TYPE 12V9 – Diamond Relief												
4 x 3/4 x 1-1/4					AD320-UP531 G-Force	1/8	66260127950*		ASDC320-R100B80	1/8	69014118221*	
U=3/8									D280-R100K+4821	3mm	60157612442	
5 x 3/4 x 1-1/4					AD320-UP531 G-Force	1/8	66260127911*		ASDC320-R100B80	1/8	69014118222*	
U=1/2												

* NON-STOCK; CONTACT YOUR NORTON REPRESENTATIVE FOR CURRENT LEAD-TIMES. ALL HOLES (BORES) ARE MACHINED TO (H7) CLASS FIT.

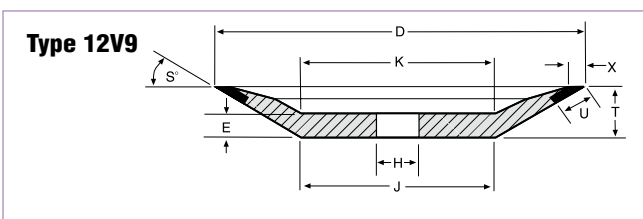
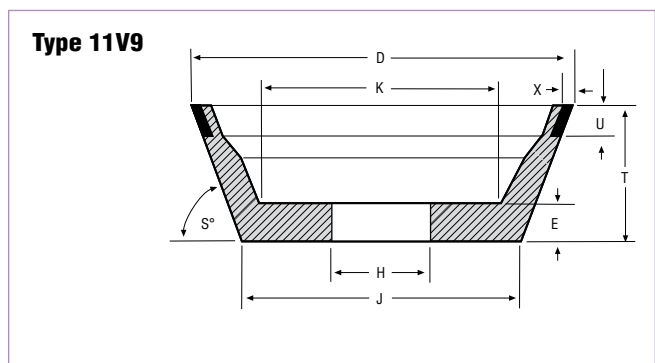
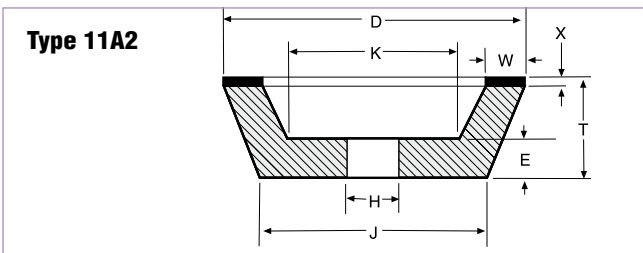
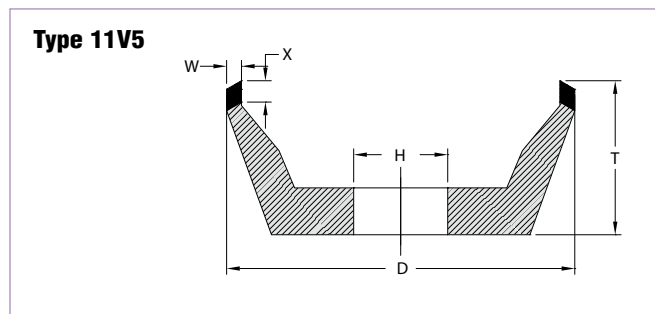
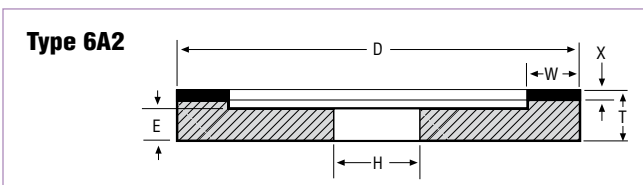

cBN CNC Wheels

		BEST			GOOD		
		NORTON G-FORCE/UNIVEL			NORTON/WINTER AND NORTON		
ABR. WIDTH U,W	ANGLE V	SPECIFICATION	ABR. DEPTH X	PART #	SPECIFICATION	ABR. DEPTH X	PART #
TYPE 1A1 – cBN Flute							
4 x 1/2 x 1-1/4		BX220-UP241 G-Force	1/4	60157669935*	BAM180-WBXD3037	1/4	69014118223*
					B220-V240-KSS920	6mm	60157623498
5 x 3/8 x 1-1/4		BX220-UP241 G-Force	1/2	69014118436*	BAM320C-WBXD3037	1/2	69014118256*
5 x 1/2 x 1-1/4		BX220-UP241 G-Force	1/2	60157670869*	BAM180-WBXD3037	1/2	69014118224*
					B220-V240-KSS920	6mm	60157602944
5 x 5/8 x 1-1/4		BX220-UP241 G-Force	1/2	66260329385*	BAM180-WBXD3037	1/2	69014118225*
6 x 1/4 x 1-1/4		BX240-UP241 G-Force	1/4	69014118435*	BAM180-WBXD3037	1/4	69014118240*
TYPE 1A1 – cBN Relief							
6 x 1/2 x 1-1/4		BX320-UP892 G-Force	1/2	69014117679*	BAM180-WBXD3037	1/2	69014118237*
TYPE 1A1RN – cBN Flute							
5 x 1/4 x 1-1/4		BX150-UP241 G-Force	1/2	07958773216*			
5 x 3/8 x 1-1/4		BX150-UP241 G-Force	1/2	07958773217*			
5 x 1/2 x 1-1/4		BX150-UP241 G-Force	1/2	69014141373*			
TYPE 1B1 – cBN Gash							
5 x 1/2 x 1-1/4	V=30°	BX320-UP701 G-Force	3/4	66260329388*	BAM320C-WBXD3037	3/4	69014118229*
5 x 1/2 x 1-1/4	V=45°	BX320-UP531 G-Force	3/4	66260329391*	BAM320C-WBXD3037	3/4	69014118230*
					B220-V240-KSS920	6mm	60157623542
TYPE 1V1 – cBN Flute							
4 x 3/8 x 1-1/4	V=20°	BX220-UP241 G-Force	1/4	69014118342*	BAM180C-WBXD3037	1/4	69014118264*
5 x 1/2 x 1-1/4	V=20°	BX220-UP241 G-Force	1/2	60157680042*	BAM180-WBXD3037	1/2	69014118227*
					B220-V240-KSS920	6mm	60157623944
5 x 1/2 x 1-1/4	V=30°	BX220-UP241 G-Force	1/2	60157691380*	BAM180-WBXD3037	1/2	69014118228*
5 x 1/2 x 1-1/4	V=10°	BX220-UP241 G-Force	1/2	66260119876*	BAM180-WBXD3037	1/2	69014118226*
TYPE 1V1 – cBN Flute/Gash							
5 x 3/8 x 1-1/4	V=45°	BX220-UP531 G-Force	1/2	60157697699*	BAM320C-WBXD3037	1/4	69014118262*
					B220-V240-KSS920	6mm	60157623524
TYPE 1V1 – cBN Gash							
5 x 1/2 x 1-1/4	V=60°	BX320-UR331 Univiel	1/4	66260329461*	BAM320C-WBXD3037	1/4	69014118232*
5 x 1/2 x 1-1/4	V=45°	BX320-UP531 G-Force	1/4	66260329275*	BAM320C-WBXD3037	1/4	69014118231*
					B220-V240-KSS920	6mm	60157623776
TYPE 6A2 – cBN Point							
4 x 1-1/4 x 1-1/4		BX320-UP241 G-Force	1/4	69014118543*	CB320C-WBB	1/4	69014118239*
W=1/4							
5 x 1-1/4 x 1-1/4		BX320-UP241 G-Force	1/4	69014118447*	CB320C-WBB	1/4	69014118238*
W=1/2							

* NON-STOCK: CONTACT YOUR NORTON REPRESENTATIVE FOR CURRENT LEAD-TIMES. ALL HOLES (BORES) ARE MACHINED TO (H7) CLASS FIT.

TECHtip

DIAMOND GRINDS:

In general, diamond is used to grind non-ferrous materials, because it reacts with iron.

- Cemented carbide
- Glass
- Ceramics
- Fiberglass
- Plastics
- Stone
- Abrasives
- Electronic components and materials

cBN GRINDS:

cBN is used to grind ferrous materials.

- High-speed tool steels
- Die steels
- Hardened carbon steels
- Alloy steels
- Aerospace alloys
- Hardened stainless steel
- Abrasion-resistant ferrous materials



It is the user's responsibility to refer to and comply with ANSI B7.1

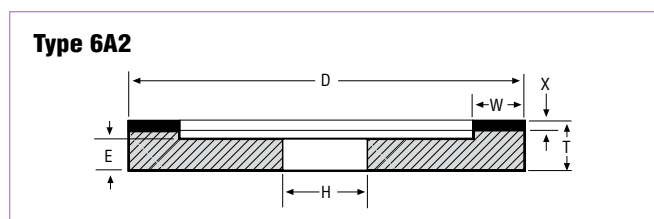
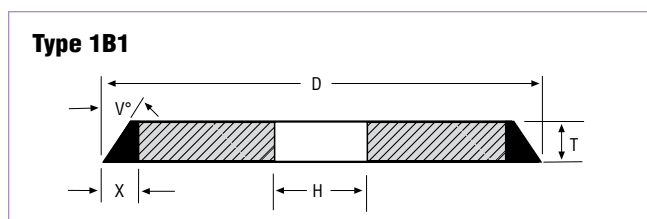
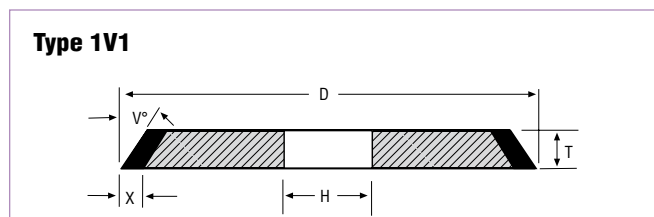
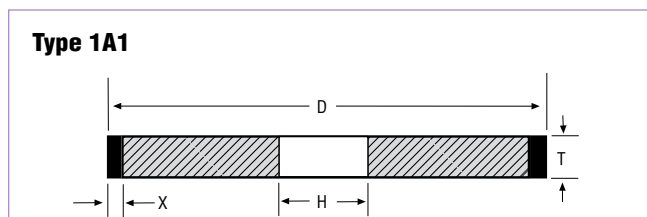

cBN CNC Wheels

		BEST			GOOD		
		NORTON G-FORCE/UNIVEL			NORTON/WINTER AND NORTON		
ABR. WIDTH U,W	ANGLE V	SPECIFICATION	ABR. DEPTH X	PART #	SPECIFICATION	ABR. DEPTH X	PART #
TYPE 11A2 – cBN Relief							
5 x 1-1/2 x 2 W=1/4		BX320-UP531 G-Force	1/4	69014118406*	BAM220-WBE	1/4	69014118254*
TYPE 11A2 – cBN Relief							
4 x 1-1/4 x 1-1/4 W=1/4		BX320-UP531 G-Force	1/4	69014118445*	BAM220-WBE	1/4	69014118266*
TYPE 11V5 – cBN Relief							
4 x 1-1/4 x 1-1/4 W=1/4	V=30°	BX320-UP701 G-Force	1/4	69014117833*	BAM220-WBE	1/4	69014118233*
4 x 1-1/4 x 1-1/4 W=3/8	V=10°	BX320-UP701 G-Force	1/4	69014117820*	B220-J240-KSS63Y	6mm	60157623563
TYPE 11V9 – cBN Relief							
3-3/4 x 1-1/2 x 1-1/4 U=3/8		90B240-PB125-U Univel	1/8	69014118345*	BAM220-WBE	1/8	69014118260*
TYPE 11V9 – cBN Relief							
3-3/4 x 1-1/2 x 1-1/4 U=3/8		90B240-PB125-U Univel	1/8	69014118029*	BAM220-WBE	1/8	69014118235*
5 x 1-3/4 x 2 U=3/8		90B240-PB125-U Univel	1/8	69014118043*	BAM220-WBE	1/8	69014118248*
TYPE 12V9 – cBN Relief							
4 x 3/4 x 1-1/4 U=3/8		BX320-UP531 G-Force	1/8	69014118470*	BAM220-WBE	1/8	69014118241*
5 x 3/4 x 1-1/4 U=1/2		BX320-UP531 G-Force	1/8	69014118441*	BAM220-WBE	1/8	69014118242*

* NON-STOCK: CONTACT YOUR NORTON REPRESENTATIVE FOR CURRENT LEAD-TIMES.
ALL HOLES (BORES) ARE MACHINED TO (H7) CLASS FIT.

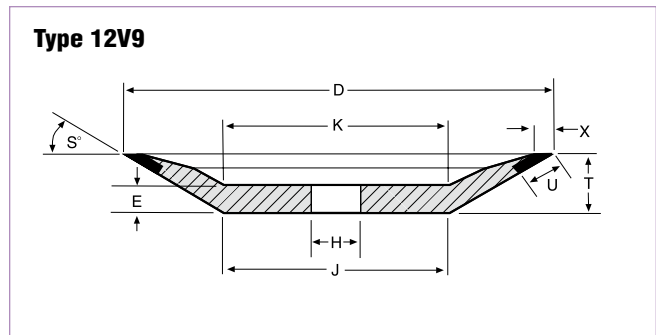
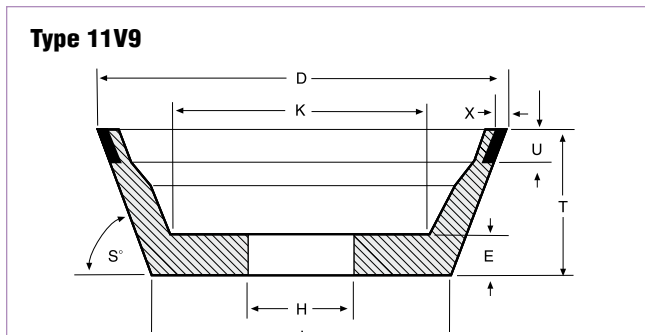
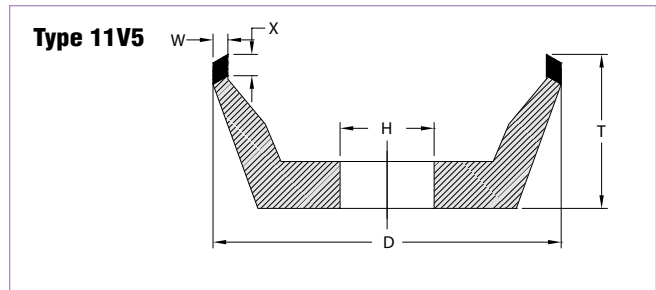
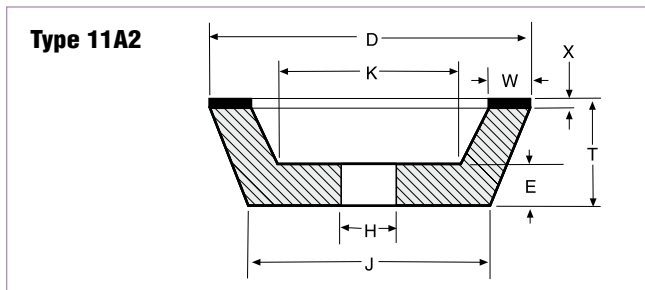

Norton CNC Express Made-To-Order Wheels

Blank Stock Inventory to be altered to your specifications within 5-10 days

Wheel Shape	Tool Material	Application	G-Force Specification AD = Diamond BX = cBN	Diameter D	THK. T	Hole H	Abr. Depth X	Angle (V) or Radius (R)									
	WC	Fluting	AD320-UP061E	5	7/16" min. to 1/2" max.	1/2" min. to 2" max.	1/2"	-									
	HSS	Fluting	BX320-UP241E	5													
	WC	Fluting	AD320-UP061E	6													
	WC	Fluting	AD320-UP061E	5				7/16" min. to 1/2" max.	1/2" min. to 2" max.	1/2"	1 deg. - 30 deg.						
	WC	Fluting	AD320-UP061E	6													
	HSS	Fluting	BX320-UP241E	5													
	WC	Gashing	AD320-UP531E	5							7/16" min. to 1/2" max.	1/2" min. to 2" max.	1/2"	1 deg. - 55 deg.			
	HSS	Gashing	BX320-UP531E	5													
	WC	Fluting	AD320-UP061E	5										7/16" min. to 1/2" max.	1/2" min. to 2" max.	1/2"	90 deg. to 178 deg.
	HSS	Fluting	BX320-UP241E	5													
	WC	Fluting	AD320-UP061E	6													
	WC	Fluting	AD320-UP061E	5													7/16" min. to 1/2" max.
	HSS	Fluting	BX320-UP241E	5													
	WC	Fluting	AD320-UP061E	6													
	WC	Fluting	AD320-UP061E	5	7/16" min. to 1/2" max.	1/2" min. to 2" max.	1/2"										
	HSS	Fluting	BX320-UP241E	5													
	WC	Fluting	AD320-UP061E	6													
	WC	Fluting	AD320-UP061E	5				7/16" min. to 1/2" max.	1/2" min. to 2" max.	1/2"							
	HSS	Fluting	BX320-UP241E	5													
	WC	Fluting	AD320-UP061E	6													

NOTE: ALL OF THE WHEEL SHAPES LISTED CAN ALSO BE DESIGNATED TO HAVE .010 RELIEF(S) 1 SIDE, OR 2 SIDES ON 1A1P AND 1A1RN WHEELS.

CNC EXPRESS WHEEL SERVICE FOR WC AND HSS TOOLS

- G-Force Diamond and cBN wheels altered from blank stock
- Available for a large range of special geometries
- 2-week standard lead time for first-time orders (new part numbers)
- 1-week lead-time for repeat orders (existing part numbers)

HOW TO REQUEST AN EXPRESS WHEEL QUOTE AND ORDER

Refer to this chart and choose:

- Wheel shape by application
- Diameter "D"
- Thickness "T" from the range of 7/16" to 1/2"
- Hole "H" from the range of 1/2" to 2"
- Angle ("V"), Radius ("R") dimensions from the range provided
- Abrasive depth "X" will always be 1/2" for these CNC wheels
- Specifications required for material and application
- NOTE: Please remember to include the "E" at the end of the specification to indicate Express lead-time is required



CATEGORY DEFINITION

Brake Controlled Truing Devices

Designed for truing diamond and cBN wheels rapidly, effectively, and with a minimum of superabrasive loss. Recommended for wheels up to 12" in diameter.

- APPLICATIONS:**
- Truing straight, cup and cylinder wheels:
 - Straight wheels, used on chip breaker, tool and cutter, surface, and cylindrical grinding machines
 - Cup wheels, used on vertical spindle surface grinders
 - Internal grinding wheels
 - Cut-off wheels

Stock 4597 Brake Controlled Truing Device

The 4597 is engineered for heavier and more frequent truing applications. The adjustable speeds allow for varying conditions (between 1050 and 1500 SFPM). It comes complete with a reusable case, "True to Form, Dress to Cut" training video, two 3" 38A60-M8VBE* vitrified wheels, Truing Device Tips book and a dressing stick. It can be rebuilt using the 4597RK Rebuild Kit.

Worn #4597 Brake Controlled Truing Devices (UPC 66260195350) in need of reconditioning (beyond new shoes and springs) may be returned to be rebuilt. Contact Customer Service for return instructions and quote.

Stock 3597 Pacesetter Brake Controlled Truing Device

The Pacesetter model is ideal for light-duty use. The pre-set brake speed requires no adjusting. This model includes one 3" 38A60-M8VBE* vitrified wheel and can be rebuilt using the 3597RK Rebuild Kit.

Stock 4597RK and 3597RK Rebuild Kits

The truing devices can be rebuilt with these kits, consisting of 3 brake shoes, 3 springs, and 3 screws.

ITEM	BETTER		GOOD	
	PRODUCT NO.	PART #	PRODUCT NO.	PART #
Truing Devices				
4597 Brake Controlled Truing Device	4597	66260195350		
3597 Pacesetter Brake-Controlled Truing Device	3597	66260135578		
Truing Device Rebuild Kits				
4597 Rebuild Kit	4597RK	66260195351		
3597 Pacesetter Rebuild Kit	3597RK	66260135595		
Replacement Wheels				
3 x 1 x 1/2			38A60-MVBE	66243529145
			38A80-MVBE	66243529146
			37C60-MVK	66243529166
			37C80-HVK	66243529170
			37C80-MVK	66243529171
			37C100-HVK	66243529172
			37C100-MVK	66243529070

SPECcheck

TRUING DIAMOND AND CBN WHEELS

SUPERABRASIVE WHEEL	TRUING WHEEL SPECIFICATION
RESIN AND VITRIFIED BOND	
80, 100, and 120 grits	38A60-MVBE, 37C60-MVK
150, 180, and 220 grits	38A80-MVBE, 37C80-MVK
320 and finer grits	37C100-HVK
METAL BOND	
80, 100, and 120 grits	38A60-MVBE
150, 180, and 220 grits	38A80-MVBE
240 and finer grits	37C80-HVK

TECHtip

- Prior to truing the wheel, run a wax crayon over the wheel face. Important: do NOT use any liquid-based ink on superabrasive wheels.
- Any crayon left on the wheel face after truing will reveal untrued areas.
- Indicate the superabrasive wheel runout before starting... usually within .001" to .002", to minimize wheel loss.
- Mount the device spindle parallel to the wheel spindle to ensure proper straight face truing.
- For cup-shaped wheels, the device spindle will be mounted perpendicular to the wheel spindle.
- Always use the brake-controlled truing device dry.
- Bring the diamond/cBN wheel and the truing wheel together until they almost touch.
- Start the diamond/cBN wheel to normal speed; spin the truing wheel in the same direction at point of contact.
- Bring the two wheels together until they touch.
- Make sure the truing wheel is spinning at time of contact.
- Traverse the wheel back and forth at 30 to 60 inches/minute.
- Downfeed .0005" to .001" at the end of each traverse.
- At the end of truing, the diamond/cBN wheel should be smooth and in truth.
- Apply a dressing stick to sharpen the wheel.

! It is the user's responsibility to refer to and comply with ANSI B7.1

Diamond and cBN Wheel Mounting, Truing and Dressing Guide

To achieve the best results using Norton diamond and cBN products, the following steps for mounting, truing and dressing should be practiced:

MOUNTING – Putting Wheel on Machine Spindle

- Examine wheel flanges and spindle carefully.
- Be sure flanges' surfaces are clean and free of damage.
- Ensure that the mounting flanges are flat and of equal diameter, especially on wheels with rigid centers, such as vitrified bond wheels.
- Paper or plastic blotters should only be used when mounting superabrasive wheels with vitrified cores. Using paper or plastic blotters on any other core material may result in the wheel loosening during grinding.
- Inspect machine spindle for excessive runout.
 - TIR (Total Indicated Runout) should be no greater than 0.0002".
- Mount wheel between hand-tightened flanges.
- Using a dial indicator, tap the wheel lightly with a rubber or wooden block to minimize runout to less than .0010".
- Tighten flange securely and recheck with indicator.
- Allow a newly mounted wheel to operate for one full minute before grinding.
- The use of one permanent mounting for the life of the wheel is recommended whenever possible:
 - If the grinding machine has a tapered spindle, mount each straight, flaring cup or dish wheel on a separate collet or adapter.
 - When changing wheels the entire unit is removed, keeping the wheel in running truth.
 - When needed again, the entire unit can be placed directly on the spindle or arbor, thereby eliminating the time and abrasive lost in retruing.

TRUING – Making Wheel Round and Concentric with the Spindle Axis

- Prior to truing the wheel, run a wax crayon over the wheel face. Important: do not use any liquid-based ink on superabrasive wheels.
- Any crayon left on the wheel face after truing will reveal untrued areas.
- Indicate the superabrasive wheel runout before starting... usually within .001" to .002", to minimize wheel loss.
- Norton brake controlled truing devices are most commonly used to true Diamond and cBN straight, cup and cylinder wheels.
 - Mount the device spindle parallel to the wheel spindle to ensure proper straight face truing.
 - For cup wheels, the device spindle will be mounted perpendicular to the wheel spindle.
 - Always use brake controlled truing device dry.
 - Bring the diamond/cBN wheel and the truing wheel together until they almost touch.
- Start the diamond/cBN wheel to normal speed; start the truing wheel in the same direction.
- Bring the two wheels together until they touch.
- Make sure the truing wheel is spinning at time of contact.
- Traverse the wheel back and forth at 30 to 60 inches per minute.
- Downfeed .0005" to .001" at the end of each traverse.
- At the end of truing, the diamond/cBN wheel should be smooth and in truth.
- Apply a dressing stick to sharpen the truing wheel.

DRESSING – Opening the Face of a Trued Wheel

- Dressing the abrasive – a cleaning/sharpening process to expose sharp, free-cutting grit:
 - For resinoid and vitrified bond wheels, the dressing stick should be one or two grit sizes finer than the abrasive in the diamond/cBN wheel – in a soft grade such as H or I.
 - For metal bond wheels, choose a stick with the same grit or one grit coarser than the wheel abrasive – in a medium grade (K – N).
 - See the "Dressing Stick" section for recommendations.
- Dressing the core – The core material (the part of the wheel that holds and supports the abrasive-bearing section) should never contact the work piece during grinding; rubbing will generate excessive heat. As the abrasive section of a cup wheel wears, the core material might become exposed, necessitating dressing.
 - Use a single-point carbide or steel tool to dress an exposed resalloy core.
 - Clamp the tool in a vise.
 - Direct the cutting edge accurately to leave a 1/16" of abrasive section exposed.



Properly Dressed Wheel Face

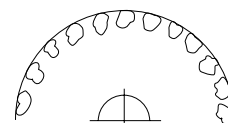

AFTER TRUING
THE WHEEL FACE IS SMOOTH
AND CLOSED

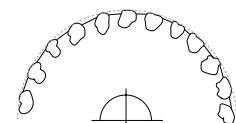

AFTER DRESSING
THE WHEEL FACE IS OPEN WITH THE
GRITS EXPOSED, READY FOR
EFFICIENT GRINDING ACTION

AFTER DRESSING cBN GRIT



TAIL
(BOND SUPPORTING GRIT)

AFTER DRESSING

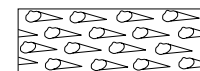

PATH CONNECTING THE TAILS FOR
COOLANT AND CHIP FLOW



CATEGORY DEFINITION

Regular use of properly selected dressing sticks will help you achieve maximum performance from your grinding wheels.

- APPLICATIONS:** Truing, cleaning, and dressing diamond, cBN, and conventional abrasive grinding wheels
- SIZE RANGE:** Thickness/Width/Diameter: 1/4" – 1"
Length: 3" – 8"
- GRIT RANGE:** 16 – 400
- ABRASIVE GRAIN:** Aluminum Oxide, Boron Nitride, Silicon Carbide
- SHAPE:** Square, rectangular, and round

GRINDING WHEEL-TO-PRODUCT RECOMMENDATION GUIDE

Selecting the appropriate dressing stick for each application depends on the wheel size, type, speed, specification, and grit size, as well as the workpiece material. Initial starting specifications are listed below. We recommend testing several sticks to find the best one for your application.

VITRIFIED DRESSING STICKS		
	Product	Specification
Superabrasive Wheels - Resin and Vitrified Bond		
- 80, 100, and 120 grits	Dressing Stick	38A150-HVBE
- 150, 180, and 220 grits	Dressing Stick	38A220-HVBE
- 320 and finer grits	Superfine Stick	NMVC400-J5VCA
Superabrasive Wheels - Metal Bond		
- 80, 100, and 120 grits	Dressing Stick	37C80-NV
- 150, 180, and 220 grits	Dressing Stick	37C150-KV
- 240 and finer grits	Dressing Stick	37C220-KV
Conventional Vitrified Wheels - Vitrified Bond		
- 46 grit and finer and M grade and softer	High Performance Dressing Stick	Norbide
	Conventional Dressing Stick	37C24-SVK



Norbide High Performance Sticks

For offhand truing and dressing of medium grit, soft- and medium-grade vitrified grinding wheels. Norton Norbide sticks are the hardest sticks you can buy. Made from boron nitride, they are well suited for dressing tool and cutter wheels 10" and smaller, especially cup and saucer shapes.

AVAILABILITY

		TIER: BETTER	
		BRAND: Norton	
SIZE (T x W x L*)	STD. PKG.	SPEC.	PART #
High Performance Long Life Stick			
1/4 x 1/2 x 3	5	Norbide	61463610148
* THICKNESS X WIDTH X LENGTH			

TECHtip

DRESSING DIAMOND AND CBN WHEELS

- Resin and Vitrified Bond Diamond, and cBN Wheels
 - Choose a dressing stick one or two grit sizes finer than the abrasive in the wheel – in a soft grade (H or I).
- Metal Bond Diamond, and cBN Wheels
 - Choose a stick the same grit size or one grit size coarser than the abrasive in the wheel – in a medium grade (K–M).

! It is the user's responsibility to refer to and comply with ANSI B7.1
PanAmericanDistribution.com



Vitrified Dressing Sticks

Aluminum Oxide (White)

For dressing and cleaning cBN wheels; these sticks also work well for diamond wheels.

Silicon Carbide (Black)

Coarse grit (16 - 46) and hard-grade (R and harder) sticks are used for dressing conventional vitrified wheels. Finer grit and softer grades are used for dressing diamond wheels.

AVAILABILITY

TIER: **BETTER**
BRAND: Norton

SIZE (T x W x L)	STD. PKG.	SPEC.	PART #
Vitrified Dressing Sticks – Aluminum Oxide			
3/8 x 3/4 x 4	5	38A150-IVBE	61463639635
1/2 x 1/2 x 4	5	38A220-HVBE	61463610555
1/2 x 1/2 x 6	5	38A150-IVBE	61463610303
	5	38A220-HVBE	61463610103
1/2 x 3/4 x 4	5	38A60-LVBE	61463610415
3/4 x 3/4 x 4	5	38A60-LVBE	61463610440
	5	38A80-MVBE	61463610362
	5	38A90-LV	61463639632
	5	38A150-HVBE	61463610291
	5	38A150-IVBE	61463610368
	5	38A220-HVBE	61463610290
	5	38A220-HVBE	61463610280
	5	38A150-HVBE	61463610405
1 x 1 x 6	5	38A150-IVBE	61463610453
	5	38A220-HVBE	61463610406
	5	38A120-IVBE	61463610390
1 x 1 x 8	5	38A150-IVBE	61463610455

AVAILABILITY

TIER: **BETTER**
BRAND: Norton

SIZE (T x W x L)	STD. PKG.	SPEC.	PART #
Vitrified Dressing Sticks – Silicon Carbide			
1/2 x 1/2 x 6	5	37C24-SVK	61463610285
	5	37C100-LV	61463610201
	5	37C150-KV	61463610205
	5	37C150-LV	61463610206
	5	37C150-MV	61463610207
	5	37C220-KV	61463610214
3/4 x 3/4 x 6	5	37C150-LV	61463610375
	5	37C20-SVK	61463610459
1 x 1 x 6	5	37C24-SVK	61463610462
	5	37C24-TVK	61463610354
	5	37C46-RVK	61463610466
	5	37C80-NV	61463610393
	5	37C150-KV	61463610438
	5	37C220-KV	61463610398
	5	S/C Medium Grit	07660710466
	5	37C20-SVK	61463610469
1 x 1 x 8	5	37C24-SVK	61463610471
	5	37C16-TVK	61463610482
2 x 2 x 8	5	37C24-TVK	61463610485
	5	37C24-SVK	61463610490
Vitrified Round Dressing Sticks – Silicon Carbide			
1/2 x 6	5	37C24-SVK	61463610371
1 x 6	5	S/C Ex-C (JT276)	61463687905

Vitrified Superfine Sticks

For dressing superabrasive wheels.

AVAILABILITY

TIER: **BETTER**
BRAND: Norton

SIZE (T x W x L)	STD. PKG.	SPEC.	PART #
Vitrified Superfine Sticks – Aluminum Oxide			
1 x 1 x 6	5	PCD Coarse - 400 grit	61463647865
	5	PCD Fine - 800 grit	61463647867
1 x 1 x 8	5	NSA320-H8V	61463610597
Vitrified Superfine Sticks – Silicon Carbide			
1/2 x 1/2 x 6	5	NMVC320-J5VCA	61463610599
	5	NMVC400-J5VCA	61463650324
1 x 1 x 6	5	NMVC320-J5VCA	61463610605
	5	NMVC400-J5VCA	61463650450

Offhand Grinding Wheel Dressing Stick and Holder

This convenient metal holder is widely used by mechanics and foundry-men for truing, dressing and changing the face of the wheel. The JT246 dressing stick – an extra coarse grit silicon carbide for dressing conventional vitrified wheels – is firmly held and adjusted by the knurled control.



AVAILABILITY

TIER: **BETTER**
BRAND: Norton

SIZE (D x L)	SPEC.	MIN./STD. PKG.	PRODUCT #	PART #
Offhand Grinding Wheel Dressing Stick and Holder				
1/2 x 6 Round	Silicon Carbide Extra Coarse Grit Round Dressing Stick	5/10	JT246	61463687900
10 Overall	Dressing Stick Holder	5/10	H6	61463687895



Rubber Finishing Sticks

These sticks are used for manual or mechanical honing on machines where they are mounted in holders or fixtures. Intended for use where precision dimensional limits and grade controls are required, such as die polishing.

AVAILABILITY

TIER:

BETTER

BRAND:

Norton

SIZE (T x W x L)	MIN./STD. PKG.	SPEC.	PART #
Rubber Finishing Sticks			
1/2 x 1/2 x 6	5/20	57A120-B2RR	61463610608
1/2 x 1 x 6	5/20	57A120-B2RR	61463610609

Blank Stock FastTrack Made-to-Order Microabrasive Superfinishing Sticks



Superfinishing blank stock encompasses a wide range of different specifications. These blanks can be finished to your dimensional requirements within two weeks from the date that the order is received at Norton Customer Service. Small lots, for test purposes, can be express shipped.

APPLICATIONS	ABRASIVE TYPE – BOND	GRIT RANGE	TREATMENT TYPE
Superfinishing / Finishing and Dressing	NLA – V	240 – 1200	Sulfur, Wax
	NMVC – VCA		
Honing	NSA – V	54 – 220	
	SG – VS		
	SGG – VS1		



CATEGORY DEFINITION

Our extensive offering of stock diamond and cBN electroplated products has been engineered to meet the diverse demands of traditional and emerging tool and die, ceramic, and composite applications.

APPLICATIONS: Small hole/ID grinding, deburring, cleaning, honing, precision drilling, forming dies and molds, routing, reaming, blending radii, notching and cutting-off with saw blades in ceramic, tool and die, and composite applications

PRODUCTS: Mounted points, mandrels, drills, routers, contour tools, wheels, files, and saw blades

ABRASIVE GRAIN: Diamond and cBN (cubic Boron Nitride)

Abrasive Applications

Although diamond and cBN (cubic Boron Nitride) are both superabrasives, the use of diamond and cBN varies, depending upon the materials to be ground.

Diamond Grinds:

- Cemented carbide
- Glass
- Ceramics
- Fiberglass
- Plastics
- Composites
- Abrasives
- Stone
- Electronic components and materials

cBN Grinds:

- High-speed tool steels
- Die steel
- Hardened carbon steels
- Hardened stainless steels
- Alloy steels
- Aerospace alloys
- Abrasion-resistant ferrous materials

In general, cBN is used to grind ferrous materials. Diamond is used to grind non-ferrous materials, because of an adverse reaction between diamond and iron.

TECHtip

COOLANTS

Although coolants may not be necessary, using a coolant produces superior surface finishes, a longer tool life, higher performance, and reduces tool loading.

FEEDS

Suggested feeds for jig or internal grinding are from .0002" – .0004" per pass.

SPEEDS

Maximum Operating Speeds (MOS)

Never exceed the maximum operating speed marked on the superabrasive product being used.

Electroplated Products: 25,000 SFPM

Maximum speeds of mounted points are a function of the length of overhang and size of the product. Refer to "Safe Operating Speeds" in form #2872, provided with your product.

Recommended Operating Speeds

The preceding speed is the maximum safe speed and not necessarily the most efficient. Superabrasive products operate most effectively at speeds lower than the maximum. The following are general recommendations. cBN products, in many cases, are used effectively at higher speeds.

Electroplated Diamond Products: 5,000 to 10,000 SFPM

Electroplated cBN Products: 8,000 to 10,000 SFPM

Calculating Operating Speed

The following formula may be used to quickly calculate wheel speed: RPM = Revolutions Per Minute
SFPM = Surface Feet Per Minute

To convert SFPM to RPM: (Multiply SFPM x 3.82) divided by wheel diameter in inches

Made-to-Order Electroplated Product Guide

The stock electroplated products offered on the following pages have been engineered to meet the diversity of demands typical in today's manufacturing environment.

When special forms, shapes, and configurations are required, Norton electroplated diamond and cBN products can be fabricated in almost any geometry.

Customer-Supplied Preforms and Blanks

Customers may prefer to manufacture their own preforms/blanks for custom products and in many cases this can reduce cost and lead-times. The instructions below detail the necessary allowances for each grit size. Please refer to these whenever manufacturing blanks.

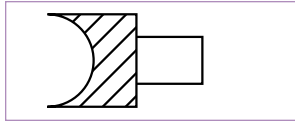

Area to be plated (female radius)

Female radius must be larger than the finished size required.

Example – If a .500 female radius is required with 60/80 grit, then the blank should be manufactured .011 larger = .511

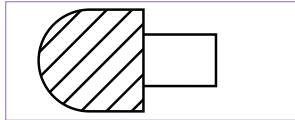

Area to be plated (male radius)

A male radius must be smaller than the finished size required.

Example – If a .500 male radius is required with 60/80 grit, then the blank should be manufactured .011 smaller = .489

Grit Size Allowance for Plated Products

ALLOWANCE/GRIT SIZE	PARTICLE SIZE
20/30	.035
30/40	.025
40/50	.018
60/80	.011
80/100	.008
100/120	.007
120/140	.006
140/170	.005
170/200	.004
200/230	.0035
270/325	.003
4.5 Micron – 400	.0025
30 Micron – 600	.0016
15 Micron – 1200	.001

THIS SHOULD BE USED AS A GUIDE WHEN MANUFACTURING BLANKS TO BE PLATED WITH DIAMOND OR CBN.

Surface Finish

Use this chart only as a guide. Surface finish is affected by a number of variables: machine type and condition, type of material, coolant, wheel speed, bond system, etc.

Expected RMS Finish

GRIT SIZE	ELECTROPLATED
80	90-125
100	64-90
120	48-64
150	32-48
180	24-32
220	20-24
240	16-20
320	16-20
400	14-20
500	12-13
600	12

Strip and Replate Services

Ask Customer Service for information and quotations on our complete strip and replat services on many electroplated products.



Electroplated Mounted Points

DIAMOND AND cBN MOUNTED POINTS ● ▲

FEATURES	BENEFITS
■ Nickel alloy matrix	■ Tough, durable bond
■ Single layer of abrasive	■ Economical
■ Exposed particles	■ Aggressive cutting action
■ Variety of tools and grit sizes available as stock	■ Satisfy most tool and die and deburring requirements
■ Mandrels are made of high-speed tool steel	■ Withstand operating pressure

Use Norton diamond mounted points for precise, small hole, jig and internal grinding of carbide, ceramics, sapphire, glass, and a variety of tough, super alloys.

For grinding tough, high carbon, high chrome steel, use cBN mounted points.

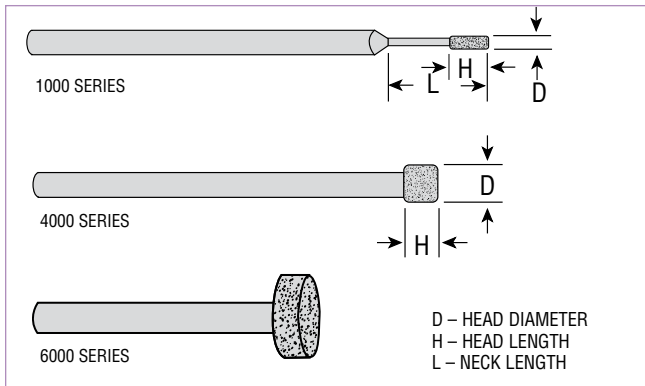

PART #	PRODUCT #	HEAD DIAMETER INCHES	HEAD LENGTH	NECK LENGTH	GRIT SIZE
1000 Series – Diamond					
1/8" Shank x 2-1/4" Overall Length					
66260392429	1016FD	.016	.079	1/8	200
66260392432	1020MD	.020	.079	1/8	150
66260392431	1020FD	.020	.079	1/8	200
66260392436	1025MD	.025	.079	1/8	150
66260392435	1025FD	.025	.079	1/8	200
66260392440	1030MD	.030	.079	1/4	150
66260392439	1030FD	.030	.079	1/4	200
66260392445	1035CD	.035	.118	1/4	100
66260392444	1035MD	.035	.118	1/4	150
66260392443	1035FD	.035	.118	1/4	200
66260392451	1040CD	.040	.118	1/4	100
66260392450	1040MD	.040	.118	1/4	150
66260392449	1040FD	.040	.118	1/4	200
66260392457	1045CD	.045	.118	1/4	100
66260392456	1045MD	.045	.118	1/4	150
66260392455	1045FD	.045	.118	1/4	200
66260392463	1050CD	.050	.118	1/2	100
66260392462	1050MD	.050	.118	1/2	150
66260392461	1050FD	.050	.118	1/2	200
66260392469	1050LCD	.050	.118	1	100
66260392468	1050LMD	.050	.118	1	150
66260392467	1050LFD	.050	.118	1	200
66260392475	1055CD	.055	.118	1/2	100
66260392474	1055MD	.055	.118	1/2	150
66260392473	1055FD	.055	.118	1/2	200
66260392481	1060CD	.060	.157	1/2	100
66260392480	1060MD	.060	.157	1/2	150
66260392479	1060FD	.060	.157	1/2	200
66260392487	1060LCD	.060	.157	1	100

CONTINUED

PART #	PRODUCT #	HEAD DIAMETER INCHES	HEAD LENGTH	NECK LENGTH	GRIT SIZE
1000 Series – Diamond (continued)					
1/8" Shank x 2-1/4" Overall Length					
66260392492	1065MD	.065	.157	1/2	150
66260392491	1065FD	.065	.157	1/2	200
66260392499	1070CD	.070	.157	1/2	100
66260392488	1070MD	.070	.157	1/2	150
66260392497	1070FD	.070	.157	1/2	200
66260392511	1075CD	.075	.157	1/2	100
66260392510	1075MD	.075	.157	1/2	150
66260392509	1075FD	.075	.157	1/2	200
66260392517	1080CD	.080	.157	1/2	100
66260392516	1080MD	.080	.157	1/2	150
66260392515	1080FD	.080	.157	1/2	200
66260392523	1080LCD	.080	.157	1	100
66260392521	1080LFD	.080	.157	1	200
66260392529	1085CD	.085	.157	1/2	100
66260392528	1085MD	.085	.157	1/2	150
66260392535	1090CD	.090	.157	1/2	100
66260392534	1090MD	.090	.157	1/2	150
66260392533	1090FD	.090	.157	1/2	200
66260392541	1090LCD	.090	.157	1	100
66260392540	1090LMD	.090	.157	1	150
66260392547	1095CD	.095	.157	1/2	100
66260392546	1095MD	.095	.157	1/2	150
66260392553	1100CD	.100	.157	1/2	100
66260392552	1100MD	.100	.157	1/2	150
66260392551	1100FD	.100	.157	1/2	200
66260392565	1105CD	.105	.157	1/2	100
66260392563	1105FD	.105	.157	1/2	200
66260392577	1110CD	.110	.157	1/2	100
66260392576	1110MD	.110	.157	1/2	150
66260392583	1110LCD	.110	.157	1	100
66260392589	1115CD	.115	.157	1/2	100
66260392588	1115MD	.115	.157	1/2	150
66260392595	1120CD	.120	.157	1/2	100
66260392594	1120MD	.120	.157	1/2	150
66260392593	1120FD	.120	.157	1/2	200
66260392601	1125CD	.125	.157	1/2	100
66260392600	1125MD	.125	.157	1/2	150
66260392599	1125FD	.125	.157	1/2	200
66260392607	1130CD	.130	.197	1	100
66260392606	1130MD	.130	.197	1	150
66260392613	1135CD	.135	.236	N/A	100
66260392612	1135MD	.135	.236	N/A	150
66260392611	1135FD	.135	.236	N/A	200
66260392619	1140CD	.140	.236	N/A	100
66260392625	1156CD	.156	.236	N/A	100
66260392624	1156MD	.156	.236	N/A	150
66260392623	1156FD	.156	.236	N/A	200
66260392730	1171MD	.171	.236	N/A	150

CONTINUED

TARGET MARKET SYMBOLS		
● = CERAMICS	▲ = TOOL & DIE	■ = COMPOSITES

Electroplated Mounted Points

DIAMOND AND cBN MOUNTED POINTS ● ▲

PART #	PRODUCT #	HEAD DIAMETER INCHES	HEAD LENGTH	NECK LENGTH	GRIT SIZE
1000 Series – Diamond (continued)					
1/8" Shank x 2-1/4" Overall Length					
66260392730	1171MD	.171	.236	N/A	150
66260392737	1187CD	.187	.312	N/A	100
66260392735	1187FD	.187	.312	N/A	200
66260392742	1203MD	.203	.312	N/A	150
66260392741	1203FD	.203	.312	N/A	200
66260392748	1218MD	.218	.312	N/A	150
66260392747	1218FD	.218	.312	N/A	200
66260392755	1250CD	.250	.312	N/A	100
66260392754	1250MD	.250	.312	N/A	150
66260392753	1250FD	.250	.312	N/A	200
66260363450	1750MD	.750	.035	N/A	150
1000 Series – cBN					
1/8" Shank x 2-1/4" Overall Length					
66260392434	1020MC	.020	.079	1/8	150
66260392442	1030MC	.030	.079	1/4	150
66260392453	1040MC	.040	.118	1/4	150
66260392460	1045CC	.045	.118	1/4	100
66260392466	1050CC	.050	.118	1/2	100
66260392465	1050MC	.050	.118	1/2	150
66260392464	1050FC	.050	.118	1/2	200
66260392484	1060CC	.060	.157	1/2	100
66260392483	1060MC	.060	.157	1/2	150
66260392482	1060FC	.060	.157	1/2	200
66260392496	1065CC	.065	.157	1/2	100
66260392502	1070CC	.070	.157	1/2	100
66260392501	1070MC	.070	.157	1/2	150
66260392500	1070FC	.070	.157	1/2	200
66260392514	1075CC	.075	.157	1/2	100
66260392512	1075FC	.075	.157	1/2	200
66260392520	1080CC	.080	.157	1/2	100
66260392532	1085CC	.085	.157	1/2	100
66260392531	1085MC	.085	.157	1/2	150
66260392538	1090CC	.090	.157	1/2	100
66260392537	1090MC	.090	.157	1/2	150
66260392536	1090FC	.090	.157	1/2	200
66260392544	1090LCC	.090	.157	1	100
66260392543	1090LMC	.090	.157	1	150
66260392556	1100CC	.100	.157	1/2	100
66260392554	1100FC	.100	.157	1/2	200
66260392561	1100LMC	.100	.157	1	150
66260392568	1105CC	.105	.157	1/2	100
66260392567	1105MC	.105	.157	1/2	150
66260392580	1110CC	.110	.157	1/2	100
66260392578	1110FC	.110	.157	1/2	200
66260392598	1120CC	.120	.157	1/2	100
66260392604	1125CC	.125	.157	1/2	100
66260392603	1125MC	.125	.157	1/2	150
66260392602	1125FC	.125	.157	1/2	200
66260392610	1130CC	.130	.197	1	100
66260392608	1130FC	.130	.197	1	200
66260392616	1135CC	.135	.236	N/A	100
66260392615	1135MC	.135	.236	N/A	150
66260392622	1140CC	.140	.236	N/A	100
66260392628	1156CC	.156	.236	N/A	100
66260392627	1156MC	.156	.236	N/A	150
66260392626	1156FC	.156	.236	N/A	200
66260392734	1171CC	.171	.236	N/A	100
66260392733	1171MC	.171	.236	N/A	150
66260392740	1187CC	.187	.312	N/A	100
66260392739	1187MC	.187	.312	N/A	150
66260392738	1187FC	.187	.312	N/A	200
66260392745	1203MC	.203	.312	N/A	150
66260392752	1218CC	.218	.312	N/A	100
66260392751	1218MC	.218	.312	N/A	150
66260392758	1250CC	.250	.312	N/A	100
66260392757	1250MC	.250	.312	N/A	150

PART #	PRODUCT #	HEAD DIAMETER INCHES	HEAD LENGTH	NECK LENGTH	GRIT SIZE
4000 Series – Diamond					
1/4" Shank x 3" Overall Length					
66260392630	4156CD	.156	.250	1	100
66260392629	4156FD	.156	.250	1	200
66260392634	4187CD	.187	.250	1	100
66260392633	4187FD	.187	.250	1	200
66260392638	4203CD	.203	.250	1	100
66260392642	4218CD	.218	.250	1	100
66260392641	4218FD	.218	.250	1	200
66260392646	4236CD	.236	.250	1	100
66260392645	4236FD	.236	.250	1	200
66260392650	4250CD	.250	.250	1	100
66260392649	4250FD	.250	.250	1	200
66260392654	4282CD	.282	.250	N/A	100
66260392653	4282FD	.282	.250	N/A	200
66260392658	4312CD	.312	.375	N/A	100
66260392657	4312FD	.312	.375	N/A	200
66260392662	4375CD	.375	.375	N/A	100
66260392661	4375FD	.375	.375	N/A	200
66260392666	4390CD	.390	.375	N/A	100
66260392670	4406CD	.406	.375	N/A	100
66260392674	4437CD	.437	.375	N/A	100
66260392678	4500CD	.500	.375	N/A	100
66260392677	4500FD	.500	.375	N/A	200
66260392682	4730CD	.730	.375	N/A	100
66260392690	41000CD	1.000	.375	N/A	100
66260392689	41000FD	1.000	.375	N/A	200
4000 Series – cBN					
1/4" Shank x 3" Overall Length					
66260392632	4156CC	.156	.250	1	100
66260392631	4156FC	.156	.250	1	200
66260392636	4187CC	.187	.250	1	100
66260392635	4187FC	.187	.250	1	200
66260392640	4203CC	.203	.250	1	100
66260392639	4203FC	.203	.250	1	200
66260392644	4218CC	.218	.250	1	100
66260392643	4218FC	.218	.250	1	200
66260392648	4236CC	.236	.250	1	100
66260392647	4236FC	.236	.250	1	200
66260392652	4250CC	.250	.250	1	100
66260392651	4250FC	.250	.250	1	200
66260392656	4282CC	.282	.250	N/A	100
66260392655	4282FC	.282	.250	N/A	200
66260392660	4312CC	.312	.375	N/A	100
66260392659	4312FC	.312	.375	N/A	200
66260392664	4375CC	.375	.375	N/A	100
66260392663	4375FC	.375	.375	N/A	200
66260392668	4390CC	.390	.375	N/A	100
66260392672	4406CC	.406	.375	N/A	100
66260392676	4437CC	.437	.375	N/A	100
66260392675	4437FC	.437	.375	N/A	200
66260392680	4500CC	.500	.375	N/A	100
66260392679	4500FC	.500	.375	N/A	200
66260392684	4730CC	.730	.375	N/A	100
66260392683	4730FC	.730	.375	N/A	200
66260392692	41000CC	1.000	.375	N/A	100

TARGET MARKET SYMBOLS
 ● = CERAMICS ▲ = TOOL & DIE ■ = COMPOSITES

Electroplated Mounted Points, Mandrels and Tapered Honers

DIAMOND AND cBN MOUNTED POINTS ● ▲

PART #	PRODUCT #	HEAD DIAMETER INCHES	HEAD LENGTH	GRIT SIZE
6000 Series – Diamond				
3/8" Shank x 3-3/4" Overall Length				
66260392694	6406CD	.406	.375	80
66260392693	6406MD	.406	.375	150
66260392698	6437CD	.437	.375	80
66260392697	6437MD	.437	.375	150
66260392702	6500CD	.500	.375	80
66260392701	6500MD	.500	.375	150
66260392706	6562CD	.562	.375	80
66260392710	6625CD	.625	.375	80
66260392709	6625MD	.625	.375	150
66260392718	6750CD	.750	.375	80
66260392717	6750MD	.750	.375	150
66260392721	6875MD	.875	.400	150
66260392726	61000CD	1.000	.500	80
66260392725	61000MD	1.000	.500	150

PART #	PRODUCT #	HEAD DIAMETER INCHES	HEAD LENGTH	GRIT SIZE
6000 Series – cBN				
3/8" Shank x 3-3/4" Overall Length				
66260392696	6406CC	.406	.375	80
66260392695	6406MC	.406	.375	150
66260392700	6437CC	.437	.375	80
66260392699	6437MC	.437	.375	150
66260392704	6500CC	.500	.375	80
66260392703	6500MC	.500	.375	150
66260392708	6562CC	.562	.375	80
66260392712	6625CC	.625	.375	80
66260392711	6625MC	.625	.375	150
66260392716	6687CC	.687	.375	80
66260392715	6687MC	.687	.375	150
66260392720	6750CC	.750	.375	80
66260392719	6750MC	.750	.375	150
66260392724	6875CC	.875	.400	80
66260392728	61000CC	1.000	.500	80
66260392727	61000MC	1.000	.500	150
9000 Series – Diamond				
3/4" Shank x 3-3/4" Overall Length				
66260308354	91000CD	1.000	.500	80

cBN HEAVY STOCK REMOVAL MANDRELS ▲

FEATURES	BENEFITS
■ Nickel alloy matrix	■ Tough, durable bond
■ Single layer of abrasive	■ Economical
■ Exposed particles	■ Aggressive cutting action
■ Super coarse abrasive grit	■ Long tool life

For heavy stock removal on jig, internal, and offhand operations on tool steels and hardened aerospace alloys.

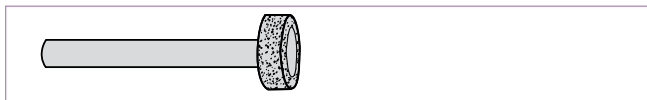

PART #	PRODUCT #	HEAD DIAMETER	HEAD LENGTH	SHANK DIAMETER	OVERALL LENGTH	GRIT SIZE
HSR Series – cBN						
66260395426	HSR-1/4	1/4	1/4	3/8	3	60
66260395428	HSR-3/8	3/8	3/8	3/8	3	60
66260395429	HSR-1/2	1/2	3/8	3/8	3-1/2	60
66260395431	HSR-3/4	3/4	3/8	3/8	3-1/2	60
66260395432	HSR-1	1	3/8	3/8	3-1/2	60

DIAMOND TAPERED HONES FOR DRAWING DIES ● ▲ ■

FEATURES	BENEFITS
■ Nickel alloy matrix	■ Tough, durable bond
■ Single layer of abrasive	■ Economical
■ Exposed particles	■ Aggressive cutting action

Used primarily for forming carbide drawing dies, but also can be used for small hole honing in ceramics, fiberglass, plastics, and composite materials.

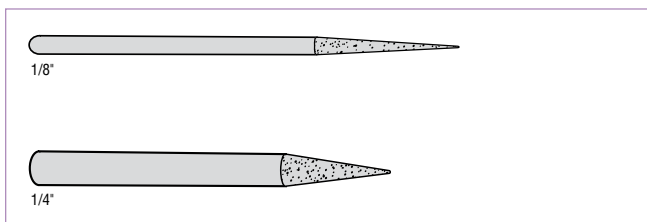

PART #	PRODUCT #	INCLUDED ANGLE	SHANK DIAMETER	GRIT SIZE
Tapered Honers for Drawing Dies – Diamond				
3" Overall Length				
66260395540	TH12-6MD	6°	1/8	150
66260395541	TH12-8MD	8°	1/8	150
66260363371	TH25-12CD	12°	1/4	100
66260395542	TH12-12MD	12°	1/8	150
66260395543	TH25-12MD	12°	1/4	150
66260395544	TH25-14MD	14°	1/4	150
66260395545	TH25-16MD	16°	1/4	150

TARGET MARKET SYMBOLS		
● = CERAMICS	▲ = TOOL & DIE	■ = COMPOSITES

Electroplated Micro Drills and Routers

DIAMOND MICRO DRILLS ● ▲ ■

FEATURES	BENEFITS
■ Nickel alloy matrix	■ Tough, durable bond
■ Single layer of abrasive	■ Economical
■ Exposed particles	■ Aggressive cutting action
■ M-Series	■ Carefully-sized, uniformly-shaped diamond particles are used on all M-Series drills
■ S-Series	■ Recommended for adapting to ultrasonic drill heads

A modification of Norton mounted points, these tools are specifically designed for drilling holes in the .007" to .065" diameter range. Perfect for drilling sapphire and high density alumina ceramics for hybrid micro-circuit substrates.

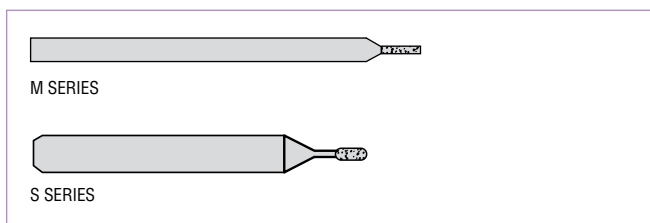

PART #	PRODUCT #	DIAMETER INCHES	HEAD LENGTH	OVERALL LENGTH	GRIT SIZE
M-Series Micro Drills – Diamond					
Shank Diameter .040" (1mm)					
66260395516	M7	.007	.028	11/16	600
66260395517	M10	.010	.049	11/16	400
66260395518	M12	.012	.056	13/16	325
66260395519	M15	.015	.077	13/16	325
S-Series Micro Drills – Diamond					
1/8" Shank x 1" Overall Length					
66260395520	S16FD	.016	.062	.093	200
66260392841	S18FD	.018	.062	.125	200
66260395521	S20FD	.020	.062	.125	200
66260395522	S25FD	.025	.093	.156	200
66260395523	S30MD	.030	.093	.156	150
66260395524	S35MD	.035	.093	.187	150
66260395525	S40MD	.040	.125	.218	150
66260395526	S45CD	.045	.125	.218	100
66260395527	S50CD	.050	.125	.250	100
66260395528	S60CD	.060	.125	.312	100
66260395529	S65CD	.065	.125	.312	100

DIAMOND ROUTERS ● ■

FEATURES	BENEFITS
■ Nickel alloy matrix	■ Tough, durable bond
■ Single layer of abrasive	■ Economical
■ Exposed particles	■ Aggressive cutting action

Used with hand operated tools, drill presses, and milling machines. Ideal for routing and reaming the highly-abrasive materials of alumina, fiberglass, plastics, and other nonmetallic composite materials.

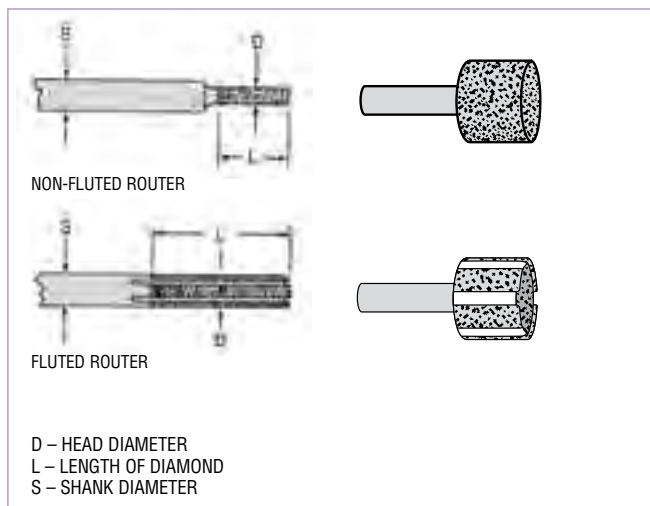

PART #	PRODUCT #	HEAD DIAMETER	LENGTH OF DIAMOND	SHANK DIAMETER	OVERALL LENGTH	GRIT SIZE
Non-Fluted Routers – Diamond						
66260364302	RNF1410CD	1/4	1	1/4	2-1/2	40
Fluted Routers – Diamond						
66260364310	RSF1812CD	1/8	1/2	1/4	2-1/2	60
66260364309	RSF1810CD	1/8	1	1/4	2-1/2	60
66260364308	RSF1412CD	1/4	1/2	1/4	2-1/2	40
66260364307	RSF1410CD	1/4	1	1/4	2-1/2	40
66260302715	RSF3412CD	3/4	1/2	1/2	2-1/2	40

TARGET MARKET SYMBOLS		
● = CERAMICS	▲ = TOOL & DIE	■ = COMPOSITES

Electroplated Mounted Contour Tools

DIAMOND AND CBN MOUNTED CONTOUR TOOLS ● ▲ ■

FEATURES	BENEFITS
■ Nickel alloy matrix	■ Tough, durable bond
■ Single layer of abrasive	■ Economical
■ Exposed particles	■ Aggressive cutting action
■ Variety of tool shapes available as stock	■ Satisfy most tool and die and deburring requirements

For contour grinding applications on carbide, ceramics, glass, ferrites, and many tough alloys and cements. Best suited for blending radii and deburring operations. Operating speeds: 15,000-20,000 RPM range.

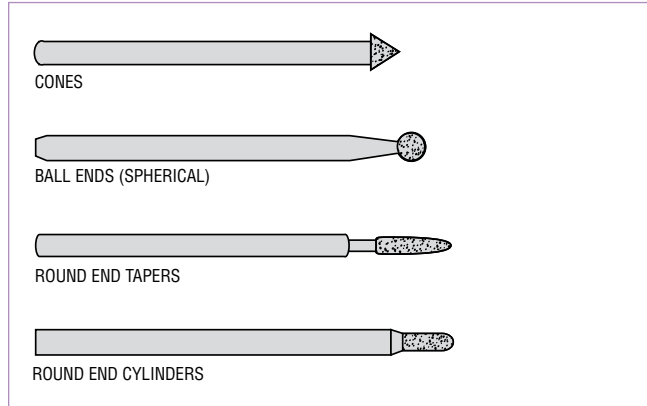

PART #	PRODUCT #	CONE BASE DIAMETER	INCLUDED ANGLE	CONE LENGTH	GRIT SIZE
Cones – Diamond					
1/8" Shank x 2" Overall Length					
66260395484	C14CD	1/8	14°	1/2	100
66260395488	C35CD	5/32	35°	1/4	100
66260395490	C60CD	11/64	60°	5/32	100
66260395492	C90CD	3/16	90°	3/32	100
Cones – cBN					
1/8" Shank x 2" Overall Length					
66260395483	C14CC	1/8	14°	1/2	100
66260395485	C26CC	3/16	26°	13/32	100
66260395487	C35CC	5/32	35°	1/4	100
66260395489	C60CC	11/64	60°	5/32	100
66260395491	C90CC	3/16	90°	3/32	100

PART #	PRODUCT #	BALL DIAMETER	GRIT SIZE
Ball Ends (Spherical) – Diamond			
1/8" Shank x 2" Overall Length			
66260395434	BE1CD	3/64	100
66260395436	BE2CD	1/16	100
66260395438	BE3CD	5/64	100
66260395440	BE4CD	3/32	100
66260395442	BE5CD	1/8	100
66260395444	BE6CD	3/16	100
66260395448	BE8CD	3/8	100
66260395450	BE9CD	1/2	100

PART #	PRODUCT #	BALL DIAMETER	GRIT SIZE
Ball Ends (Spherical) – cBN			
1/8" Shank x 2" Overall Length			
66260395437	BE3CC	5/64	100
66260395439	BE4CC	3/32	100
66260395441	BE5CC	1/8	100
66260395443	BE6CC	3/16	100
66260395445	BE7CC	1/4	100

PART #	PRODUCT #	SMALL HEAD DIAMETER	LARGE HEAD DIAMETER	HEAD LENGTH	INC. ANGLE	GRIT SIZE
Round End Tapers – Diamond						
1/8" Shank x 2" Overall Length						
66260395506	RT44CD	.044	.066	5/16	4°	100
66260395510	RT78CD	.078	.110	5/16	6°	100
Round End Tapers – cBN						
1/8" Shank x 2" Overall Length						
66260395509	RT78CC	.078	.110	5/16	6°	100

PART #	PRODUCT #	HEAD DIAMETER	HEAD LENGTH	GRIT SIZE
Round End Cylinders – Diamond				
1/8" Shank x 2" Overall Length				
66260395494	RE1CD	1/16	1/4	100
66260395496	RE2CD	5/64	1/4	100
66260395498	RE3CD	3/32	1/4	100
66260395500	RE4CD	1/8	1/4	100
66260395502	RE5CD	3/16	5/16	100
66260395504	RE6CD	1/4	5/16	100
Round End Cylinders – cBN				
1/8" Shank x 2" Overall Length				
66260395495	RE2CC	5/64	1/4	100

Type 6A2C cup and Type 01 straight bench and pedestal electroplated wheels are available as made-to order products. Contact your Norton representative for availability and quotation.

TARGET MARKET SYMBOLS
● = CERAMICS ▲ = TOOL & DIE ■ = COMPOSITES

Electroplated Files

DIAMOND MACHINE FILES ● ▲

FEATURES	BENEFITS
■ Nickel alloy matrix	■ Tough, durable bond
■ Single layer of abrasive	■ Economical
■ Exposed particles	■ Aggressive cutting action

For use in reciprocating hand profiling machines. Ideal for reworking and finishing carbide dies and molds, blending radii, and deburring and cleaning slots and grooves.

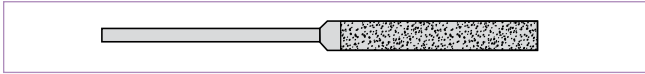

DIAMOND HAND FILES ● ▲

FEATURES	BENEFITS
■ Nickel alloy matrix	■ Tough, durable bond
■ Single layer of abrasive	■ Economical
■ Exposed particles	■ Aggressive cutting action

Indispensable aid for the toolroom. All purpose hand-held tool useful for deburring, notching, dressing, and honing hard, brittle materials.

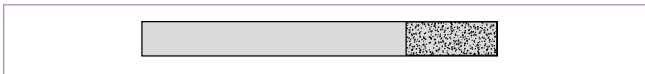

PART #	PRODUCT #	DIMENSIONS	ABRASIVE LOCATION	GRIT SIZE
Machine Files – Diamond				
5/8" Diamond Length, 1/8" Shank, 2" Overall Length				
66260395585	1ECD	.020 x .125		100
66260395586	2ECD	.030 x .125		100
66260395587	3ECD	.040 x .125		100
66260395589	3FCD	.120 x .040		100
66260395590	4FCD	.157 x .040		100
66260395591	5FCD	.203 x .078		100
66260395592	6FCD	.120 x .040		100
66260395593	1CCD	.098 x .196		100
66260395594	2CCD	.120 x .250		100
66260395596	3TCD	.127 side		100
66260395598	1RCD	.042 diam.		100
66260395599	2RCD	.080 diam.		100
66260395600	3RCD	.127 diam.		100

PART #	PRODUCT #	DIMENSIONS	ABRASIVE LOCATION	GRIT SIZE
Hand Files – Diamond				
6" Overall Length, 1-1/2" Diamond Length				
66260395605	DF1CD	1/8 x 1/8		100
66260395606	DF2CD	1/8 x 1/4		100
66260392843	DF2FD	1/8 x 1/4		200
66260395607	DF2WCD	1/8 x 1/4		100
66260395608	DF3CD	1/8 x 3/8		100
66260392844	DF3FD	1/8 x 3/8		200
66260395609	DF3WCD	1/8 x 3/8		100
66260364241	DF3SCD	1/8 x 1/2		100
66260395611	DF4CD	1/8		100
66260300134	DF4WCD	1/4		100
66260395613	DF5CD	1/8		100
66260392846	DF5FD	1/8		200
66260395614	DF5WCD	1/4		100
66260395615	DF6CD	1/8		100

TARGET MARKET SYMBOLS		
● = CERAMICS	▲ = TOOL & DIE	■ = COMPOSITES

Electroplated Files

DIAMOND NEEDLE FILES ● ▲

FEATURES	BENEFITS
■ Nickel alloy matrix	■ Tough, durable bond
■ Single layer of abrasive	■ Economical
■ Exposed particles	■ Aggressive cutting action

Indispensable aid for the toolroom. An all-purpose hand-held tool, useful for deburring, notching, dressing, and honing hard, brittle materials.

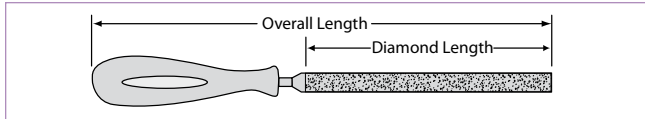

PART #	PRODUCT #	GRIT SIZE
NFK-6 Needle File Kit – Diamond		
66260364008	NFK-6	
Contains one each of the following:		
	NF1FD	200
	NF2FD	200
	NF3FD	200
	NF4FD	200
	NF5FD	200
	NF6FD	200
DFS-6 Die File Kit – Diamond		
66260391830	DFS-6	
Contains one each of the following:		
	1571	100
	1572	100
	1573	100
	1574	100
	1575	100
	1576	100

TARGET MARKET SYMBOLS
● = CERAMICS ▲ = TOOL & DIE ■ = COMPOSITES

PART #	PRODUCT #	DIMENSIONS	ABRASIVE LOCATION	SHAPE	GRIT SIZE
Needle Files – Diamond					
4-1/4" Diamond Length, 8-1/2" Overall Length					
66260302432	LNF2CD	.400 x .100		Equaling	100
66260305611	LNF2FD	.400 x .100		Equaling	200
66260302898	LNF3CD	.45 x .150		Half Round	100
66260305612	LNF3FD	.485 x .150		Half Round	200
2-3/4" Diamond Length, 5-3/4" Overall Length, With Handle					
66260391729	1571	.055 x .190		Flat	100
66260391730	1572	.075 x .210		Half Round	100
66260391731	1573	.145 x .145		Triangle	100
66260391732	1574	.100 x .100		Square	100
66260391733	1575	.120		Round	100
66260391734	1576	.055 x .190		Pointed Flat	100
3" Diamond Length, 5-1/2" Overall Length, With Handle					
66260395575	NF1FD	.150 x .105		Oval	200
66260395576	NF2FD	.218 x .072		Half Round	200
66260395577	NF3FD	.205 x .058		Equaling	200
66260395578	NF4FD	.096 x .096		Square	200
66260395579	NF5FD	.138 x .138		Triangle	200
66260395580	NF6FD	.118		Round	200

NEEDLE FILE SHAPE AND APPLICATION KEY:

- Barrette:** A triangle with diamond on the bottom side only
- Crossing:** Elongated oval, with more pointed ends than an oval file; has diamonds all around
- Equaling:** A rectangle with diamond on all four sides; ideal for filing both sides of an ID simultaneously
- Pointed Flat:** A cone with a flat top with diamond on the sides of the cone

Electroplated Drills

DIAMOND CORE DRILLS ● ■

FEATURES	BENEFITS
■ Nickel alloy matrix	■ Tough, durable bond
■ Single layer of abrasive	■ Economical
■ Exposed particles	■ Aggressive cutting action

High performance on glass and ceramic applications while providing fast, reliable cutting. Submersed drilling is highly recommended for optimum operating performance.



DIAMOND MOUNTED CORE DRILLS ● ■

FEATURES	BENEFITS
■ Nickel alloy matrix	■ Tough, durable bond
■ Single layer of abrasive	■ Economical
■ Exposed particles	■ Aggressive cutting action
■ Removable pilot (bulb-like extension)	■ Provides added stability
	■ Ensures smooth drilling with less wobbling
■ 1/8" wrap: additional 1/8" of electroplated diamond on the blade core	■ Increases life of blade on deep cuts, reduces binding and grinding on the core

High performance results on glass and ceramic applications.

DIAMOND TWIST DRILLS ● ■

FEATURES	BENEFITS
■ Nickel alloy matrix	■ Tough, durable bond
■ Single layer of abrasive	■ Economical
■ Exposed particles	■ Aggressive cutting action

Recommended for precision drilling on circuit boards containing fiberglass, nylon, and similar tough, abrasive materials. Diamond twist drills are also useful for drilling plastics and resin composites and have been successful in drilling soft ductile materials as well as "green" carbide. Operating procedures are similar to those of standard twist drills.

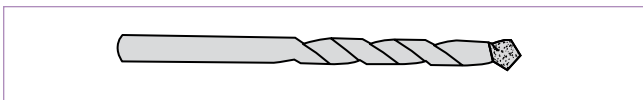

PART #	PRODUCT #	OUTER DIAMETER	INNER DIAMETER	GRIT SIZE
Core Drills – Diamond				
Straight Tube Type, 2" Overall Length				
66260395530	A1MD	1/16	.023	150
66260395531	A2MD	3/32	.048	150
66260395532	A3MD	1/8	.075	150
66260395533	A4MD	5/32	.110	150
66260395534	A5CD	3/16	.140	100
66260395535	A6CD	1/4	.195	100
66260395536	A7CD	5/16	.255	100
66260395537	A8CD	3/8	.325	100

PART #	PRODUCT #	OUTER DIAMETER	INNER DIAMETER	GRIT SIZE
Mounted Core Drills – Diamond				
1/8" Wrap, 3/8" Shank Diameter, 3.45" Overall Length				
66260392850	CD.750	3/4	1/4	40

PILOTS ARE REMOVABLE.

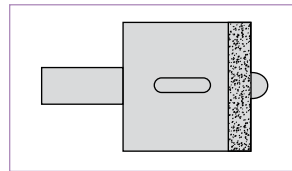

PART #	PRODUCT #	DRILL DIAMETER	DRILL LENGTH	GRIT SIZE
Twist Drills – Diamond				
66260395549	TW-1/16	1/16	1-3/4	100
66260395550	TW-1/8	1/8	2-3/4	100
66260395551	TW-1/4	1/4	4	100
66260395552	TW-3/8	3/8	5	100

DIAMETER TOLERANCE EQUALS + OR - 1/64.

TARGET MARKET SYMBOLS

● = CERAMICS ▲ = TOOL & DIE ■ = COMPOSITES

Electroplated Saw Blades

DIAMOND CONTINUOUS RIM CUT-OFF SAW BLADES ■

FEATURES	BENEFITS
■ Nickel alloy matrix	■ Tough, durable bond
■ Single layer of abrasive	■ Economical
■ Exposed particles	■ Aggressive cutting action

Ideal for cutting-off highly-abrasive materials such as alumina, fiberglass, plastics, and other nonmetallic composite materials.

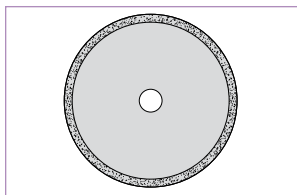

Additional diamond continuous rim and slotted cut-off saw blades, with extended wraps to avoid binding, are available as made-to-order products. Please contact your Norton representative.

DIAMOND SLOTTED CUT-OFF SAW BLADES ■

FEATURES	BENEFITS
■ Nickel alloy matrix	■ Tough, durable bond
■ Single layer of abrasive	■ Economical
■ Exposed particles	■ Aggressive cutting action
■ 3/4" wrap: additional 3/4" of electroplated diamond on the blade core	■ Increases life of blade on deep cuts, reduces binding and grinding on the core

Ideal for cutting-off highly-abrasive materials such as alumina, fiberglass, plastics, and other nonmetallic composite materials.

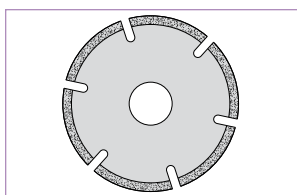

Additional diamond continuous rim and slotted cut-off saw blades, with extended wraps to avoid binding, are available as made-to-order products. Please contact your Norton representative.

DIAMOND MOUNTED SAW BLADES ■

FEATURES	BENEFITS
■ Nickel alloy matrix	■ Tough, durable bond
■ Single layer of abrasive	■ Economical
■ Exposed particles	■ Aggressive cutting action

Ideal for cutting-off highly-abrasive materials such as alumina, fiberglass, plastics, and other nonmetallic composite materials.

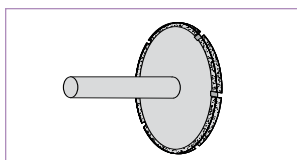

PART #	PRODUCT #	DIAM.	OVERALL THICKNESS	HOLE SIZE	GRIT SIZE
Continuous Rim Cut-off Saw Blades – Diamond					
66260301990	DS2062-250	2	1/16	1/4	40
66260391474	DS2094-250	2	3/32	1/4	40
66260391473	DS3094-250	3	3/32	1/4	40
66260363036	DS3094-375	3	3/32	3/8	40
66260395554	DS4094-500	4	3/32	1/2	40
66260300197	DS4094-750	4	3/32	3/4	40
66260395557	DS8094-625	8	3/32	5/8	40

PART #	PRODUCT #	DIAM.	OVERALL THICKNESS	HOLE SIZE	GRIT SIZE
Slotted Cut-off Saw Blades – Diamond					
66260301989	DSS2062-250	2	1/16	1/4	40
66260364258	DSS3094-250	3	3/32	1/4	40
66260363015	DSS4094-375	4	3/32	3/8	40
66260395559	DSS4094-500	4	3/32	1/2	40
66260395560	DSS6094-500	6	3/32	1/2	40
66260362981	DSS10125-625	10	1/8	5/8	40
66260395563	DSS12125-500	12	1/8	1/2	40
66260364253	DSS14156-500	14	5/32	1/2	40
66260362989	DSS14156-1	14	5/32	1	40
66260395565	DSS16156-1	16	5/32	1	40
66260395566	DSS18156-1	18	5/32	1	40
Slotted Cut-off Saw Blades with 3/4" Wrap – Diamond					
66260313423	DSSW4094-750	4	3/32	3/4	40

PART #	PRODUCT #	DIAM.	OVERALL THICKNESS	HOLE SIZE	GRIT SIZE
Mounted Saw Blades – Diamond					
2" Overall Length					
66260395422	MDS1CD	1	3/32	1/4	40
66260395423	MDS1-1/2CD	1-1/2	3/32	1/4	40
66260395424	MDS2CD	2	3/32	3/8	40

TARGET MARKET SYMBOLS		
● = CERAMICS	▲ = TOOL & DIE	■ = COMPOSITES



CATEGORY DEFINITION

Norton diamond lapping compound polishes all materials – hard and soft. Diamond powders are uniformly distributed in a liquid vehicle for aggressive polishing and consistent part quality. Easy-to-use plastic syringe for quick clean-up.

APPLICATIONS: For mold, die, and tool polishing, polishing to final tolerance of ceramic parts, initial charging of lapping plates and discs, and other processes that require mirror finish and close tolerance performance.

SYRINGE SIZE: 5 and 18 gram syringes

TYPE: Water soluble – when soap/water is used for clean-up
Oil soluble – when solvent is used for clean-up

PRODUCT #	MICRON GRADE	COLOR	PART #	
Diamond Compound – Water Soluble				
5 Gram Syringes				
5PS1/4WSSTD	1/4	Ultra Fine	Gray	66260300362
5PS1/2WSSTD	1/2	Ultra Fine	Lt. Gray	66260300417
5PS1WSSTD	1	Ultra Fine	Ivory	66260300368
5PS3WSSTD	3	Super Fine	Yellow	66260300667
5PS6WSSTD	6	Super Fine	Orange	66260300372
5PS9WSSTD	9	Super Fine	Green	66260300375
5PS12WSSTD	12	Super Fine	Aqua	66260300376
5PS15WSSTD	15	Fine	Blue	66260300379
5PS20WSSTD	20	Fine	Auburn	66260300381 *
5PS30WSSTD	30	Fine	Red	66260300383
5PS45WSSTD	45	Fine	Brown	66260300384
5PS60WSSTD	60	Fine	Purple	66260300388
5PS90WSSTD	90	Fine	Black	66260300389
18 Gram Syringes				
18PS1/4WSSTD	1/4	Ultra Fine	Gray	66260300392
18PS1/2WSSTD	1/2	Ultra Fine	Lt. Gray	66260300394
18PS1WSSTD	1	Ultra Fine	Ivory	66260300396
18PS3WSSTD	3	Super Fine	Yellow	66260300398
18PS6WSSTD	6	Super Fine	Orange	66260300400
18PS9WSSTD	9	Super Fine	Green	66260300402
18PS12WSSTD	12	Super Fine	Aqua	66260300404 *
18PS15WSSTD	15	Fine	Blue	66260300406
18PS20WSSTD	20	Fine	Auburn	66260300408
18PS30WSSTD	30	Fine	Red	66260300410 *
18PS45WSSTD	45	Fine	Brown	66260300412 *
18PS60WSSTD	60	Fine	Purple	66260300414 *
18PS90WSSTD	90	Fine	Black	66260300416 *

PRODUCT #	MICRON GRADE	COLOR	PART #	
Diamond Compound – Oil Soluble				
5 Gram Syringes				
5PS1/4OSSTD	1/4	UltraFine	Gray	61463691123 *
5PS1/2OSSTD	1/2	UltraFine	Lt. Gray	66260300363
5PS1OSSTD	1	UltraFine	Ivory	61463691133
5PS3OSSTD	3	Super Fine	Yellow	61463691138
5PS6OSSTD	6	Super Fine	Orange	61463691143
5PS9OSSTD	9	Super Fine	Green	61463691148
5PS12OSSTD	12	Super Fine	Aqua	66260300377 *
5PS15OSSTD	15	Fine	Blue	61463691153
5PS20OSSTD	20	Fine	Auburn	66260300380 *
5PS30OSSTD	30	Fine	Red	61463691158
5PS45OSSTD	45	Fine	Brown	61463691163
5PS60OSSTD	60	Fine	Purple	66260300386
5PS90OSSTD	90	Fine	Black	66260300390
18 Gram Syringes				
18PS1/4OSSTD	1/4	UltraFine	Gray	66260300391
18PS1/2OSSTD	1/2	UltraFine	Lt. Gray	66260300393 *
18PS1OSSTD	1	UltraFine	Ivory	61463691134 *
18PS3OSSTD	3	Super Fine	Yellow	61463691139
18PS6OSSTD	6	Super Fine	Orange	66260300399
18PS9OSSTD	9	Super Fine	Green	61463691149 *
18PS12OSSTD	12	Super Fine	Aqua	66260300403 *
18PS15OSSTD	15	Fine	Blue	61463691154
18PS20OSSTD	20	Fine	Auburn	66260300407
18PS30OSSTD	30	Fine	Red	66260300409
18PS45OSSTD	45	Fine	Brown	61463691164 *
18PS60OSSTD	60	Fine	Purple	66260300413
18PS90OSSTD	90	Fine	Black	66260300415

* NON-STOCK; CONTACT YOUR NORTON REPRESENTATIVE FOR CURRENT LEAD-TIMES.

Marking System

5 PS 1/4 OS STD

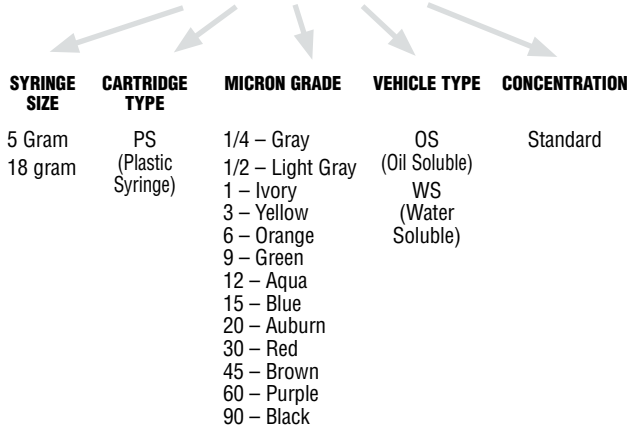

SPECcheck

DIAMOND COMPOUND APPLICATION GUIDE

APPLICATION	MICRON GRADE	MICRON RANGE	MESH SIZE EQUIVALENT	COLOR	CONC.
ULTRA FINE Applying finest finishes on metals and ceramics	1/4	(0-1/2)	100,000	Gray	Std.
	1/2	(0-1)	60,000	Lt. Gray	Std.
	1	(0-2)	14,000	Ivory	Std.
SUPER FINE Final finishing of dies, molds, seals, most applications (RMS 4-12)	3	(2-4)	8,000	Yellow	Std.
	6	(4-8)	3,000	Orange	Std.
	9	(8-12)	1,800	Green	Std.
	12	(9-15)	1,500	Aqua	Std.
FINE FINISH Preparatory lapping (RMS 12-20)	15	(12-22)	1,200	Blue	Std.
	20	(15-25)	800	Auburn	Std.
	30	(22-36)	600	Red	Std.
	45	(36-45)	325	Brown	Std.
	60	(54-80)	230	Purple	Std.
	90	(80-100)	170	Black	Std.

Safety – It's the Smart Thing to Do



SPEEDS

Check machine spindle speed and speed listed on machine against safe maximum operating speed marked on the grinding wheel. Do not overspeed the wheel.



FACE PROTECTION

Always wear government-approved face and eye protection when using abrasive products.



SAFETY GLOVES

Grinding applications are conducted in harsh environments. The use of proper fitting gloves is recommended.



WHEEL GUARD

Always use the wheel guard as supplied by the machine manufacturer, in the proper position.

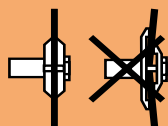

FLANGES

When mounting most grinding wheels, use flanges of equal diameter and bearing surface. For exceptions, see ANSI B7.1.



HEARING PROTECTION

Use of abrasive products may create elevated sound levels. Hearing protection must be worn where required.



SAFETY GUIDES, MSDS AND WHEEL WARNING MESSAGES

Before using any abrasive materials, READ:

- The Safety Guides
- Wheel Warning Messages
- Material Safety Data Sheets (MSDS)

Norton provides information pertaining to the safe use of all products. Please take the time to read it carefully. Contact suppliers of the workpiece and abrasive materials for copies of the MSDS if one is not readily available. Norton abrasives MSDS can be obtained on www.nortonabrasives.com



DUST PROTECTION

Exposure to dust generated from workpiece and/or abrasive materials can result in lung damage and/or other physical injury.

Use dust capture or local exhaust as stated in the MSDS. Wear government-approved respiratory protection and eye and skin protection.

Failure to follow this warning can result in serious lung damage and/or physical injury.

This is a general dust warning and does not cover specific situations. For more information, refer to the MSDS dust warning provided with your products, and workpiece.



WARNING

This warning icon appears on our products and packaging. It is intended to draw your attention to the specific safety warning practices outlined after it.



PISTOL GRIP AIR SANDER

A DEADLY EQUATION

Pistol Grip Air Sander + Grinding Wheel = Certain Injury!

- Never use a high speed air sander as a portable grinder
- Use only sanding discs specifically designed for sanders
- Because the speed of these sanders far exceeds the maximum rated speeds for grinding wheels, a potentially lethal wheel breakage may occur

Conversion Table – Wheel Speeds

REVOLUTIONS PER MINUTE FOR VARIOUS DIAMETERS OF GRINDING WHEELS TO GIVE SURFACE SPEED IN FEET PER MINUTE AS INDICATED
 (FOR WHEEL MARKING PURPOSES THE CALCULATED RPM FIGURES LISTED BELOW ARE ROUNDED OFF TO THE NEXT 5)

Diameter of Wheel in Inches	Surface Speed in Feet Per Minute (SFPM)																				
	4,000	4,500	5,000	5,500	6,000	6,500	7,000	7,500	8,000	8,500	9,000	9,500	10,000	12,000	12,500	14,200	16,000	16,500	17,000	19,685	20,000
1	15,279	17,189	19,098	21,008	22,918	24,828	26,737	28,647	30,558	32,467	34,377	36,287	38,196	45,836	47,745	54,240	61,116	63,025	64,935	75,190	76,395
2	7,639	8,594	9,549	10,504	11,459	12,414	13,368	14,323	15,278	16,233	17,188	18,143	19,098	22,918	23,873	27,120	30,558	31,510	32,465	37,595	38,195
3	5,093	5,729	6,366	7,003	7,639	8,276	8,913	9,549	10,186	10,822	11,459	12,096	12,732	15,278	15,915	18,080	20,372	21,010	21,645	25,065	25,465
4	3,820	4,297	4,775	5,252	5,729	6,207	6,685	7,162	7,640	8,116	8,595	9,072	9,549	11,459	11,940	13,560	15,278	15,755	16,235	18,800	19,100
5	3,056	3,438	3,820	4,202	4,584	4,966	5,348	5,730	6,112	6,494	6,876	7,258	7,640	9,168	9,550	10,850	12,224	12,605	12,985	15,040	15,280
6	2,546	2,865	3,183	3,501	3,820	4,138	4,456	4,775	5,092	5,411	5,729	6,048	6,366	7,639	7,960	9,040	10,186	10,505	10,820	12,530	12,730
7	2,183	2,455	2,728	3,001	3,274	3,547	3,820	4,092	4,366	4,638	4,911	5,183	5,456	6,548	6,820	7,750	8,732	9,005	9,275	10,740	10,915
8	1,910	2,148	2,387	2,626	2,865	3,103	3,342	3,580	3,820	4,058	4,297	4,535	4,775	5,729	5,970	6,780	7,640	7,880	8,115	9,400	9,550
9	1,698	1,910	2,122	2,334	2,546	2,758	2,970	3,182	3,396	3,606	3,820	4,032	4,244	5,092	5,305	6,030	6,792	7,000	7,215	8,355	8,490
10	1,528	1,719	1,910	2,101	2,292	2,483	2,674	2,865	3,056	3,247	3,438	3,629	3,820	4,584	4,775	5,425	6,112	6,300	6,495	7,520	7,640
12	1,273	1,432	1,591	1,751	1,910	2,069	2,228	2,386	2,546	2,705	2,864	3,023	3,183	3,820	3,980	4,520	5,092	5,250	5,410	6,265	6,365
14	1,091	1,228	1,364	1,500	1,637	1,773	1,910	2,046	2,182	2,319	2,455	2,592	2,728	3,274	3,410	3,875	4,366	4,500	4,640	5,370	5,455
16	955	1,074	1,194	1,313	1,432	1,552	1,672	1,791	1,910	2,029	2,149	2,268	2,387	2,865	2,985	3,390	3,820	3,940	4,060	4,700	4,775
18	849	955	1,061	1,167	1,273	1,379	1,485	1,591	1,698	1,803	1,910	2,016	2,122	2,546	2,655	3,015	3,396	3,500	3,605	4,175	4,245
20	764	859	955	1,050	1,146	1,241	1,337	1,432	1,528	1,623	1,719	1,814	1,910	2,292	2,390	2,715	3,056	3,150	3,245	3,760	3,820
22	694	781	868	955	1,042	1,128	1,215	1,302	1,388	1,476	1,562	1,649	1,736	2,084	2,170	2,465	2,776	2,865	2,950	3,420	3,470
24	637	716	796	875	955	1,034	1,115	1,194	1,274	1,353	1,433	1,512	1,591	1,910	1,990	2,260	2,546	2,625	2,705	3,135	3,185
26	588	661	734	808	881	955	1,028	1,101	1,176	1,248	1,322	1,395	1,468	1,762	1,840	2,090	2,352	2,425	2,495	2,890	2,940
28	546	614	682	750	818	887	955	1,023	1,092	1,159	1,228	1,296	1,364	1,637	1,705	1,940	2,182	2,250	2,320	2,685	2,730
30	509	573	637	700	764	828	891	955	1,018	1,082	1,146	1,210	1,274	1,528	1,595	1,810	2,056	2,100	2,165	2,505	2,545
32	477	537	597	656	716	776	836	895	954	1,014	1,074	1,134	1,194	1,432	1,495	1,695	1,910	1,970	2,030	2,350	2,385
34	449	505	562	618	674	730	786	843	898	955	1,011	1,067	1,124	1,348	1,405	1,595	1,796	1,855	1,910	2,210	2,245
36	424	477	530	583	637	690	742	795	848	902	954	1,007	1,061	1,273	1,330	1,510	1,698	1,750	1,085	2,090	2,120
38	402	452	503	553	603	653	704	754	804	854	904	955	1,006	1,206	1,260	1,430	1,608	1,660	1,710	1,980	2,010
40	382	430	478	525	573	620	669	716	764	812	860	908	956	1,146	1,195	1,355	1,528	1,575	1,625	1,880	1,910
42	366	409	454	500	545	591	636	682	732	775	818	863	908	1,090	1,140	1,295	1,464	1,500	1,545	1,790	1,820
44	347	390	434	478	521	564	608	651	694	737	780	824	868	1,042	1,085	1,235	1,388	1,432	1,475	1,710	1,735
46	333	375	416	458	500	541	582	624	666	708	750	791	832	1,000	1,040	1,180	1,332	1,370	1,410	1,635	1,660
48	318	358	398	438	478	517	558	597	636	676	716	756	796	956	995	1,130	1,272	1,315	1,350	1,565	1,590
53	288	324	360	395	432	468	503	539	576	612	648	683	720	864	900	1,025	1,152	1,189	1,225	1,420	1,440
60	255	287	319	350	387	414	446	478	510	542	574	606	638	774	795	905	1,020	1,050	1,080	1,255	1,275
72	212	239	265	291	318	345	371	398	424	451	477	504	530	637	665	755	849	875	905	1,045	1,060

For intermediate diameters not listed use the formula listed in Section 1.2.10 of ANSI B7.1 (SFPM = .262 x wheel diameter in inches x RPM.)
 To convert meters per second (m/s) to SFPM: m/s x 196.85 = SFPM. To convert SFPM to m/s: SFPM/196.85 = m/s. To convert RPM to SFPM: Wheel Diameter x RPM x 0.262 = SFPM



Product Warranty

WARRANTY – Norton warrants the products in this catalog to be free from defects in material or workmanship for a period of one year from the date of purchase. Norton's sole obligation under this warranty shall be to repair or replace, at Norton's option, any product which is non-conforming provided any such product failure was not caused by a subsequent modification of the product, misuse or a failure to follow any applicable instructions for the product.

EXCEPT FOR THE FOREGOING, NORTON EXPRESSLY DISCLAIMS ALL OTHER GUARANTIES AND/OR WARRANTIES, EXPRESS OR IMPLIED, INCLUDING THE WARRANTIES OF MERCHANTABILITY AND FITNESS FOR A PARTICULAR PURPOSE.

Product Quality Complaints

All product quality complaints should be submitted to your local Norton Distributor.

Liability Limitation

NORTON'S LIABILITY FOR ANY LOSS OR DAMAGE ARISING OUT OF OR RESULTING FROM THE USE OF THE PRODUCT SHALL NOT EXCEED THE PURCHASE PRICE THEREOF, REGARDLESS OF WHETHER SUCH LIABILITY ARISES IN CONTRACT, TORT (INCLUDING WITHOUT LIMITATION NEGLIGENCE OR STRICT LIABILITY), OR OTHERWISE, AND IN NO EVENT SHALL NORTON BE LIABLE FOR INDIRECT, SPECIAL, INCIDENTAL OR CONSEQUENTIAL DAMAGES OF ANY KIND. NO REPRESENTATIVE OF NORTON, NOR ANY OF NORTON'S DISTRIBUTORS OR DEALERS, IS AUTHORIZED TO MODIFY THIS WARRANTY OR ISSUE ANY WARRANTY REGARDING THE PRODUCTS IN THIS CATALOG.

Trademarks

All trademarks used in these pages are trademarks of Saint-Gobain Abrasives unless otherwise indicated.

3X™	Fantastic Tool™	NORaX®	Rapid Prep™
A275 Original Performance™	Fast Cut™	Norbide®	Rapid Strip™
Abrasive Connection Expressx®	FastEco™	NorKut™	Red Heat®
Abrasotex™	FastTrack™	NorGrip®	Rescue Runner™
Adalox®	FlexDrum™	NorLok™	Reshaping Your World™
Alundum®	FlexEdge™	NorPor®	RightCut™
Aero-Jet™	Foundry X™	Norton®	SAABA™
Amplex®	Free Cut®	Norton Clipper™	Sand-O-Flex™
AVOS®	Furioso™	Norton Design® (Parallelogram)	SandWet™
Aztec®	Gemini®	Norton Design® (Triple Stripe Design)	Screen-Bak®
Aztec li®	G-Force™	Norton Ice™	ShurStik™
Bear-Tex®	Green Flipper™	Norton Quantum™	Silver Eagle®
Black Ice®	Greenlyte™	Norton Quantum X™	SoftTouch®
Blaze®	Grind-O-Flex™	Norton SG®	Speed Change™
Blue-Bak™	India®	NorZon®	Speed-Lok®
Blue-Core™	JobPack™	NorZon BlueFire®	Stick & Sand®
BlueFire®	Lightning®	NorZon Plus®	Targa®
BlueFire 20X™	Liquid Ice®	Onyx™	The Absolute Force™
BZX®	Long Life™	Openkote™	The See-Thru System™
Charger™	Merit®	Pacester™	Thin Flex™
Clean Bond™	Metalite®	Paradigm®	TufBak®
Clear Choice™	Mini-Dex™	Plyweld®	U-Dex-It™
Clear Creek™	MSL®	PowerFlex®	Univel®
CloseKote®	Multi-Air®	PowerLock®	USB™
Crystolon®	Multi-Air Cyclonic®	PowerStrip™	Vitrium ³ ®
DiaLast™	Multi-Air® Plus™	Pure Ice™	Vortex®
Dry Ice®	Multi-Oilstone®	PureSand®	Winter®
Duo®	MultiSand™	Quadro-Fit Pro™	WoodSand™
Durite®	The Muscle Behind The Machine®	QuadroFlex™	ZF®
Edger™	Nanozyte™	Rail Cut™	ZS®
Elgin™	Neon®	Rapid Blend™	ZX®
EZ Choice™	NEX™	Rapid Cut™	and others
E-Z Flex®	No-Fil®	Rapid Finish™	
FabCut™			

GET ACCESS TO THE INDUSTRY'S BEST SELECTION OF ABRASIVE SOLUTIONS!



Norton | Saint-Gobain is so confident of the superior performance of our abrasive products, as recommended for specific applications, that we invite in-plant tests against any other brand of abrasive product on the market.

- 1 The test will be conducted in the user's own plant, on their own machines, using their own workpieces
- 2 Even if the user purchases only a minimum quantity of Norton abrasive products, the user will receive the same quantity discount as would apply to their normal production orders
- 3 If the Norton product tested proves completely unsatisfactory, the user will receive a full refund
- 4 If the Norton product tested performs at a lower level than the product presently in production, the user will receive an adjustment to make up the difference in performance
- 5 The user is the final judge of performance!

Customer Service

TO PLACE AN ORDER, contact our customer service support center with:

- Customer number and contact name
- Any special shipping needs
- Complete product information:
 - 11-digit Part Number
 - Product description
 - Quantity and unit of measure
 - Price by unit of measure

To ensure minimal errors and faster turnaround, using electronic media is preferred. For assistance with www.abrasiveconnection.com or EDI setup, contact us at:

Email: abrasive.connection@saint-gobain.com

Phone: **888-383-2236**

EMAIL: nacustomerservice@saint-gobain.com

U.S. PHONE: **800-551-4413** FAX: **800-551-4416**

CDN. PHONE: **800-263-6565** FAX: **800-561-9490**



Online

This printed catalog is a great starting resource for Norton and Merit product selection. Our website is the ideal resource for a more comprehensive outline of product and application information. It is continually updated with all our most current information and offers more electronic queries for deeper detail, at a click of a button.

[WWW.nortonabrasives.com](http://www.nortonabrasives.com)



NORTON | FULL LINE OF STOCK ABRASIVE PRODUCTS

RESHAPING THE WORLD FOR INDUSTRIAL MARKETS

For nearly 130 years, Norton products have delivered industry-leading abrasive solutions to consistently improve part quality finish and enhance production capabilities. The Norton brand has you covered for consistent-performing products that offer the highest productivity in the industry while reducing the overall total cost of doing business. **Call, click or visit us online to learn how.**



The Right Choice Every Time

The re-engineered Norton Gemini RightCut 100% aluminum oxide wheels provide thinner, faster cutting with a burr-free, precision cut and improved operator comfort.



A Quantum Leap in Technology

A new generation of Norton Quantum ceramic abrasive products are designed for maximizing performance and cost savings in precision grinding.



It's Time to Clear the Air

The precision laser-cut, spiral-hole design of Norton Multi-Air Cyclonic ceramic paper discs maximize dust extraction for a superior surface finish and cleaner work environment.



Power Up Affordable Versatility

The proprietary grain technology and improved resin bond in our Norton Neon products deliver up to 3X the life and cut rate at an economical initial price.



Prep for the Future

Cleaning and surface conditioning Norton Rapid Prep products deliver higher material removal, longer life and consistent, smear-free finishes - even on high nickel content alloys.



A Paradigm Shift in Manufacturing

Online truing and dressing capability results in lower cutting energies with highest quality part edges and finish. Choose Norton Paradigm stock or custom-manufactured to your exact requirements.

BEST

Highest Productivity - Lowest Total Cost

BETTER

Excellent Blend of Performance and Price

GOOD

Consistent Performance - Low Initial Price

www.facebook.com/NortonIndustrial | www.youtube.com/NortonIndustrial | www.nortonindustrial.com

USA CUSTOMER SERVICE:

Toll Free Phone: 1 (800) 551-4413
Toll Free Fax: 1 (800) 551-4416

CANADA CUSTOMER SERVICE:

Toll Free Phone: 1 (800) 263-6565
Toll Free Fax: 1 (800) 561-9490

FORM #7362 REV. 01/15

© Saint-Gobain January 2015.
Norton is a registered trademark of Saint-Gobain.

